

2N5038, 2N5039, 2N6496

File Number 698

High-Current, High-Power High-Speed Silicon N-P-N Planar Transistors

Devices for Switching and Amplifier Circuits in Industrial and Commercial Applications

Features:

- Maximum operating area curves for dc and pulse operation
- I_{SP} -limit line beginning at 28 V
- High collector current rating
- High-dissipation capability

RCA-2N5038, 2N5039 and 2N6496 are epitaxial silicon n-p-n planar transistors. They differ in breakdown-voltage ratings, leakage-current, and dc-beta values.

The high current-handling capability of these transistors in conjunction with fast switching speeds make these devices especially suited for switching-control amplifiers, power gates, switching regulators, converters, and inverters. Other recommended applications include dc-rf amplifiers and power oscillators. These transistors are supplied in the JEDEC TO-204AA package.

TERMINAL DESIGNATIONS

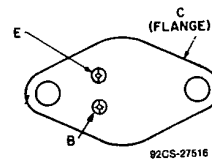

JEDEC TO-204AA

MAXIMUM RATINGS, Absolute-Maximum Values:

	2N5038	2N5039	2N6496	
*COLLECTOR-TO-BASE VOLTAGE V_{CBO}	150	120	150	V
COLLECTOR-TO-EMITTER SUSTAINING VOLTAGE:				
With - 1.5 volts (V_{BE}) of reverse bias and external base-to-emitter resistance (R_{BE}) = 100 Ω $V_{CEX(sus)}$	150	120	-	V
With $R_{BE} \leq 50 \Omega$ $V_{CER(sus)}$	110	95	130	V
With base open $V_{CEO(sus)}$	90	75	110	V
*EMITTER-TO-BASE VOLTAGE V_{EBO}	7	7	7	V
*CONTINUOUS COLLECTOR CURRENT I_C	20	20	15	A
*PEAK COLLECTOR CURRENT I_{CM}	30	30	-	A
*CONTINUOUS BASE CURRENT I_B	5	5	5	A
*TRANSISTOR DISSIPATION: P_T				
At case temperatures up to 25°C and V_{CE} up to 28 V	140	140	140	W
At case temperature of 100°C and V_{CB} of 20 V	80	80	80	W
At case temperatures up to 25°C and V_{CE} above 28 V	← See Fig. 1. →			
At case temperatures above 25°C and V_{CE} above 28 V	← See Figs. 1 & 2. →			
*TEMPERATURE RANGE:				
Storage & Operating (Junction)	← -65 to 200 →			°C
PIN TEMPERATURE (During Soldering)				
At distances $\geq 1/32$ in. (0.8 mm) from seating plane for 10 s max.	← 230 →			°C

*In accordance with JEDEC registration data format (JS-6, RDF-1)

2N5038, 2N5039, 2N6496

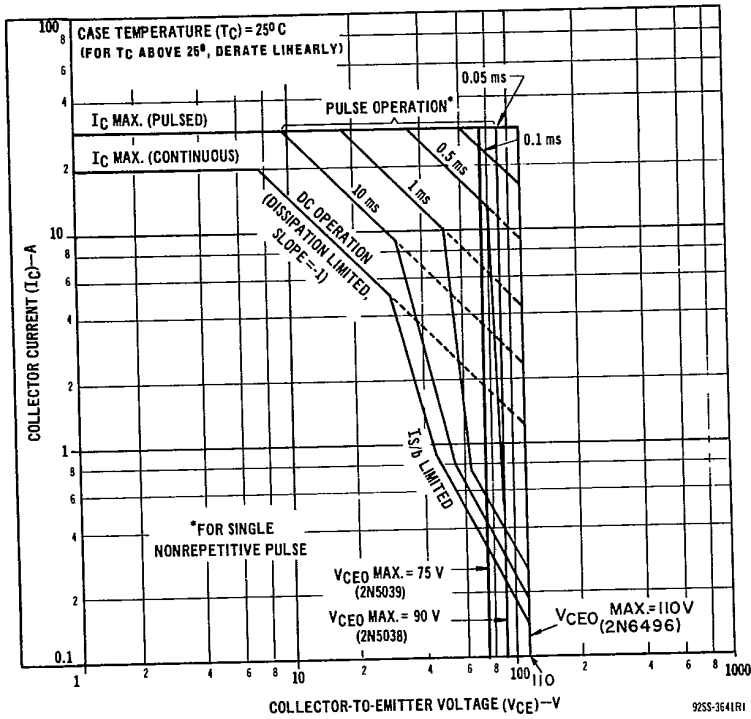

Fig. 1 — Maximum operating areas for all types.

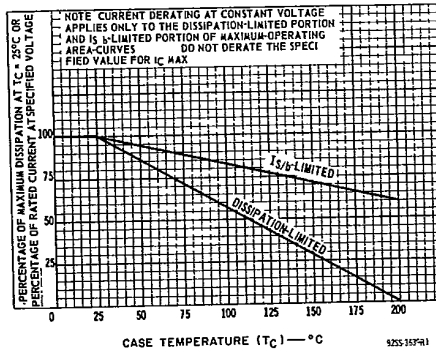

Fig. 2 — Dissipation derating curves for all types.

2N5038, 2N5039, 2N6496

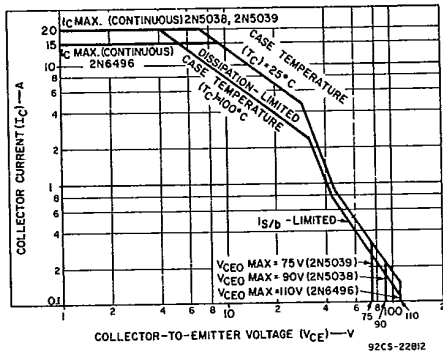

Fig. 3 - Maximum operating areas for all types.

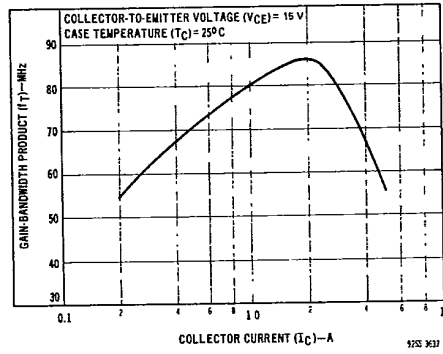

Fig. 4 - Typical gain-bandwidth product for all types.

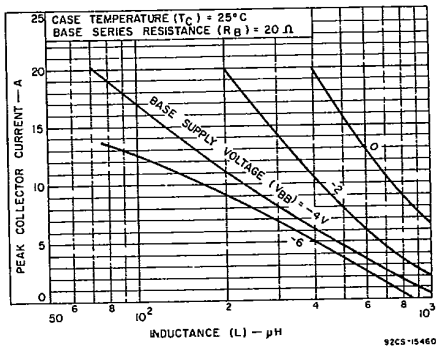

Fig. 5 - Maximum reverse-bias, second-breakdown characteristics for 2N5038 and 2N5039.

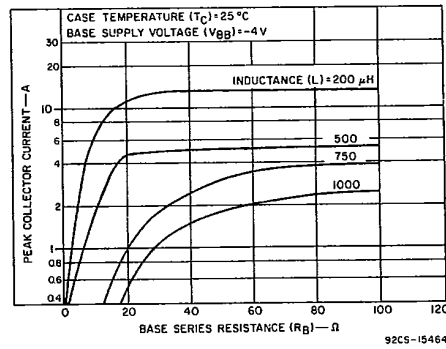

Fig. 6 - Maximum reverse-bias, second-breakdown characteristics for 2N5038 and 2N5039.

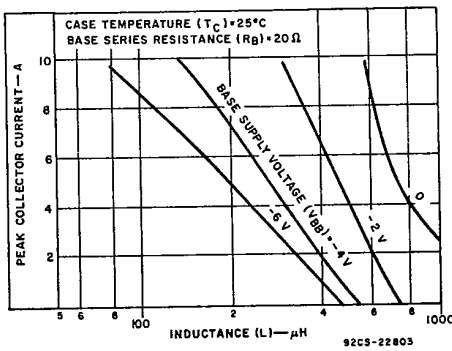

Fig. 7 - Maximum reverse-bias, second-breakdown characteristics for 2N6496.

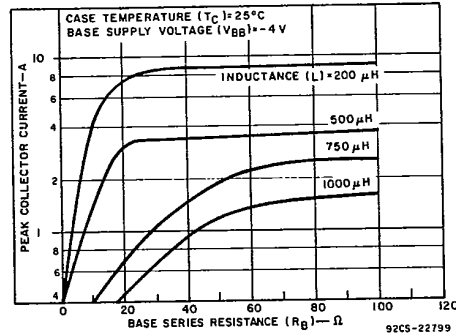

Fig. 8 - Maximum reverse-bias, second-breakdown characteristics for 2N6496.

2N5038, 2N5039, 2N6496

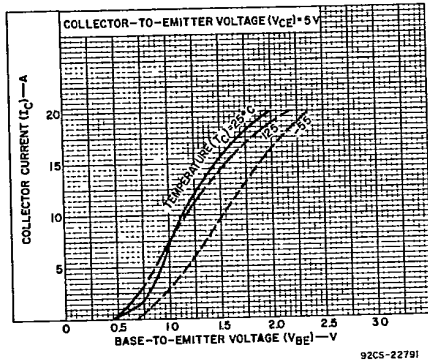

Fig. 9 - Typical transfer characteristics for 2N5038.

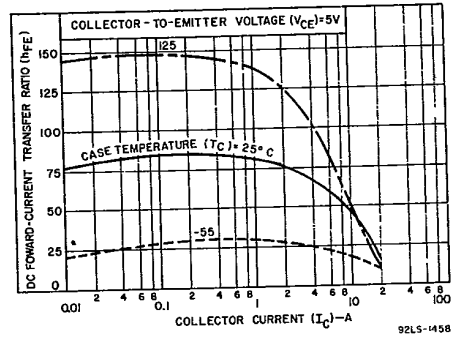

Fig. 10 - Typical dc beta characteristics for 2N5038.

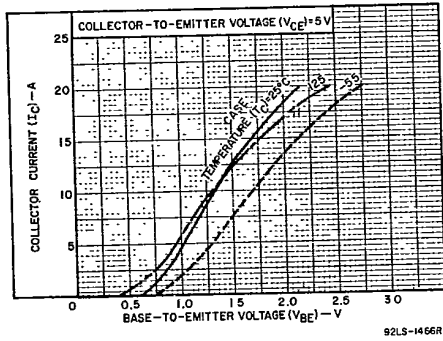

Fig. 11 - Typical transfer characteristics for 2N5039.

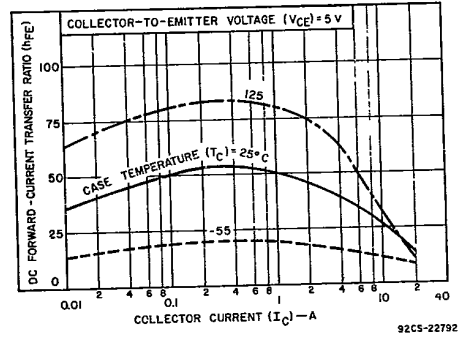

Fig. 12 - Typical dc beta characteristics for 2N5039.

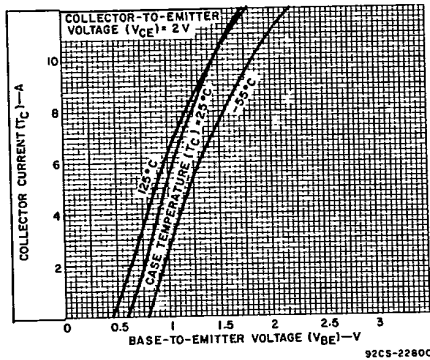

Fig. 13 - Typical transfer characteristics for 2N6496.

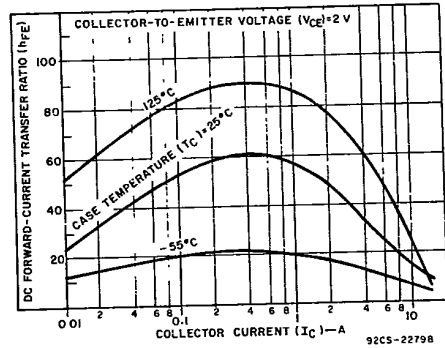

Fig. 14 - Typical dc beta characteristics for 2N6496.

2N5038, 2N5039, 2N6496

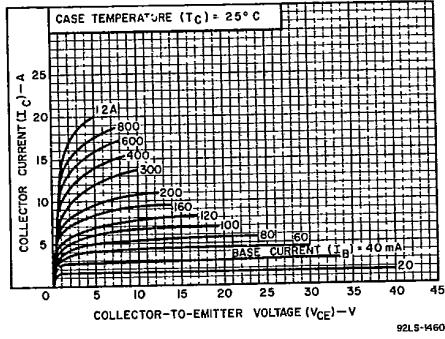

Fig. 15 - Typical output characteristics for 2N5038.

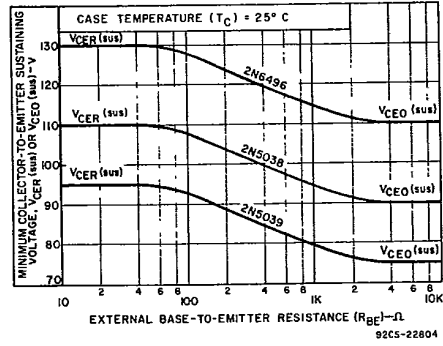

Fig. 16 - Collector-to-emitter sustaining voltage characteristic for all types.

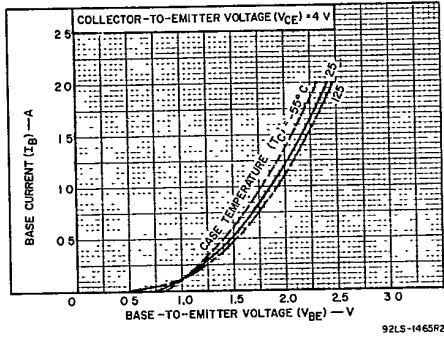

Fig. 17 - Typical output characteristics for 2N5039.

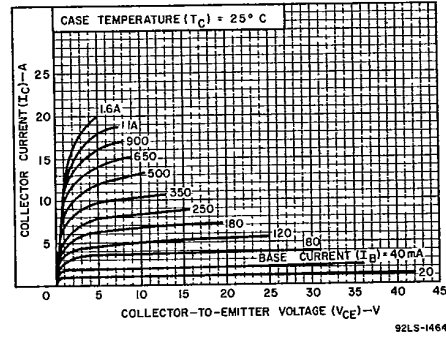

Fig. 18 - Typical input characteristics for 2N5038 and 2N5039.

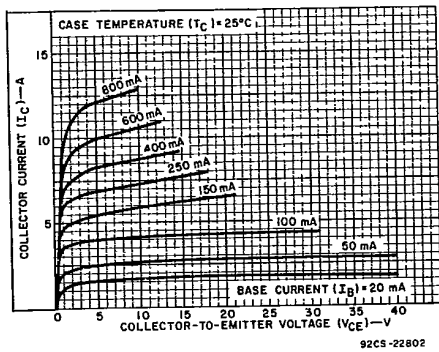

Fig. 19 - Typical output characteristics for 2N6496.

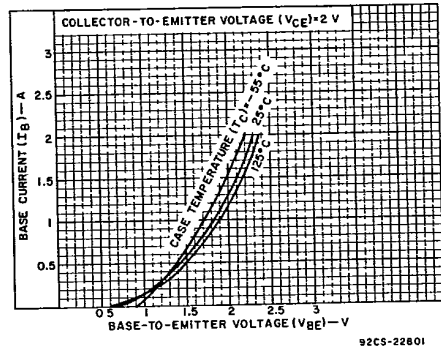

Fig. 20 - Typical input characteristics for 2N6496.

2N5038, 2N5039, 2N6496

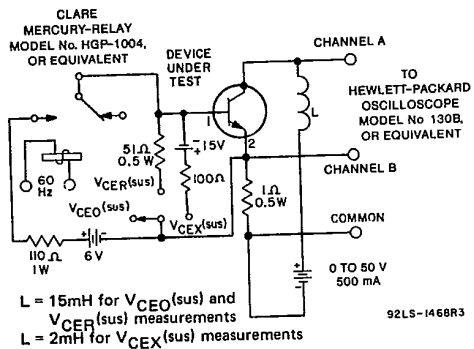
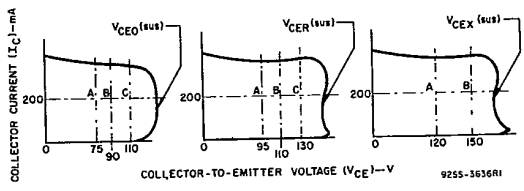

Fig. 21 - Circuit used to measure sustaining voltages $V_{CE0}(sus)$, $V_{CER}(sus)$, and $V_{CEX}(sus)$.



The sustaining voltages ($V_{CE0}(sus)$, $V_{CER}(sus)$, and $V_{CEX}(sus)$) are acceptable when the traces fall to the right of point "A" for type 2N5039, point "B" for type 2N5038 and point "C" for type 2N6496. (NOTE: 2N6496 is not tested for $V_{CEX}(sus)$.)

Fig. 22 - Oscilloscope display for measurement of sustaining voltages (Test circuit shown in Fig. 22).

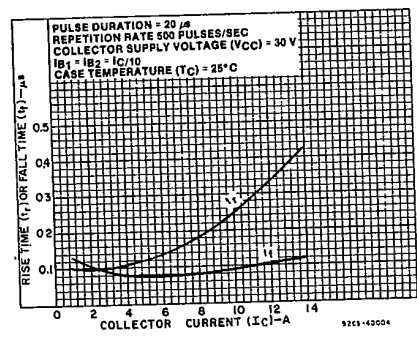

Fig. 23 - Typical rise-time and fall-time characteristics for all types.

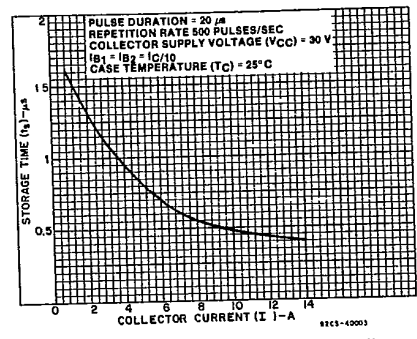

Fig. 24 - Typical storage time characteristic for all types.

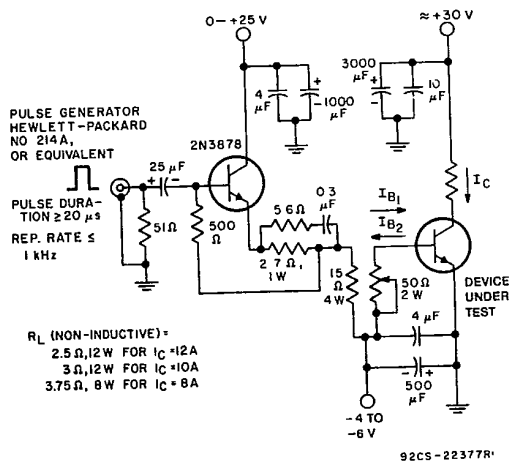

Fig. 25 - Circuit used to measure switching times for all types.

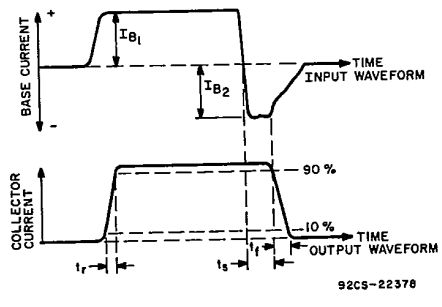

Fig. 26 - Phase relationship between input and output currents showing reference points for specification of switching times. (Test circuit shown in Fig. 26).