

RI23110

CDMA PCS 3–4 Volt Power Amplifier (1720–1910 MHz)

The RI23110 Personal Communications Service (PCS) Power Amplifier is a fully matched 6-pin LCC surface mount module developed for PCS and wireless local loop applications. This small and efficient Power Amplifier packs a full 1720–1910 MHz bandwidth coverage into a single compact package. This device meets the stringent spectral linearity requirements of Code Division Multiple Access (CDMA) PCS transmission, with high power added efficiency for power output of up to 29 dBm. A single GaAs Microwave Monolithic Intergrated Circuit (MMIC) contains all active circuitry in the module. The MMIC contains on-board bias circuitry, as well as input and interstage matching circuits. The output match is realized off-chip within the module package to optimize efficiency and power performance into a 50 Ω load. This device is manufactured with Skyworks' GaAs HBT process that provides for all positive voltage DC supply operation while maintaining high efficiency and good linearity. Primary bias to the RI23110 is supplied directly from a three-cell nickel cadmium, single-cell lithium ion, or other suitable battery with output in the 3–4 volt range. Power down is accomplished by setting the voltage on the low current reference pin to zero volts. No external supply side switch is needed as typical "off" leakage is a few microamperes with full primary voltage supplied from the battery.

Distinguishing Features

- Low voltage positive bias supply
- Good linearity
- High efficiency
- Large dynamic range
- 6-pin LCC package (6 x 6 x 1.5 mm)
- Power down control

Applications

- Personal communications services
- Wireless local loop

Functional Block Diagram

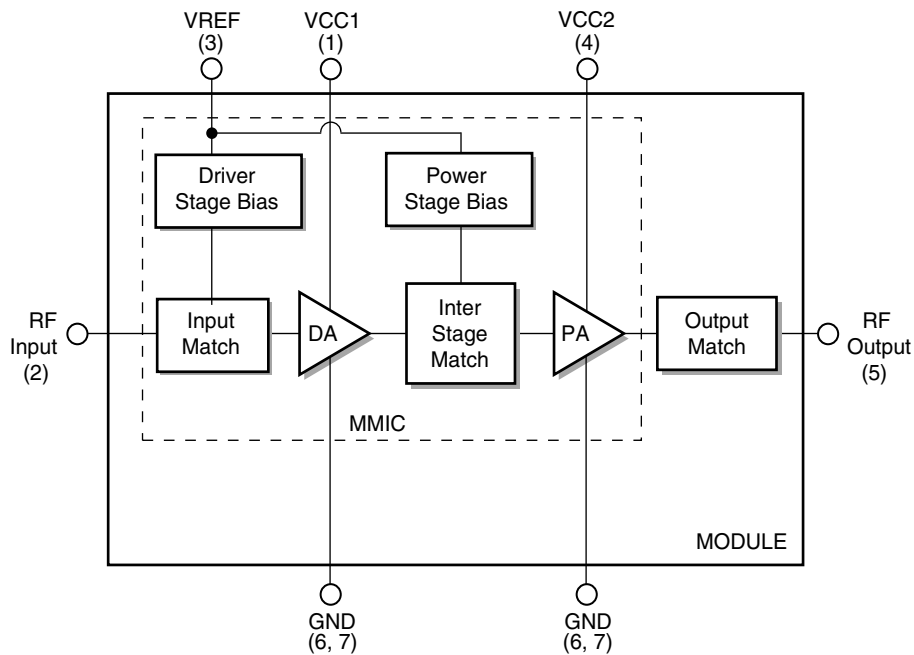

Electrical Specifications

The following tables list the electrical characteristics of the RI23110 Power Amplifier. Table 1 establishes the Absolute Maximum Ratings for continuous operation.

Table 1. Absolute Maximum Ratings⁽¹⁾

Parameter	Symbol	Min	Nominal	Max	Unit
RF Input Power	Pin	—	4.0	7.0	dBm
Supply Voltage	Vcc	—	3.4	6.0	Volts
Reference Voltage	Vref	—	3.0	3.3	Volts
Case Operating Temperature	Tc	–30	+25	+110	°C
Storage Temperature	Tstg	–55	—	+125	°C

NOTE(S):
⁽¹⁾ No damage assuming only one parameter is set at limit at a time with all other parameters set at or below nominal value.

Korean PCS Operation

For Korean PCS operation, Table 2 defines the Recommended Operating Conditions to achieve the electrical performances shown in Tables 3 and 4.

Table 2. Recommended Operating Conditions for Korean PCS Operation

Parameter	Symbol	Min	Nominal	Max	Unit
Supply Voltage	Vcc	3.2	3.4	4.2	Volts
Reference Voltage	Vref	2.95	3.0	3.2	Volts
Operating Frequency	Fo	1720	1750	1780	MHz
Operating Temperature	Tc	–30	+25	+85	°C

Table 3 lists the electrical performance characteristics of the RI23110 Power Amplifier for Nominal Operating Conditions.

Table 3. Electrical Specification for Korean PCS Nominal Operating Conditions⁽¹⁾

Characteristic	Condition	Symbol	Minimum	Typical	Maximum	Unit
Quiescent Current	Nominal	Iq	65.0	70.0	75.0	mA
Gain	Po = 0 dBm	G	23.0	24.0	26.0	dB
	Po = 28 dBm	Gp	25.0	27.5	30.0	dB
Power Added Efficiency	Po = 28 dBm	PAE	26.5	28.0	—	%
Adjacent Channel Power Ratio	Po ≤ 28 dBm ⁽²⁾	ACP	—	–54.0	–50.0	dBc
	Po ≤ 29 dBm ⁽²⁾	ACP	—	–51.0	–49.5	dBc

Table 3. Electrical Specification for Korean PCS Nominal Operating Conditions⁽¹⁾

Characteristic	Condition	Symbol	Minimum	Typical	Maximum	Unit
Harmonic Suppression Second Third	Po ≤ 28 dBm	DFo2	—	-55.0	-50.0	dBc
	Po ≤ 28 dBm	DFo3	—	-52.0	-49.0	dBc
Noise Power in RX Band 1720–1780 MHz	Po ≤ 28 dBm	RxBN	—	-132.0	-131.0	dBm/Hz
Noise Figure	—	NF	—	3.0	4.0	dB
Input Voltage Standing Wave Ratio	—	VSWR	—	1.4:1	2.0:1	
Stability (spurious output)	5:1 VSWR All Phases	S	—	—	-60.0	dBc
Ruggedness – no damage	Po ≤ 28 dBm	Ru	10:1	—	—	VSWR

NOTE(S):
⁽¹⁾ Vcc=+3.4V, Vref=+3.0 V, Freq. = 1750 MHz, Tc=25 °C, unless otherwise specified.
⁽²⁾ ACPR is specified per IS95 as the ratio of the total in-band power (1.23 MHz BW) to adjacent power in a 30 kHz BW

Table 4 specifies the performance limits beyond the Recommended Operating Conditions, including part-to-part variability.

Table 4. Electrical Specifications Limits for Korean PCS Recommended Operating Conditions⁽¹⁾

Characteristic	Condition	Symbol	Minimum	Maximum	Unit
Quiescent Current	Nominal	Iq	—	110.0	mA
Gain	Po = 0 dBm	G	21.7	26.4	dB
	Po = 28 dBm	Gp	22.5	31.5	dB
Power Added Efficiency	Po = 28 dBm	PAE	24.0	—	%
Adjacent Channel Power Ratio	Po ≤ 28 dBm ⁽²⁾	ACP	—	-44.0	dBc
Harmonic Suppression Second Third	Po ≤ 28 dBm	DFo2	—	-40.0	dBc
	Po ≤ 28 dBm	DFo3	—	-40.0	dBc
Noise Power in Rx Band 1720–1780 MHz	Po = 28 dBm	RxBN	—	-130.0	dBm/Hz
Noise Figure	—	NF	—	6.0	dB
Input Voltage Standing Wave Ratio	—	VSWR	—	1.6:1	
Stability (spurious output)	5:1 VSWR all Phases	S	—	-60.0	dBc
Ruggedness – no damage	Po ≤ 28 dBm	Ru	10:1	—	VSWR

NOTE(S):
⁽¹⁾ Per Table 2
⁽²⁾ ACPR is specified per IS95 as the ratio of the total in-band power (1.23 MHz BW) to adjacent power in a 30 kHz BW

United States PCS Operation

The electrical characteristics of the RI23110 Power Amplifier for United States PCS operation are shown in Tables 5 through 7.

Table 5 lists the operating conditions recommended to achieve the electrical performances shown in Tables 6 and 7.

Table 5. Recommended Operating Conditions for US PCS Operation

Parameter	Symbol	Min.	Nominal	Max	Unit
Supply Voltage	Vcc	3.20	3.40	4.20	Volts
Reference Voltage	Vref	2.95	3.00	3.20	Volts
Operating Frequency	Fo	1850	1880	1910	MHz
Operating Temperature	Tc	-30	+25	+85	°C

Table 6 lists the electrical performance characteristics of the RI23110 Power Amplifier for Nominal Operating Conditions.

Table 6. Electrical Specification for US PCS Nominal Operating Conditions⁽¹⁾

Characteristic	Condition	Symbol	Minimum	Typical	Maximum	Unit
Quiescent Current	Nominal	Iq	65.0	70.0	75.0	mA
Gain	Po = 0 dBm	G	22.5	24.5	26.0	dB
	Po = 28 dBm	Gp	23.5	26.5	29.0	dB
Power Added Efficiency	Po = 28 dBm	PAE	30.0	31.5	—	%
Adjacent Channel Power Ratio	Po ≤ 28 dBm ⁽²⁾	ACP	—	-51.0	-48.0	dBc
	Po ≤ 29 dBm ⁽²⁾	ACP	—	-47.0	—	dBc
Harmonic Suppression	Po ≤ 28 dBm	DFo2	—	-46.0	-43.0	dBc
	Po ≤ 28 dBm	DFo3	—	-41.0	-38.0	dBc
Noise Power in RX Band 1930–1990 MHz	Po ≤ 28 dBm	RxBN	-136.0	-134.0	-133.0	dBm/Hz
Noise Figure	—	NF	—	3.6	4.0	dB
Input Voltage Standing Wave Ratio	—	VSWR	—	1.5:1	2.0:1	
Stability (spurious output)	5:1 VSWR All Phases	S	—	—	-60.0	dBc
Ruggedness – no damage	Po ≤ 28 dBm	Ru	10:1	—	—	VSWR

NOTE(S):
⁽¹⁾ Vcc=+3.4V, Vref=+3.0 V, Freq. = 1880 MHz, Tc=25 °C, unless otherwise specified.
⁽²⁾ ACPR is specified per IS95 as the ratio of the total in-band power (1.23 MHz BW) to adjacent power in a 30 kHz BW

Table 7 specifies the performance limits beyond the Recommended Operating Conditions, including part-to-part variability.

Table 7. Electrical Specifications Limits for US PCS Recommended Operating Conditions⁽¹⁾

Characteristic	Condition	Symbol	Minimum	Maximum	Unit
Quiescent Current	Nominal	I _q	—	110.0	mA
Gain	P _o = 0 dBm	G	21.0	27.0	dB
	P _o = 28 dBm	G _p	21.0	31.0	dB
Power Added Efficiency	P _o = 28 dBm	PAE	29.5	—	%
Adjacent Channel Power Ratio	P _o ≤ 28 dBm ⁽²⁾	ACP	—	–43.0	dBc
Harmonic Suppression	P _o ≤ 28 dBm	Second	—	–35.0	dBc
		Third	—	–35.0	dBc
Noise Power in RX Band 1930–1990 MHz	P _o = 28 dBm	RxBN	—	–130.0	dBm/Hz
Noise Figure	—	NF	—	6.0	dB
Input Voltage Standing Wave Ratio	—	VSWR	—	3.0:1	
Stability (spurious output)	5:1 VSWR All Phases	S	—	–60.0	dBc
Ruggedness – no damage	P _o ≤ 28 dBm	Ru	10:1	—	VSWR
NOTE(S):					
⁽¹⁾ Per Table 5.					
⁽²⁾ ACPR is specified per IS95 as the ratio of the total in-band power (1.23 MHz BW) to adjacent power in a 30 kHz BW					

Characterization Data

This section contains two complete sets of performance graphs. One set describes operation in the Korean PCS band and the other set describes US PCS operation.

Korean PCS Band (1720–1780 MHz)

The following graphs illustrate the characteristics of a typical RI23110 power amplifier selected for operation in the Korean PCS band. This amplifier was selected by characterizing a group of devices and selecting a part with average electrical performance at both nominal and worst case (limit) conditions. Figures 1 through 9 illustrate the digital signal characteristics of the RI23110 in the Korean PCS band.

Figure 1. Digital Gain vs. Output Power

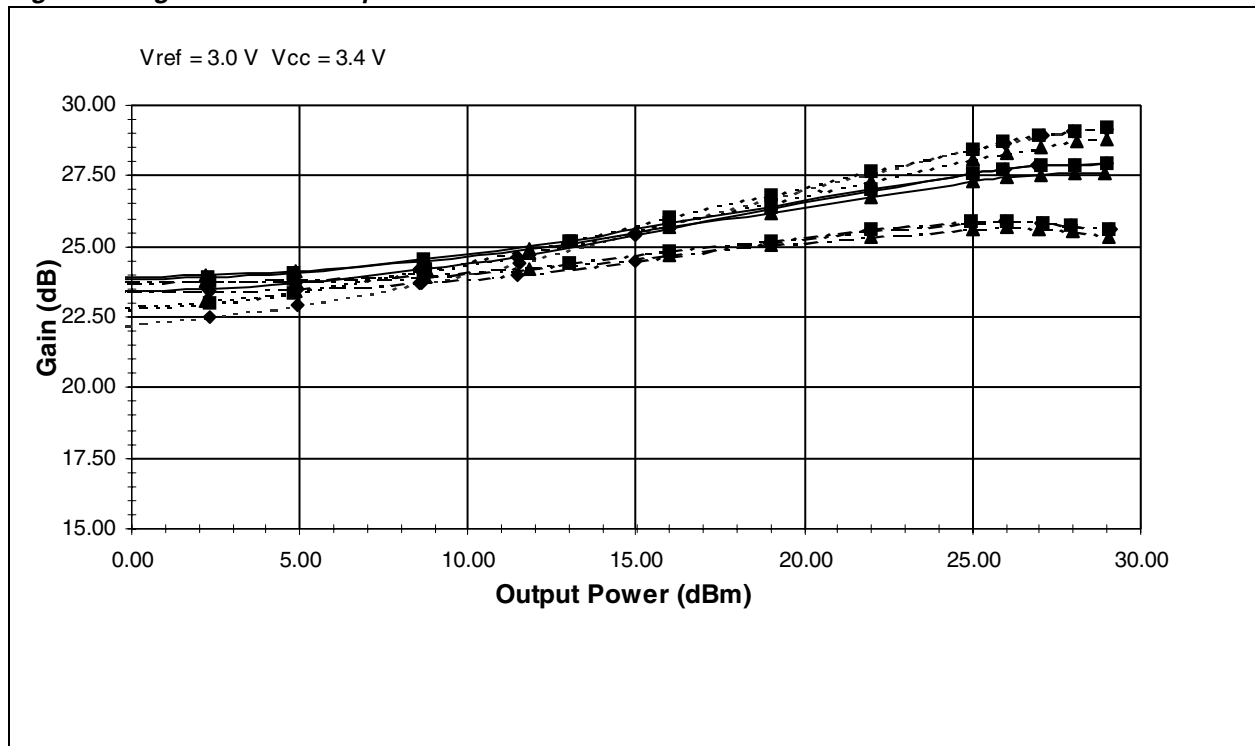

Legend

---◆---	1720 MHz @ -30 °C	—◆—	1720 MHz @ +25 °C	---◆---	1720 MHz @ +85 °C
---■---	1750 MHz @ -30 °C	—■—	1750 MHz @ +25 °C	---■---	1750 MHz @ +85 °C
---▲---	1780 MHz @ -30 °C	—▲—	1780 MHz @ +25 °C	---▲---	1780 MHz @ +85 °C

Figure 2. Adjacent Channel Power Ratio Magnitude (ACP) vs. Output Power

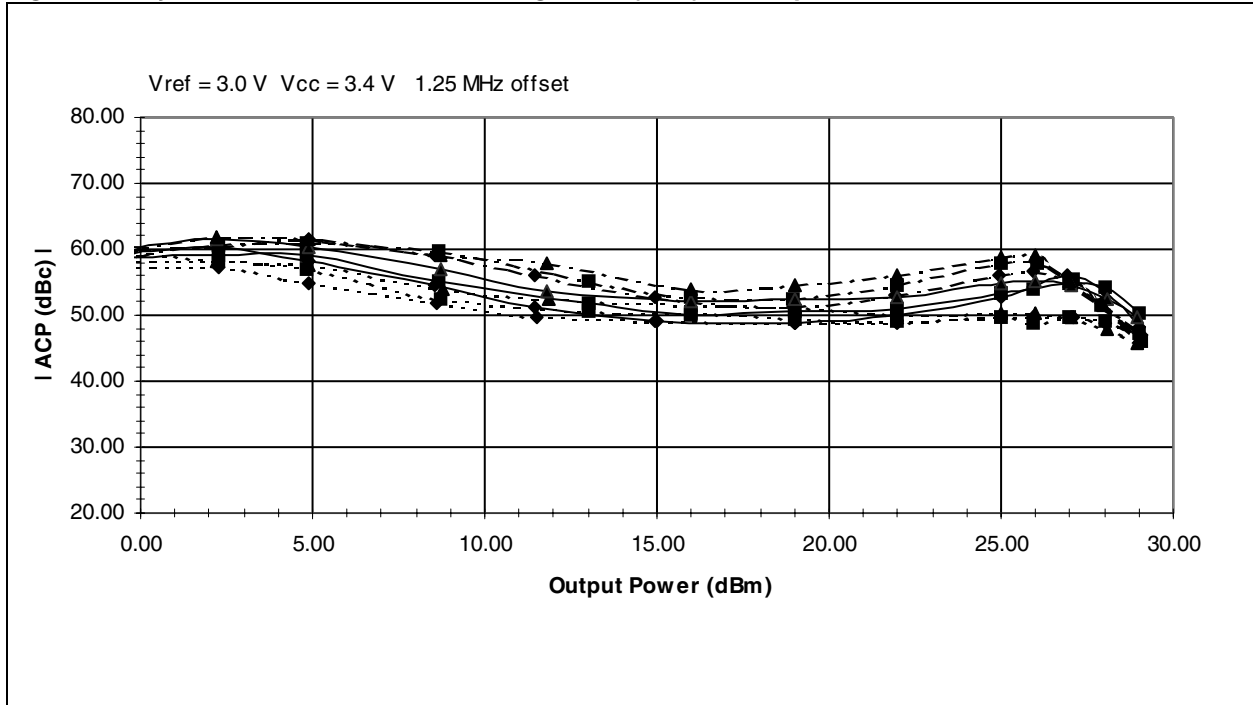
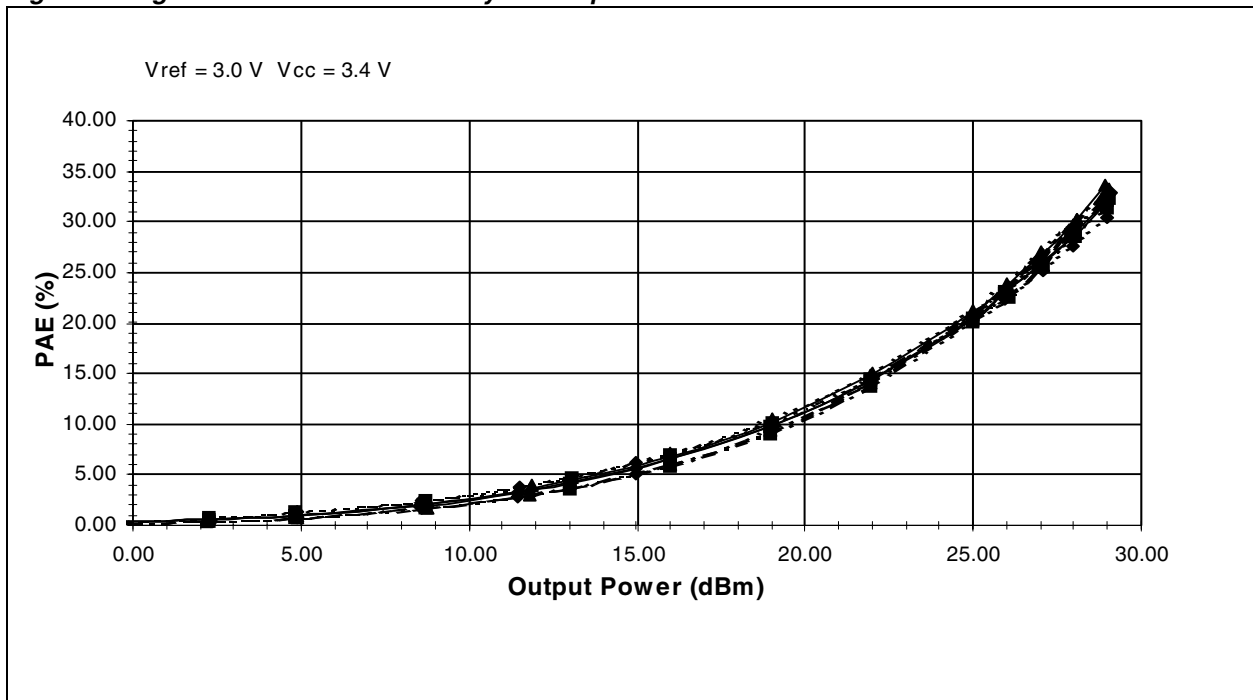

Figure 3. Digital Power Added Efficiency vs. Output Power



Legend

---◆---	1720 MHz @ -30 °C	---◆---	1720 MHz @ +25 °C	---◆---	1720 MHz @ +85 °C
---■---	1750 MHz @ -30 °C	---■---	1750 MHz @ +25 °C	---■---	1750 MHz @ +85 °C
---▲---	1780 MHz @ -30 °C	---▲---	1780 MHz @ +25 °C	---▲---	1780 MHz @ +85 °C

Figure 4. Digital Second Order Harmonic Suppression Magnitude vs. Output Power

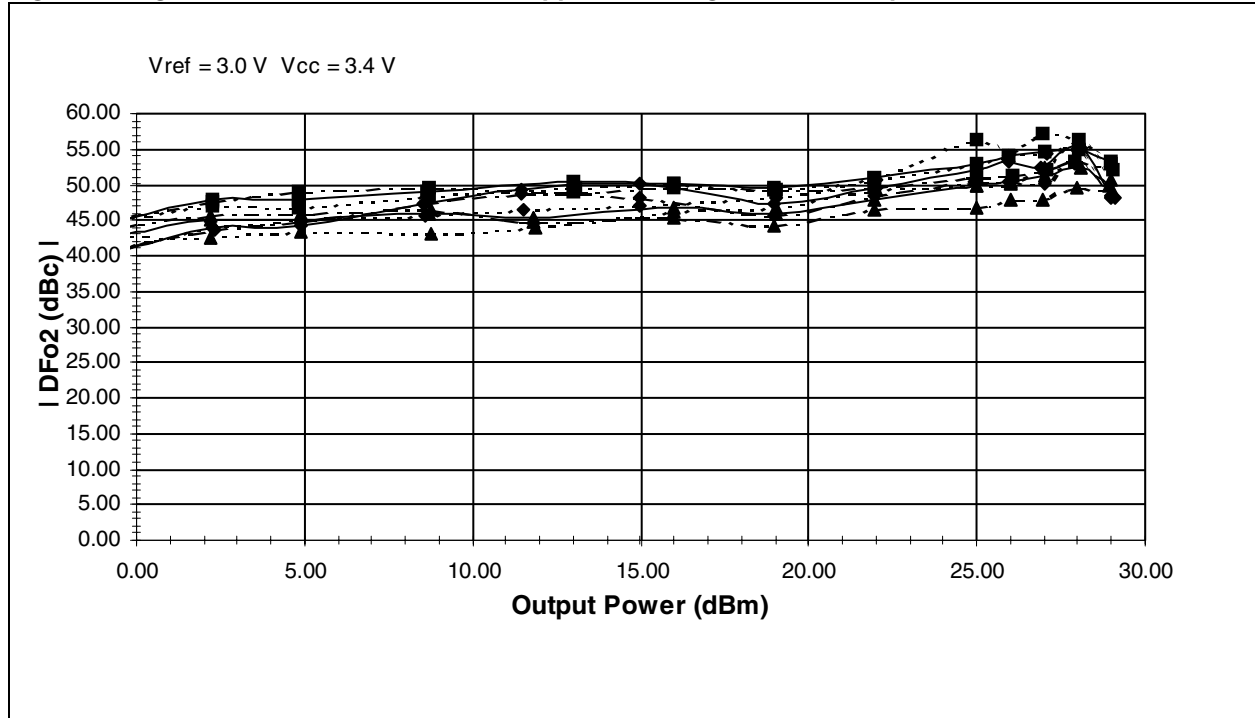
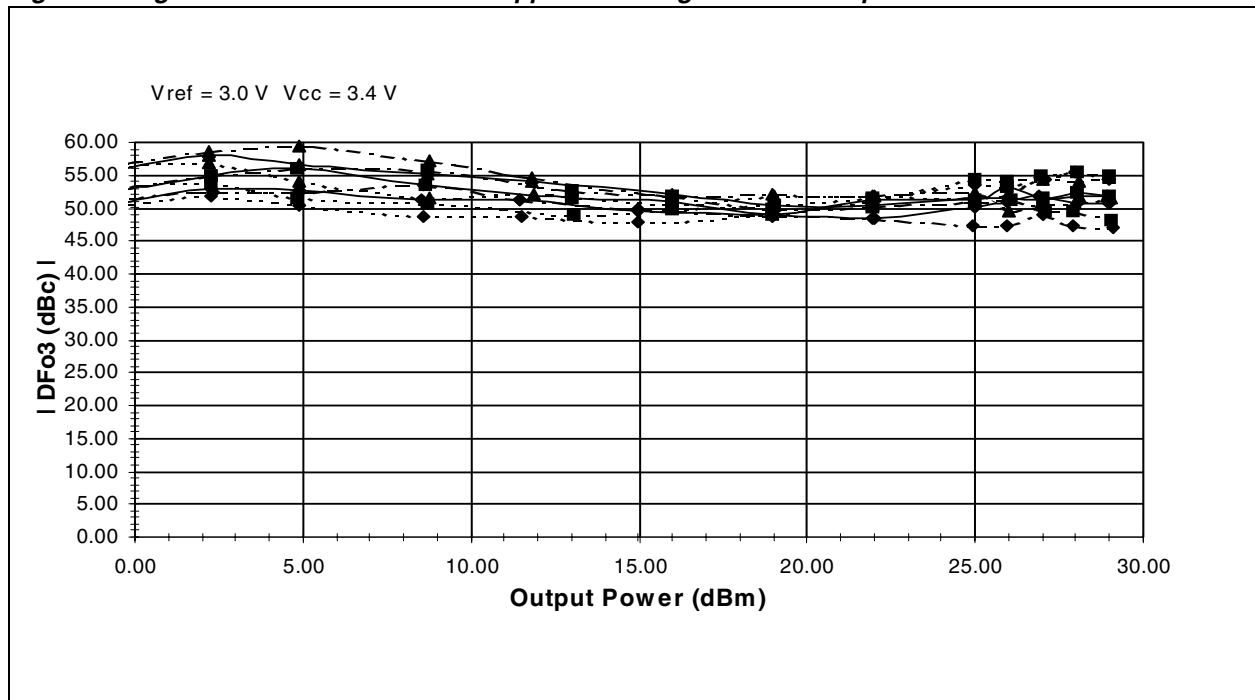

Figure 5. Digital Third Order Harmonic Suppression Magnitude vs. Output Power



Legend

---◆---	1720 MHz @ -30 °C	—◆—	1720 MHz @ +25 °C	---◆---	1720 MHz @ +85 °C
---■---	1750 MHz @ -30 °C	—■—	1750 MHz @ +25 °C	---■---	1750 MHz @ +85 °C
---▲---	1780 MHz @ -30 °C	—▲—	1780 MHz @ +25 °C	---▲---	1780 MHz @ +85 °C

Figure 6. Gain Variation Over Recommended Operating Conditions for 28 dBm Output Power

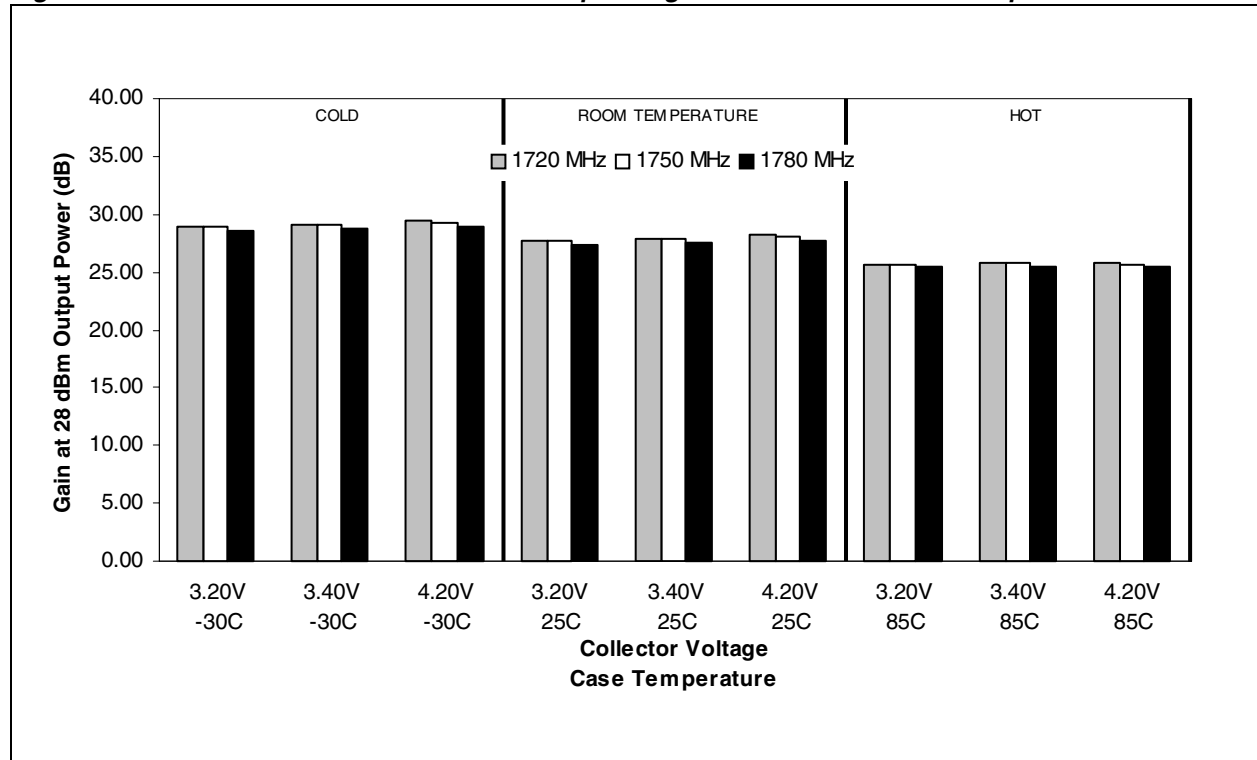

Figure 7. Adjacent Channel Power Ratio Magnitude Variation Over Recommended Operating Conditions for 28 dBm Output Power

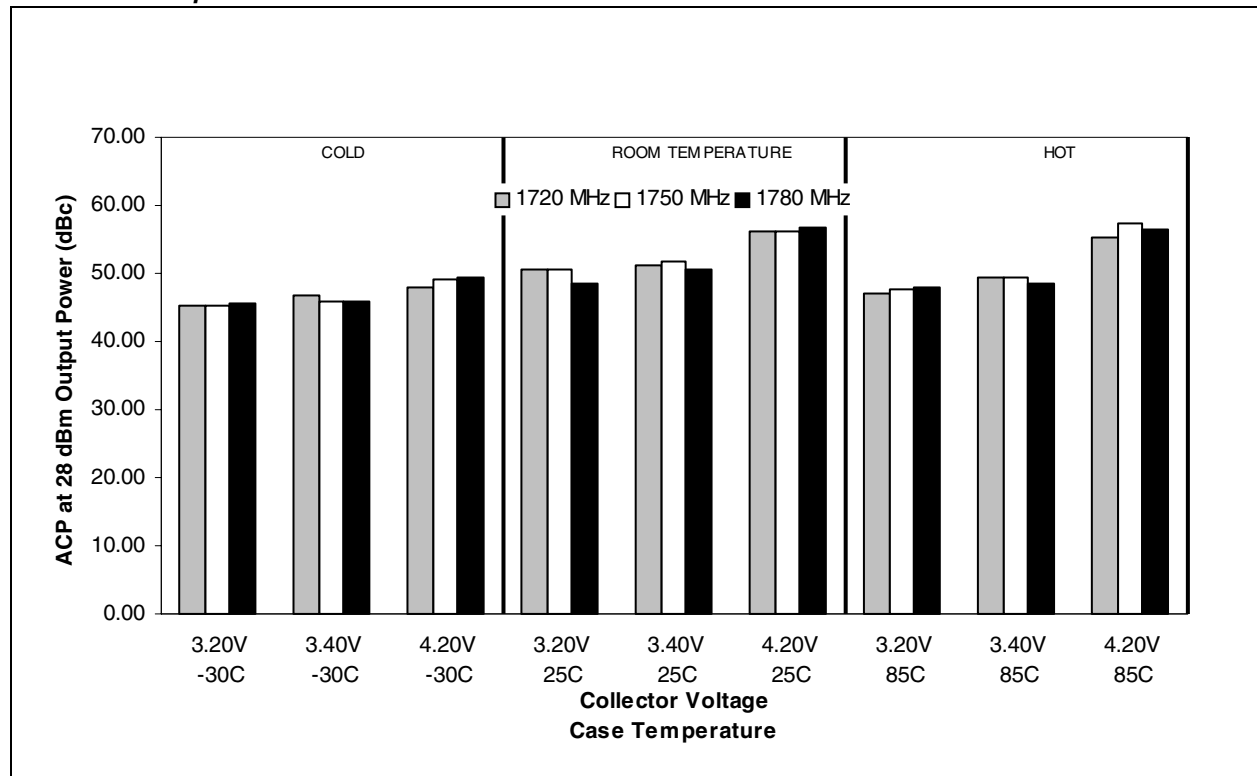

Figure 8. Noise Figure Variation Over Recommended Operating Conditions

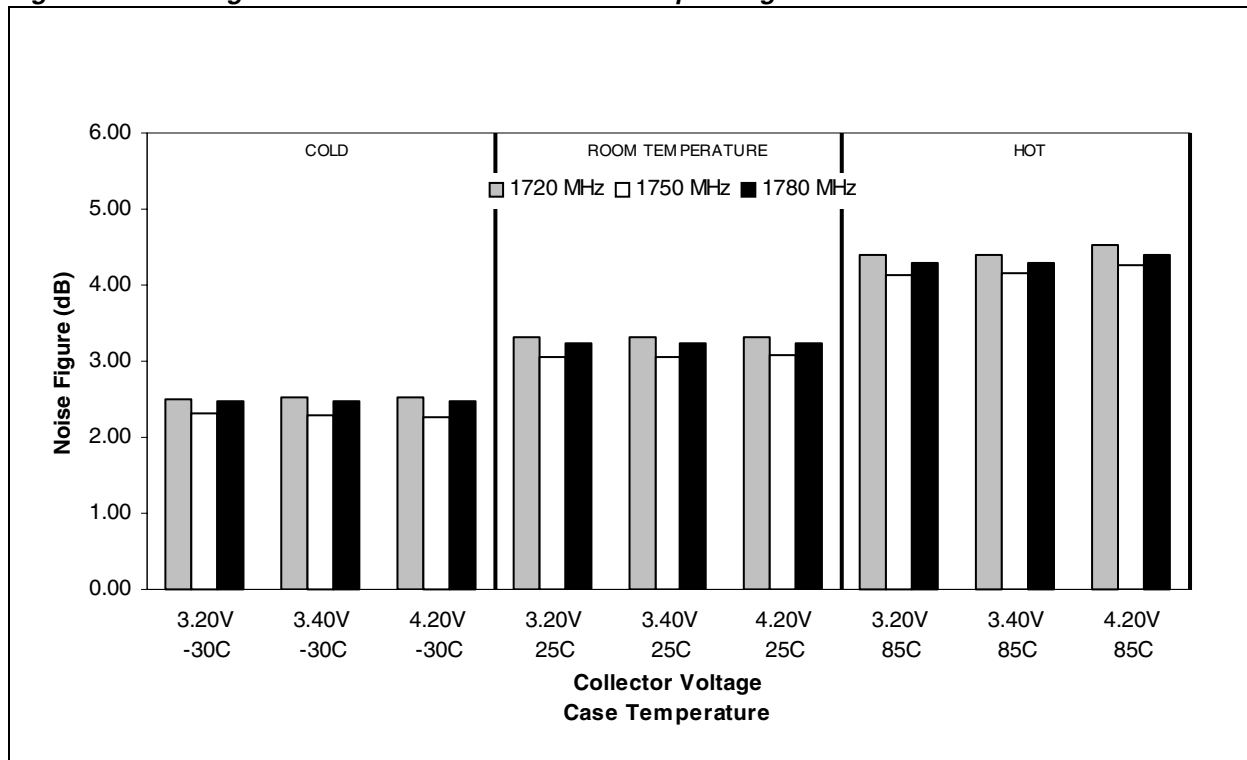
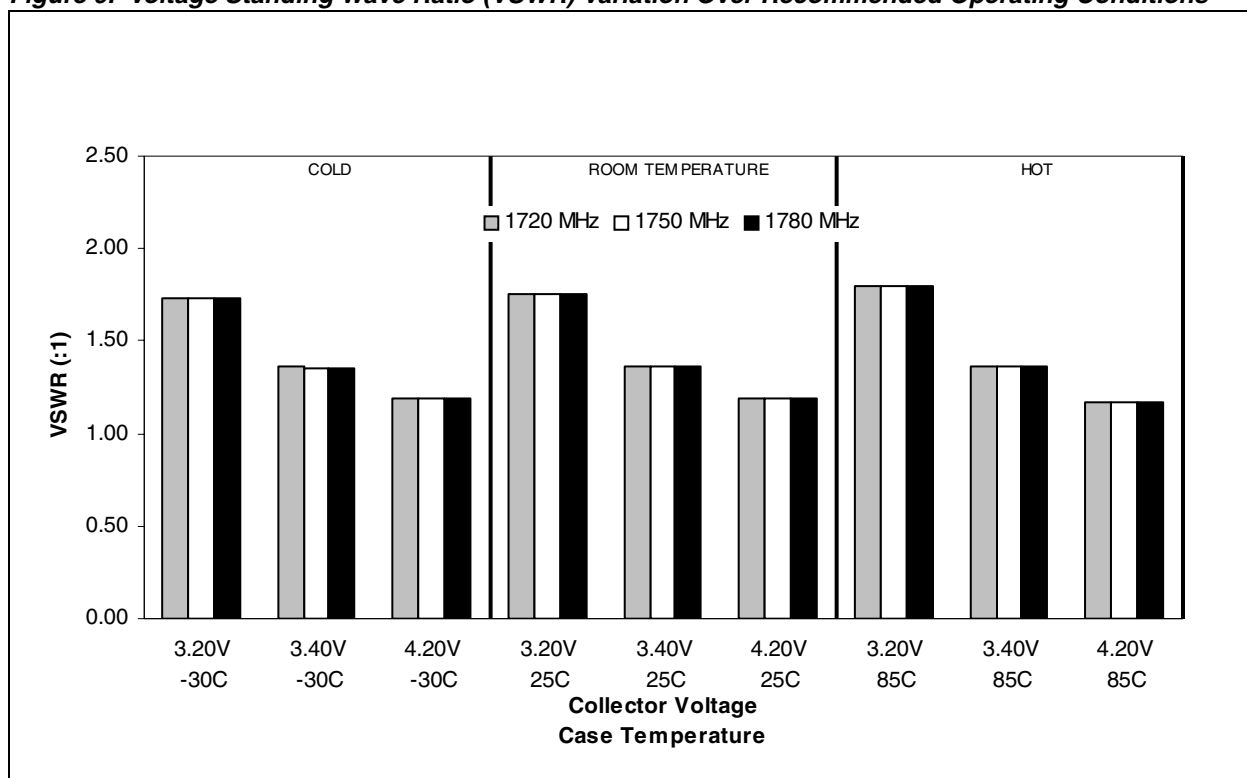

Figure 9. Voltage Standing Wave Ratio (VSWR) Variation Over Recommended Operating Conditions



United States PCS Band (1850-1910 MHz)

The following graphics illustrate the characteristics of a typical RI23110 power amplifier selected for operation in the U.S. PCS band.

This amplifier was selected by characterizing a group of devices, and selecting a part having average electrical performance both at nominal and worst case conditions. Figures 10 through 18 illustrate the digital signal characteristics of the RI23110 in the U.S. PCS band.

Figure 10. Digital Gain vs. Output Power

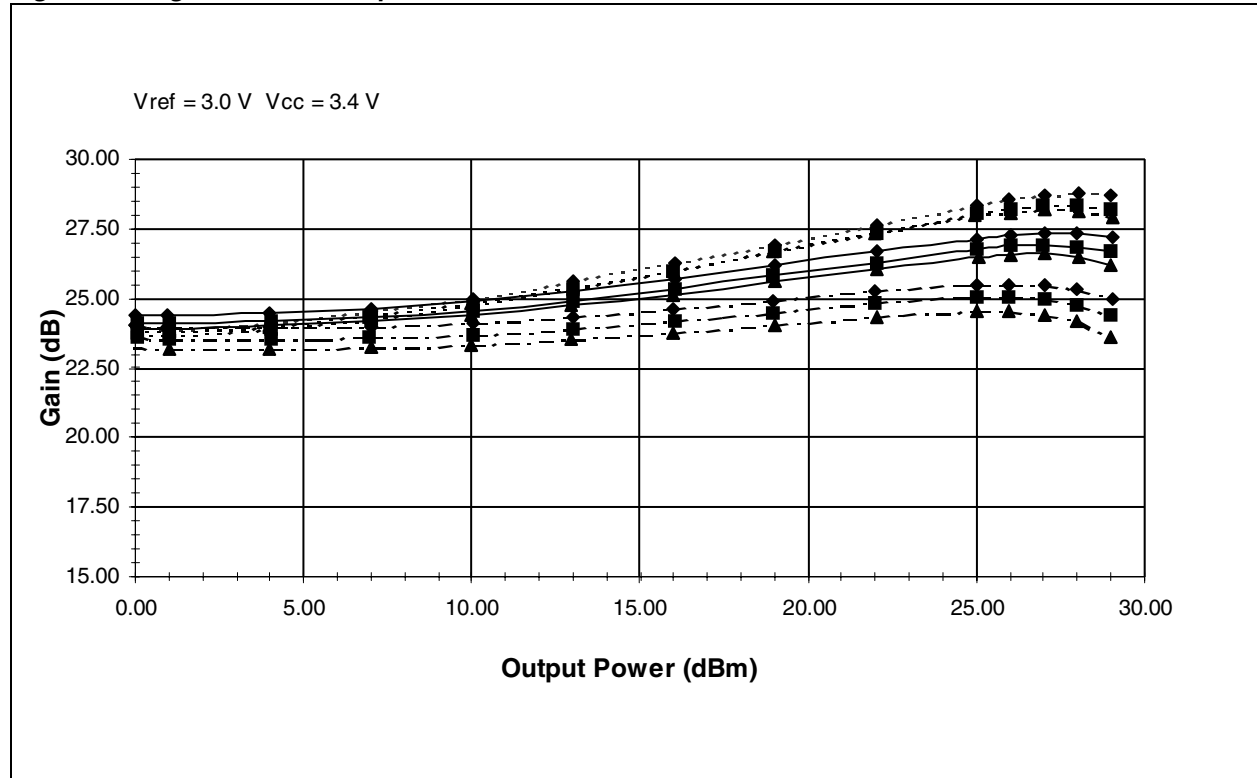

Legend

---◆---	1850 MHz @ -30 °C	—◆—	1850 MHz @ +25 °C	---◆---	1850 MHz @ +85 °C
---■---	1880 MHz @ -30 °C	—■—	1880 MHz @ +25 °C	---■---	1880 MHz @ +85 °C
---▲---	1910 MHz @ -30 °C	—▲—	1910 MHz @ +25 °C	---▲---	1910 MHz @ +85 °C

Figure 11. Adjacent Channel Power Ratio Magnitude (ACP) vs. Output Power

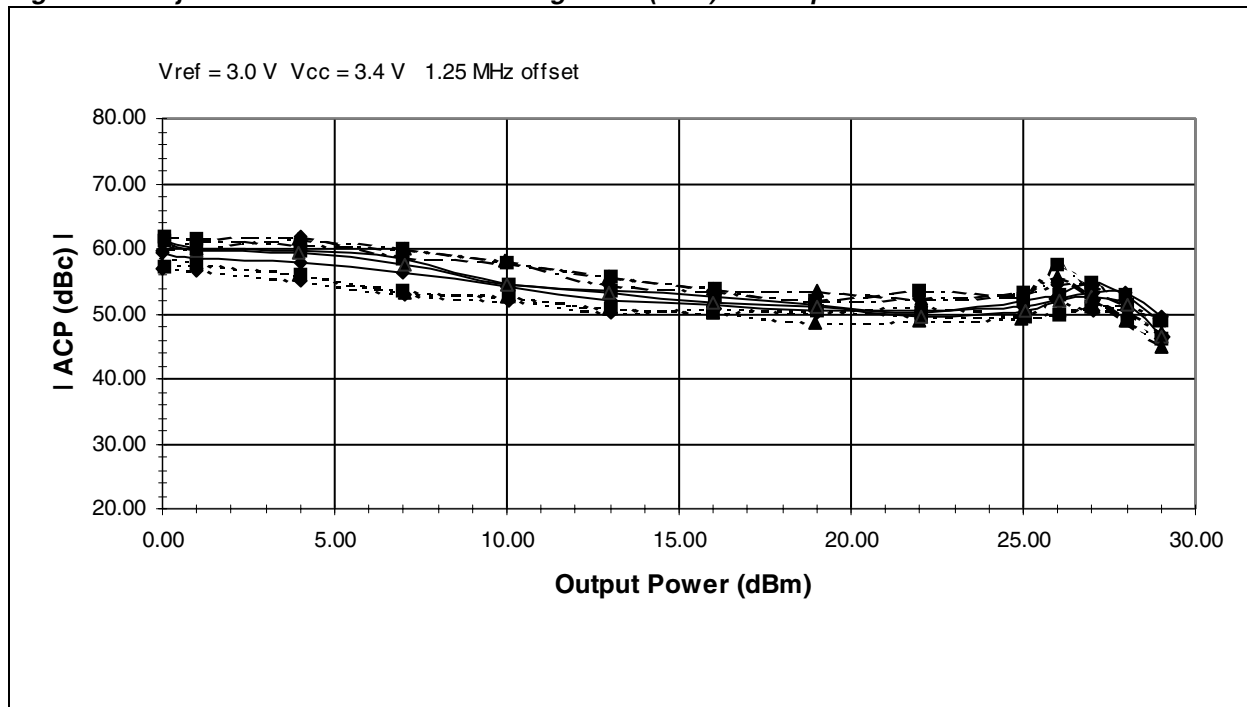
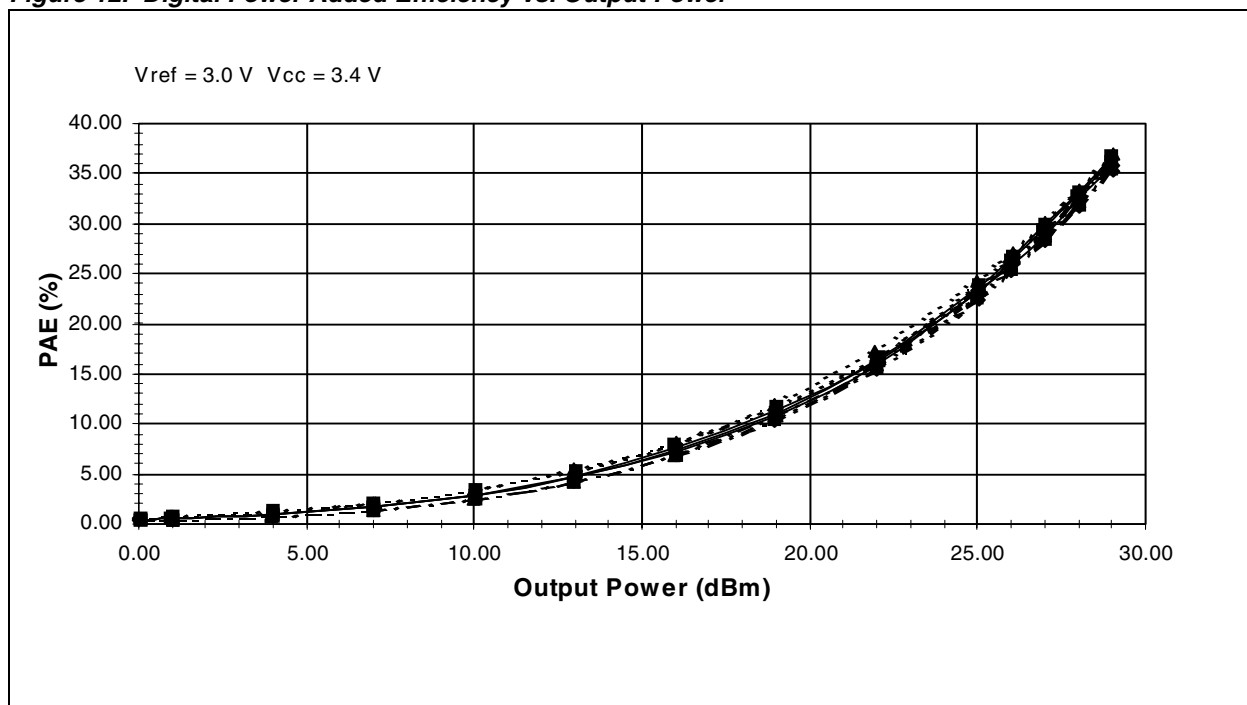

Figure 12. Digital Power Added Efficiency vs. Output Power



Legend

---◆---	1850 MHz @ -30 °C	—◆—	1850 MHz @ +25 °C	---◆---	1850 MHz @ +85 °C
---■---	1880 MHz @ -30 °C	—■—	1880 MHz @ +25 °C	---■---	1880 MHz @ +85 °C
---▲---	1910 MHz @ -30 °C	—▲—	1910 MHz @ +25 °C	---▲---	1910 MHz @ +85 °C

Figure 13. Digital Second Order Harmonic Suppression vs. Output Power

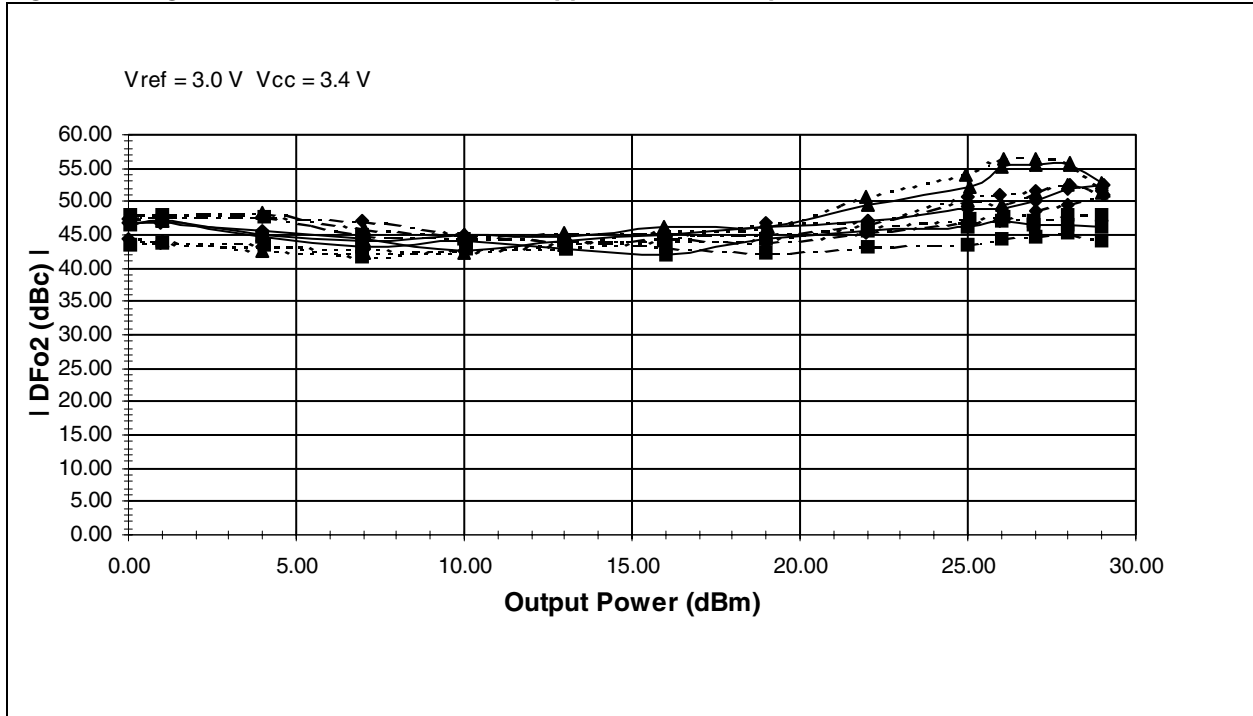
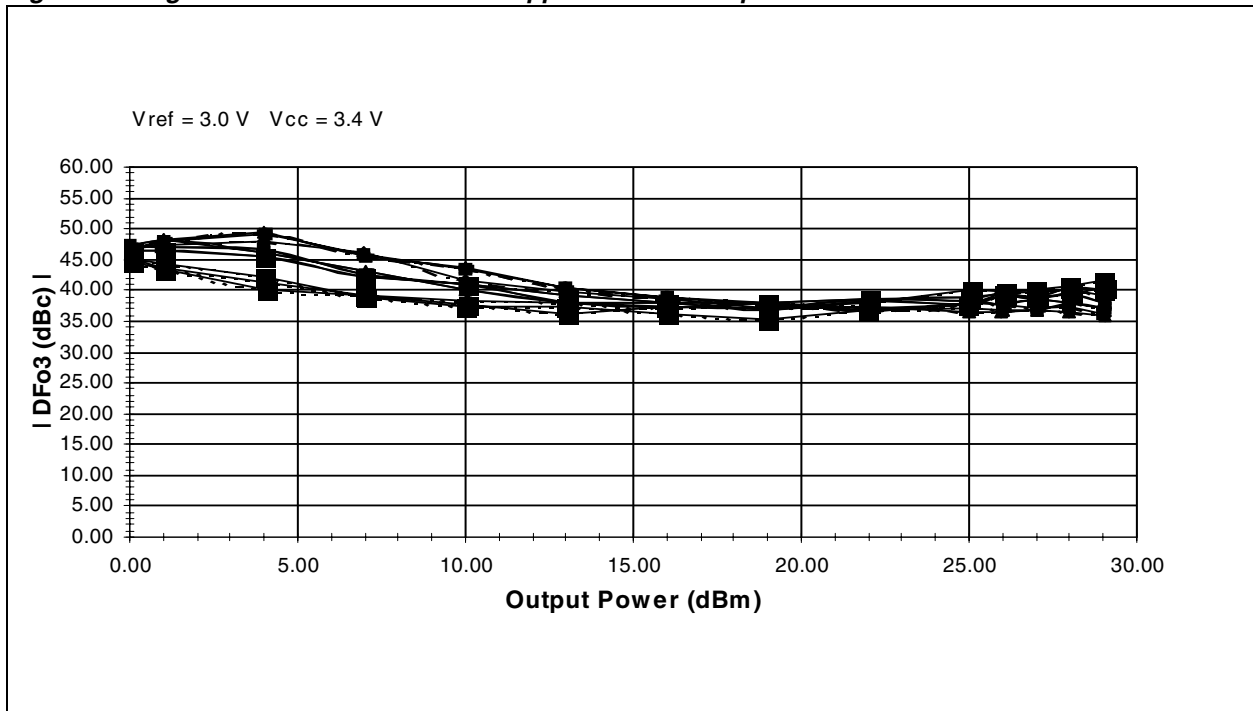

Figure 14. Digital Third Order Harmonic Suppression vs. Output Power



Legend

---◆---	1850 MHz @ -30 °C	---◆---	1850 MHz @ +25 °C	---◆---	1850 MHz @ +85 °C
---■---	1880 MHz @ -30 °C	---■---	1880 MHz @ +25 °C	---■---	1880 MHz @ +85 °C
---▲---	1910 MHz @ -30 °C	---▲---	1910 MHz @ +25 °C	---▲---	1910 MHz @ +85 °C

Figure 15. Gain Variation Over Recommended Operating Conditions for 28 dBm Output Power

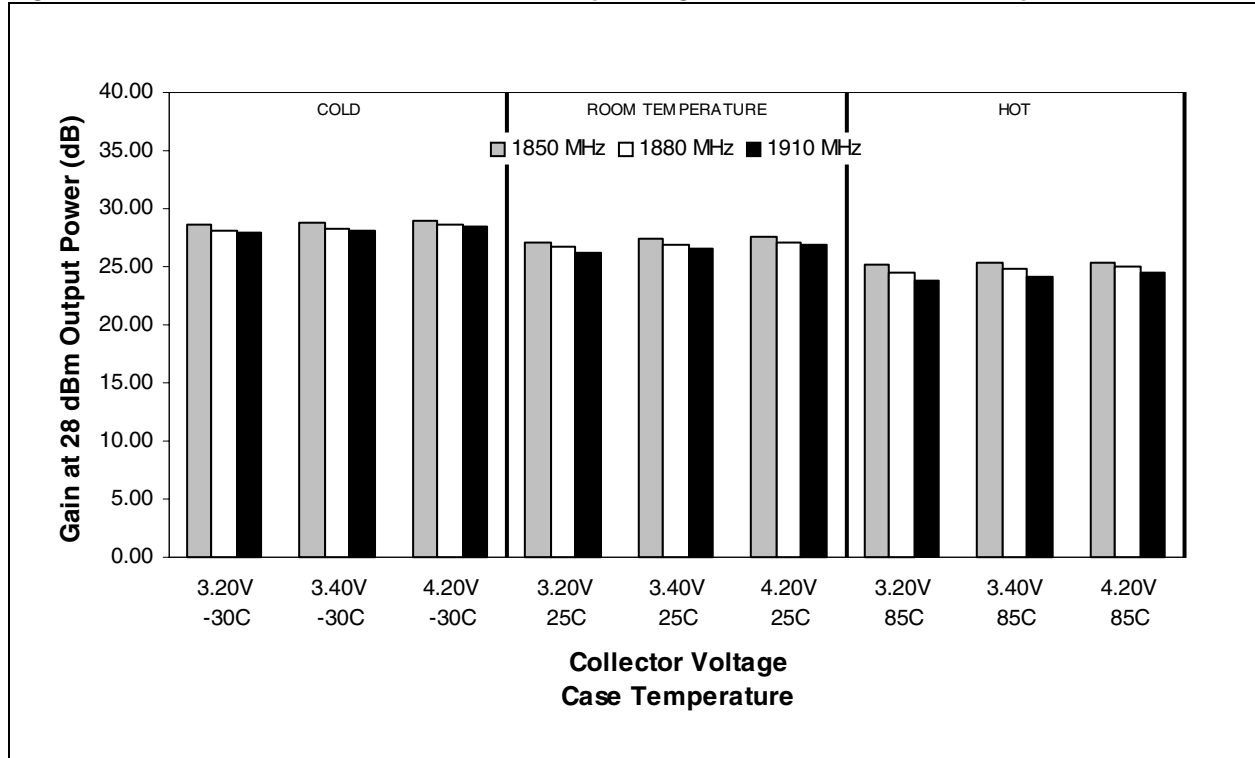

Figure 16. Adjacent Channel Power Ratio Magnitude Variation Over Recommended Operating Conditions for 28 dBm Output Power

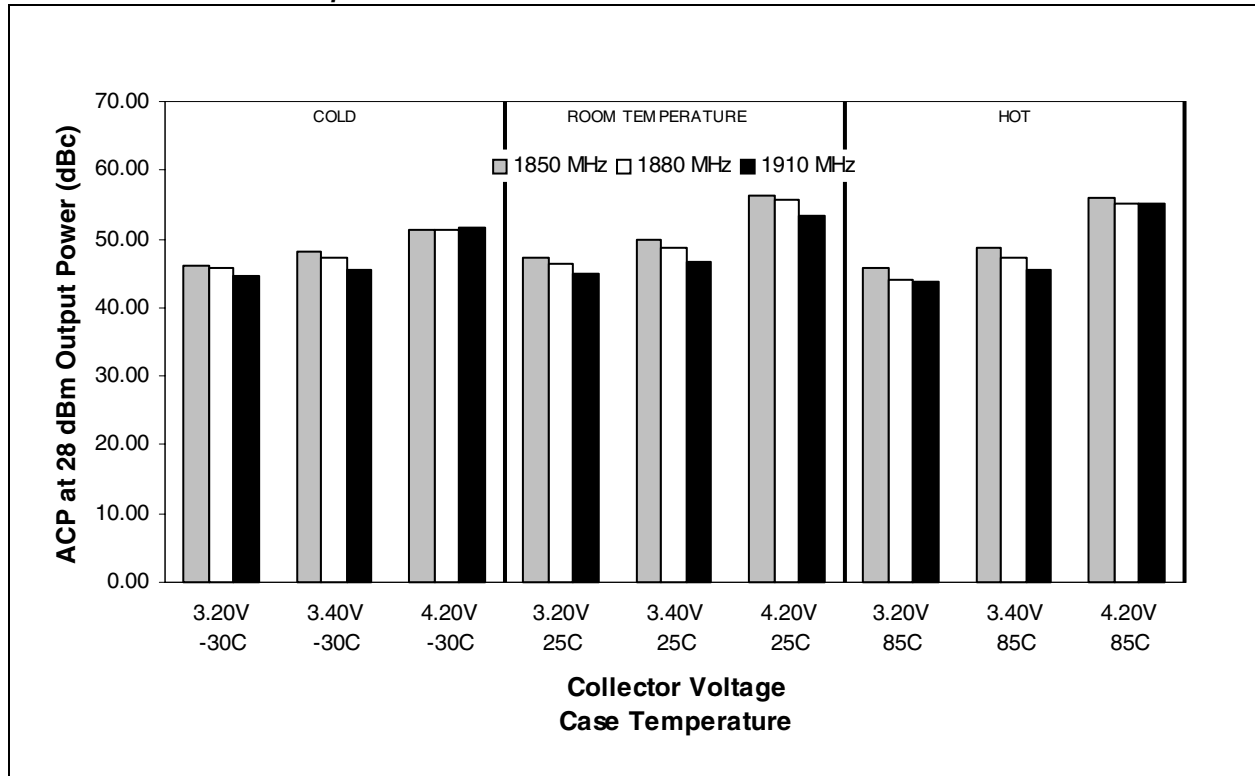

Figure 17. Noise Figure Variation Over Recommended Operating Conditions

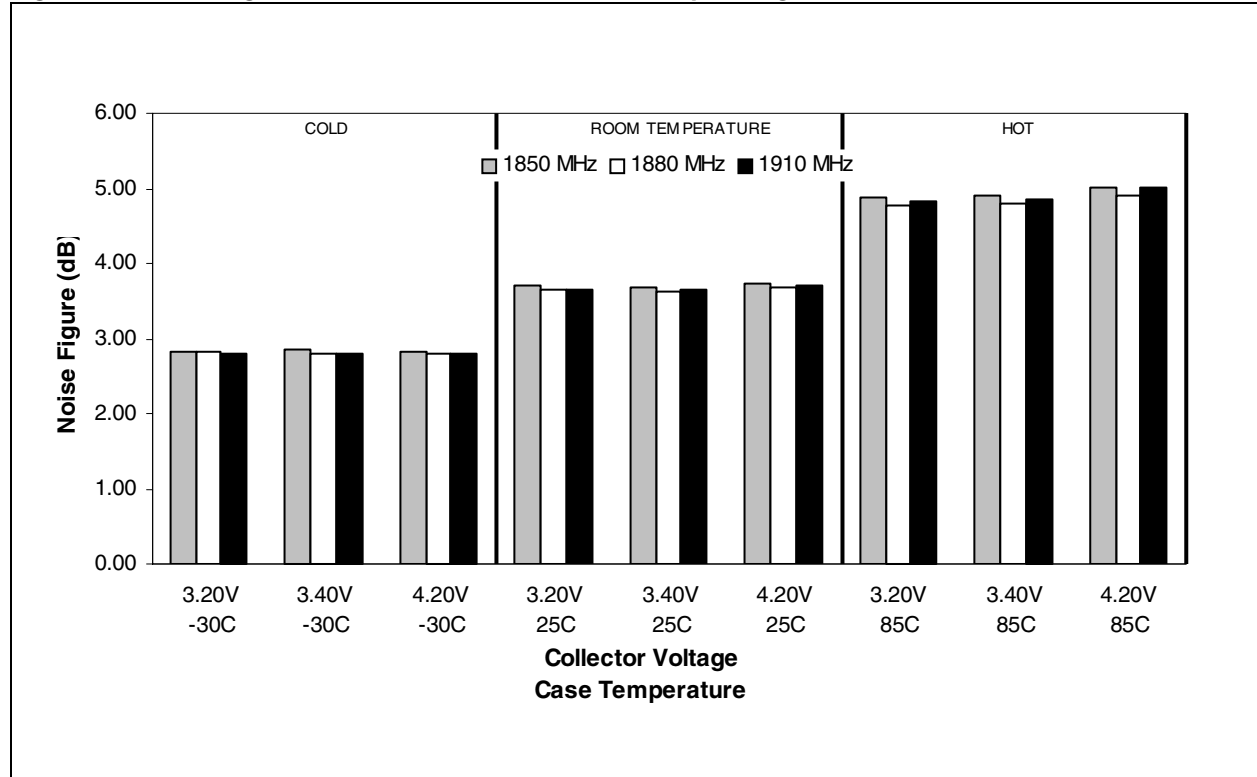
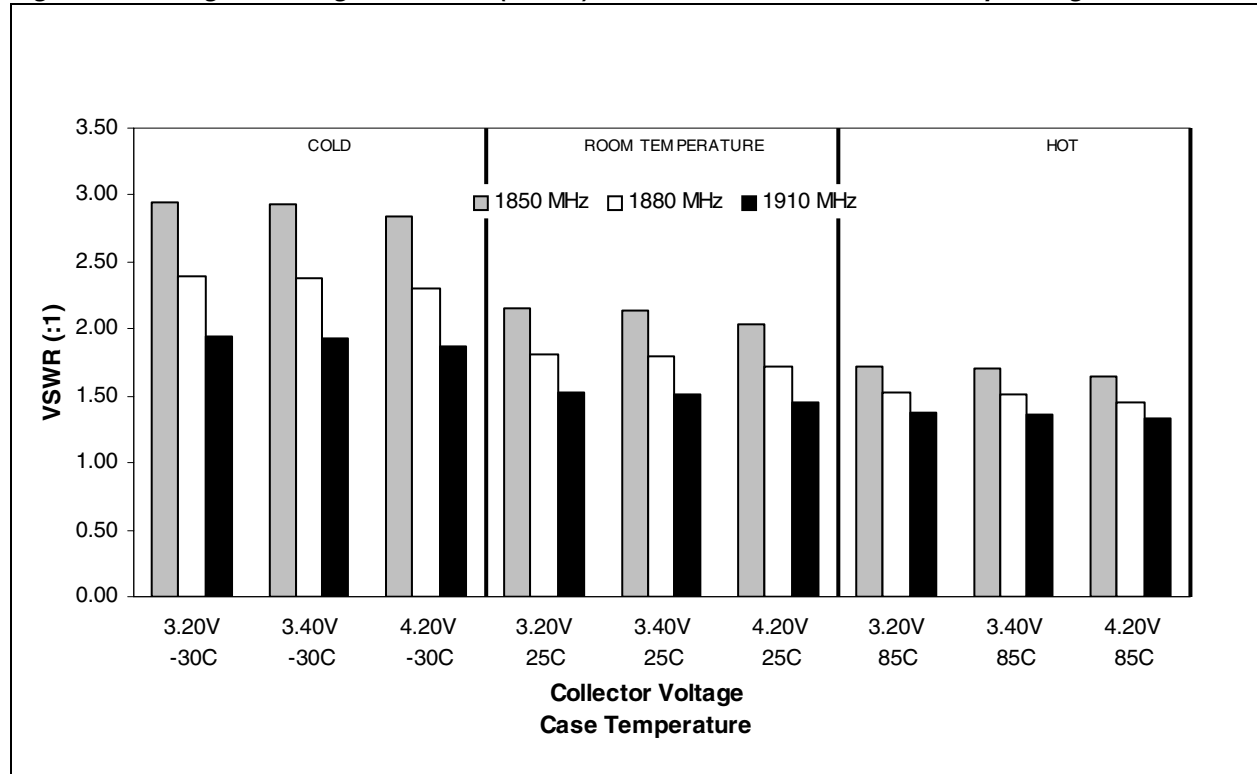

Figure 18. Voltage Standing Wave Ratio (VSWR) Variation Over Recommended Operating Conditions



Evaluation Board Design

The evaluation board is a platform for testing and interfacing design circuitry. To accommodate the interface testing of the RI23110, the evaluation board schematic and diagrams are provided for preliminary analysis and design. Figure 19 shows the basic schematic of the board for the 1720 MHz to 1910 MHz range. Figure 20 illustrates the board layout.

Figure 19. Evaluation Board Schematic

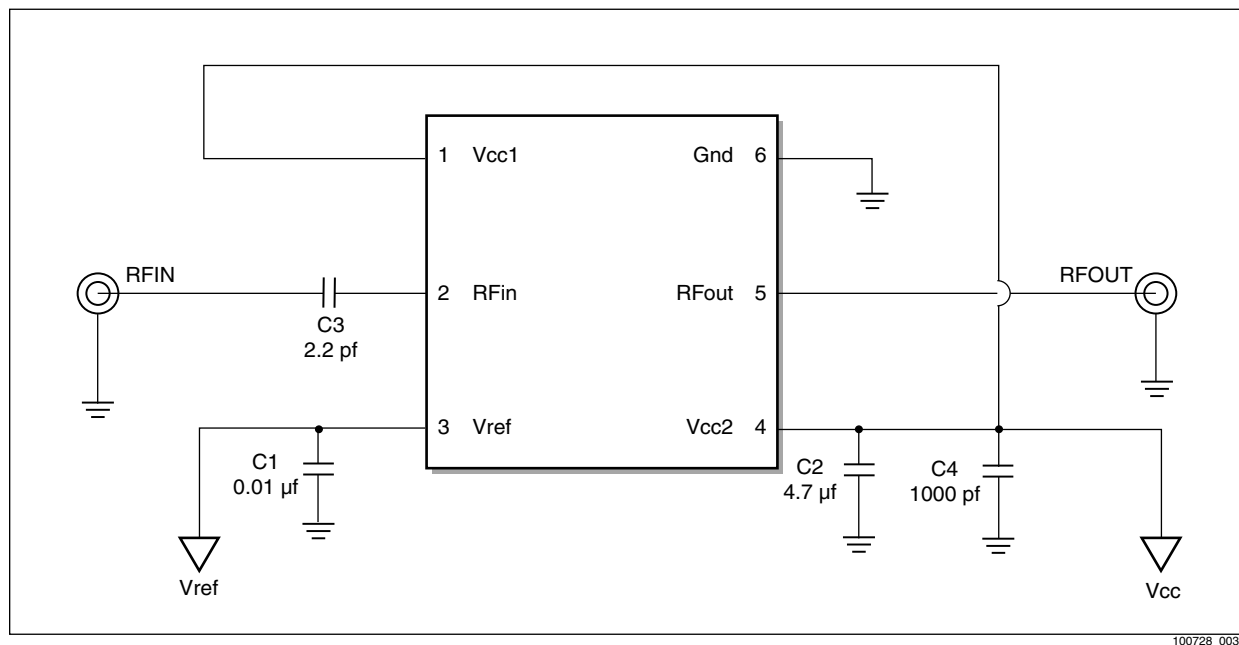

100728_003B

Figure 20. Evaluation Board Assembly Diagram

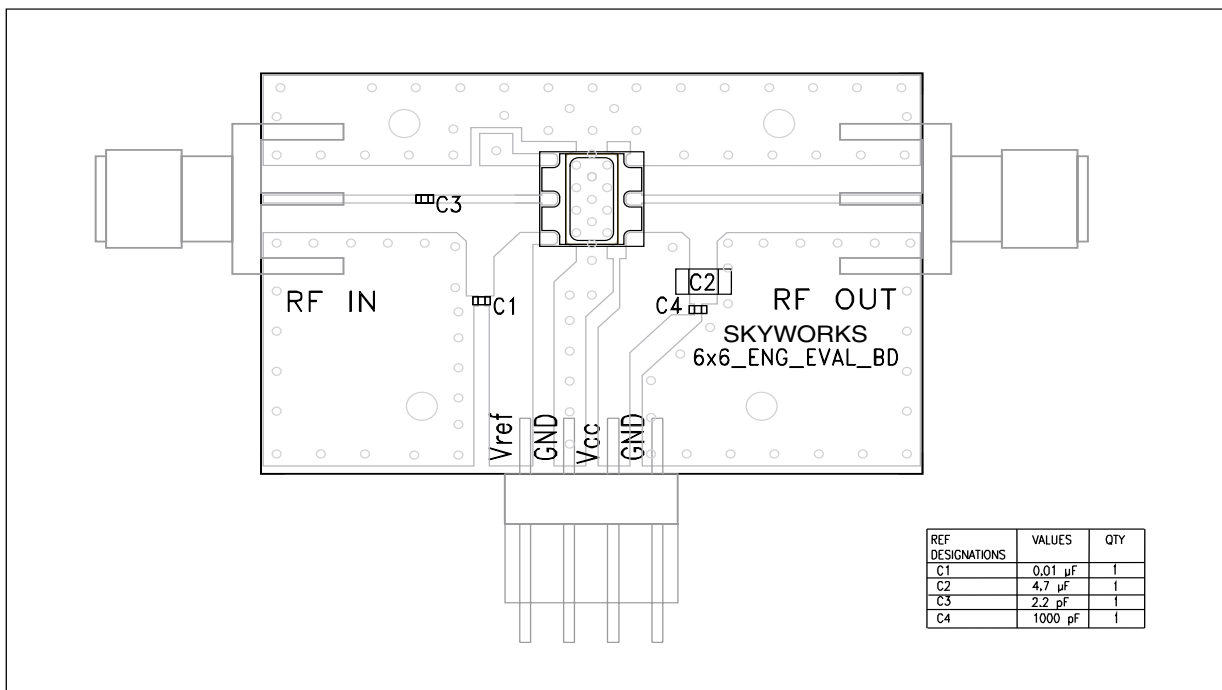

REF DESIGNATIONS	VALUES	QTY
C1	0.01 μF	1
C2	4.7 μF	1
C3	2.2 pF	1
C4	1000 pF	1

100728_004

Package Dimensions and Pin Description

The RI23110 is a ceramic base, overmold encapsulated modular package designed for surface-mount to a printed circuit board.

Care must be taken when attaching this product, whether it is done manually or in a production solder reflow environment. For pre-cautions and handling procedures recommended by Skyworks, please refer to *Application Note: PCB Design and SMT Assembly/Rework, Document Number 101752*.

Figure 21. Package Dimensions

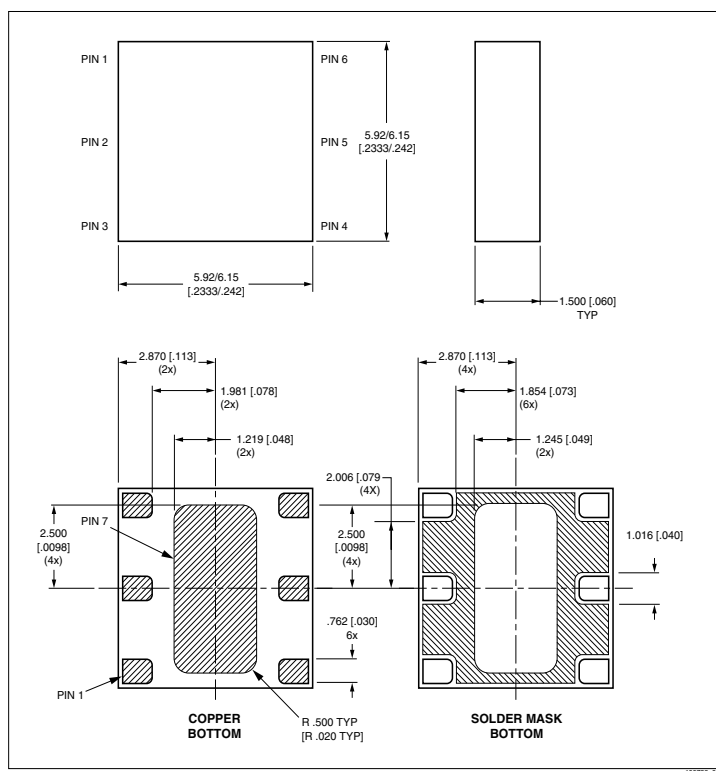
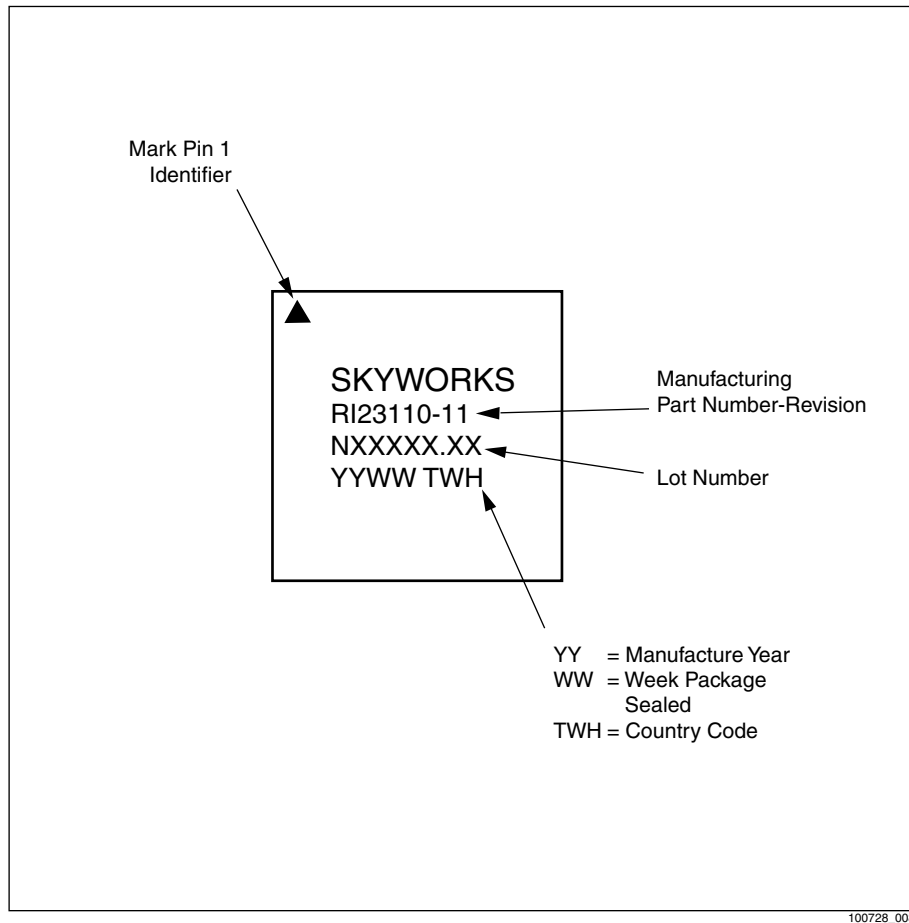

Table 8. Pin Description

Pin #	Function
1	VCC1 ⁽¹⁾
2	RF Input
3	VREF
4	VCC2 ⁽¹⁾
5	RF Output
6	GND
7	GND ⁽²⁾

NOTE(S):
⁽¹⁾ All supply pins may be connected together at the supply.
⁽²⁾ Package underside is GND.

Figure 22. Typical Case Markings



Because of its sensitivity to moisture absorption, this device package is baked and vacuum packed prior to shipment. Instructions on the shipping container label must be followed regarding exposure to moisture after the container seal is broken, otherwise, problems related to moisture absorption may occur when the part is subjected to high temperature during solder assembly.

The RI23110 is capable of withstanding an MSL 3/225 °C solder reflow. Care must be taken when attaching this product, whether it is done manually or in a production solder reflow environment. If the part is attached in a reflow oven, the temperature ramp rate should not exceed 5 °C per second; maximum temperature should not exceed 225 °C. If the part is manually attached, precaution should be taken to insure that the part is not subjected to temperatures exceeding 225 °C for more than 10 seconds. For details on both attachment techniques, precautions, and handling procedures recommended by Conexant, please refer to *Application Note: PCB Design and SMT Assembly/Rework, Document Number 101752*. Additional information on standard SMT reflow profiles can also be found in the *JEDEC Standard J-STD-020A*.

Production quantities of this product are shipped in the standard tape-and-reel format as shown in Figure 23.

Figure 23. 6x6 Tape and Reel

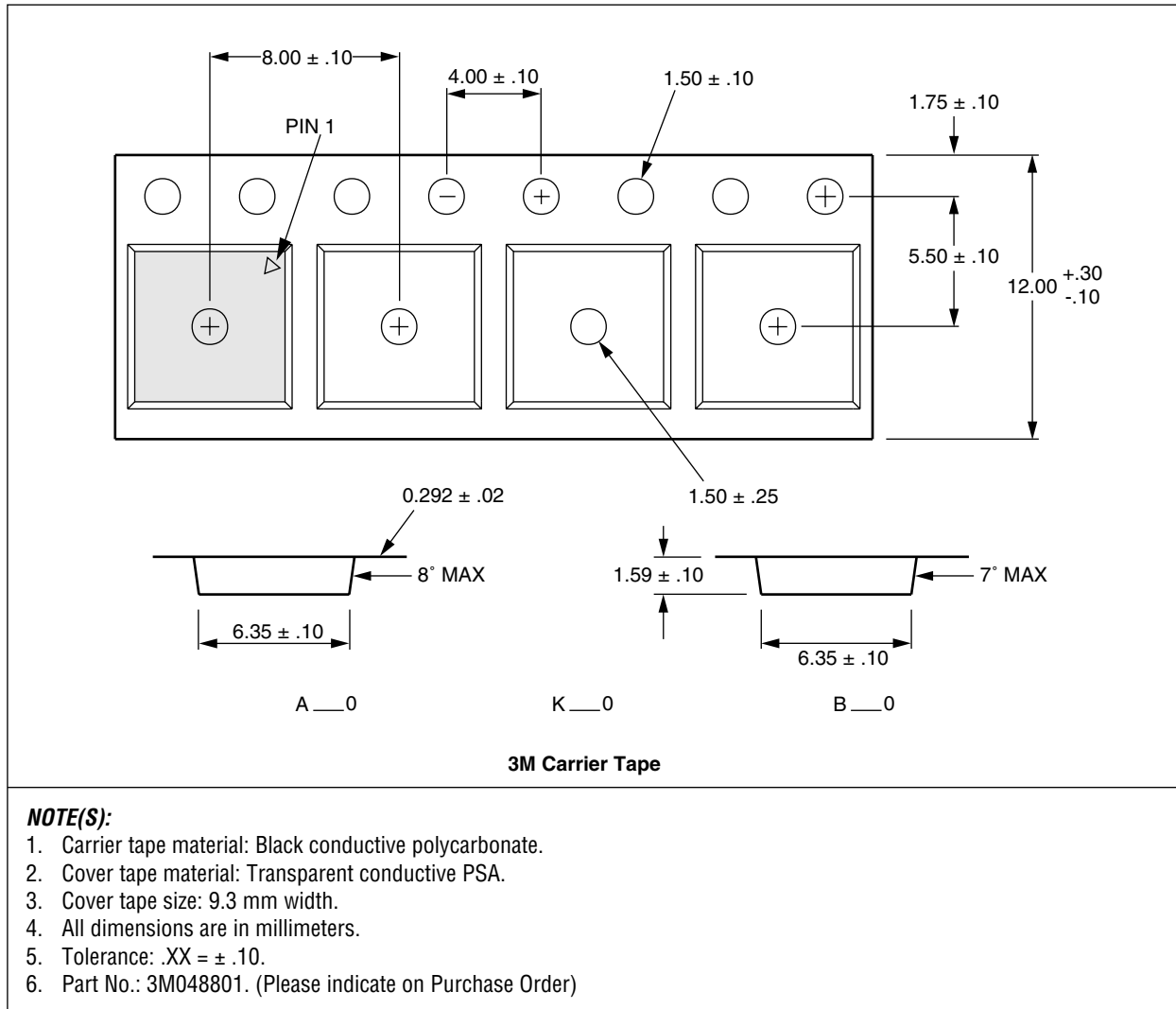

100635_005

Electrostatic Discharge Sensitivity

The RI23110 is a Class I device. Figure 24 lists the Electrostatic Discharge (ESD) immunity level for each pin of the RI23110 product. The voltages shown in Figure 24 specify the ESD threshold level for each pin where the I-V curve between the pin and ground starts to show degradation. The ESD testing was performed in compliance with MIL-STD-883E Method 3015.7 using the Human Body Model. Since 2000 volts represents the maximum measurement limit of the test equipment used, pins marked > 2000 V pass 2000V ESD stress.

Figure 24. ESD Sensitivity Areas

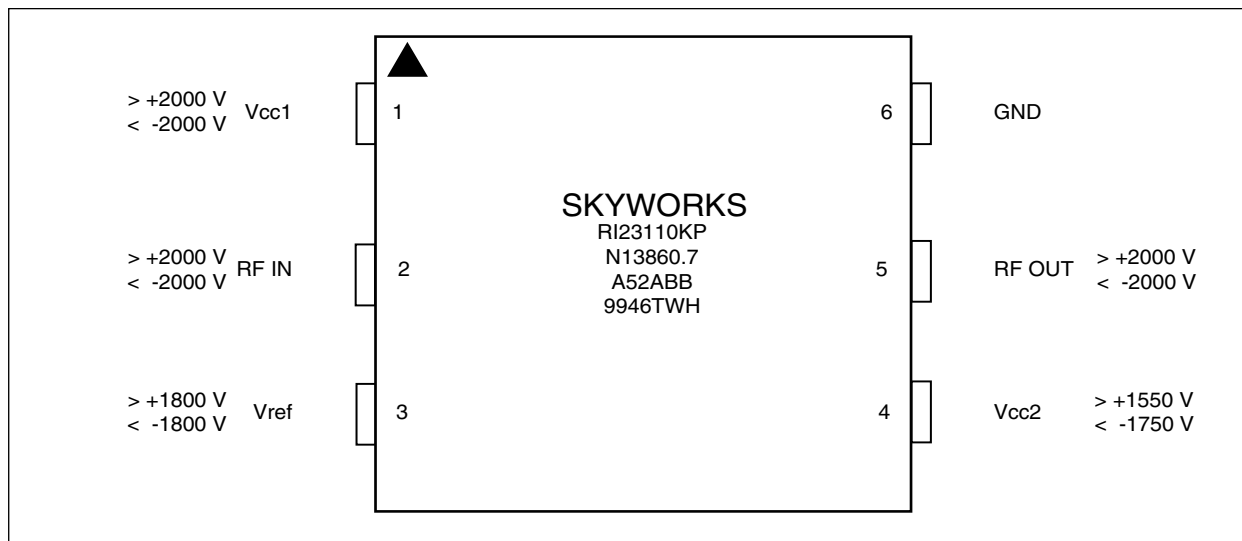

100728_009

Various failure criteria can be utilized when performing ESD testing. Many vendors employ relaxed ESD failure standards which fail devices only after “the pin fails the electrical specification limits” or “the pin becomes completely non-functional”. Skyworks employs the most stringent criteria and fails devices as soon as the pin begins to show any degradation on a curve tracer.

To avoid ESD damage, latent or visible, it is very important that the product assembly and test areas follow the Class-1 ESD handling precautions listed in Table 9.

Table 9. Precautions for GaAs ICs with ESD Thresholds Greater Than 200V But Less Than 2000V

Personnel Grounding	Facility
Wrist Straps Conductive Smocks, Gloves and Finger Cots Antistatic ID Badges	Relative Humidity Control and Air Ionizers Dissipative Floors (less than 10 ⁹ Ω to GND)
Protective Workstation	Protective Packaging & Transportation
Dissipative Table Tops Protective Test Equipment (Properly Grounded) Grounded Tip Soldering Irons Conductive Solder Suckers Static Sensors	Bags and Pouches (Faraday Shield) Protective Tote Boxes (Conductive Static Shielding) Protective Trays Grounded Carts Protective Work Order Holders

Ordering Information

Model Number	Manufacturing Part Number	Product Revision	Package	Operating Temperature
RI23110	RI23110	—	6x6CM-6	-30 °C to +85 °C

Revision History

Revision	Level	Date	Description
A		March 2000	Initial Release
B		August 2000	Added ESD data
C		December 2000	Added Solder Re-flow, Temperature Guidelines; Revised Figure 23.

Application Note: PCB Design and SMT Assembly/Rework, Document Number 101752
JEDEC Standard J-STD-020A.

© 2002, Skyworks Solutions, Inc. All Rights Reserved.

Information in this document is provided in connection with Skyworks Solutions, Inc. ("Skyworks") products. These materials are provided by Skyworks as a service to its customers and may be used for informational purposes only. Skyworks assumes no responsibility for errors or omissions in these materials. Skyworks may make changes to its products, specifications and product descriptions at any time, without notice. Skyworks makes no commitment to update the information and shall have no responsibility whatsoever for conflicts, incompatibilities, or other difficulties arising from future changes to its products and product descriptions.

No license, express or implied, by estoppel or otherwise, to any intellectual property rights is granted by this document. Except as may be provided in Skyworks' Terms and Conditions of Sale for such products, Skyworks assumes no liability whatsoever.

THESE MATERIALS ARE PROVIDED "AS IS" WITHOUT WARRANTY OF ANY KIND, EITHER EXPRESS OR IMPLIED, RELATING TO SALE AND/OR USE OF SKYWORKS™ PRODUCTS INCLUDING WARRANTIES RELATING TO FITNESS FOR A PARTICULAR PURPOSE, MERCHANTABILITY, PERFORMANCE, QUALITY OR NON-INFRINGEMENT OF ANY PATENT, COPYRIGHT OR OTHER INTELLECTUAL PROPERTY RIGHT. SKYWORKS FURTHER DOES NOT WARRANT THE ACCURACY OR COMPLETENESS OF THE INFORMATION, TEXT, GRAPHICS OR OTHER ITEMS CONTAINED WITHIN THESE MATERIALS. SKYWORKS SHALL NOT BE LIABLE FOR ANY SPECIAL, INDIRECT, INCIDENTAL, OR CONSEQUENTIAL DAMAGES, INCLUDING WITHOUT LIMITATION, LOST REVENUES OR LOST PROFITS THAT MAY RESULT FROM THE USE OF THESE MATERIALS.

Skyworks™ products are not intended for use in medical, lifesaving or life-sustaining applications. Skyworks' customers using or selling Skyworks™ products for use in such applications do so at their own risk and agree to fully indemnify Skyworks for any damages resulting from such improper use or sale.

The following are trademarks of Skyworks Solutions, Inc.: Skyworks™, the Skyworks symbol, and "Breakthrough Simplicity"™. Product names or services listed in this publication are for identification purposes only, and may be trademarks of third parties. Third-party brands and names are the property of their respective owners.

Additional information, posted at www.skyworksinc.com, is incorporated by reference.

General Information:
Skyworks Solutions, Inc.
4311 Jamboree Rd.
Newport Beach, CA. 92660-3007
www.skyworksinc.com

