

2 Watt 802.11a Packaged Amplifier

TGA2922-SG



Key Features

- 4.9 - 6 GHz Application Frequency Range
- 11 dB Nominal Gain @ 8V 480mA
- 34 dBm Nominal P1dB @ 8V 480mA
- 2.5% EVM at 25dBm output power
- IMD3 -50dBc @ 22dBm SCL, Typical
- Bias Conditions: 7-9 V @ 480 mA (Quiescent)
- 0.5 μ m HFET Technology
- 2 lead Cu base SMT package

Primary Applications

- 802.11a WLAN Bridge Amplifiers
- U-NII Band HPA
- C-Band Pt-Pt and Pt-Multi Pt Radio

Product Description

The TGA2922-SG HPA provides 11dB of gain, 2 W of output power across 4.9 - 6 GHz and 2.5% EVM at 25 dBm output power. The device is ideally suited for high linearity, high power wireless data applications such as 802.11a WLAN Bridge Amplifiers, U-NII and Point-to-Point or Point-to-Multi Point Non-Line of Sight radios. The package has a high thermal conductivity copper base. Internal partial matching simplifies system board layout by requiring a minimum of external components.

Lead-Free & RoHS compliant.

Evaluation Boards are available.

Fixtured Measured Performance

Bias Conditions: $V_d = 8$ V, $I_{dq} = 480$ mA

Performance data taken @ in a 5.75GHz application circuit

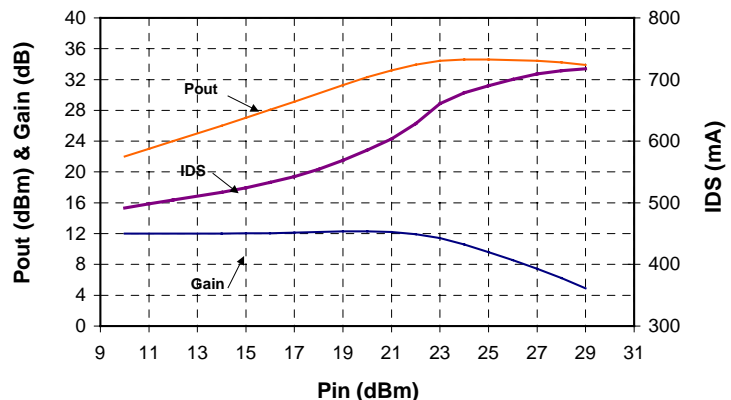
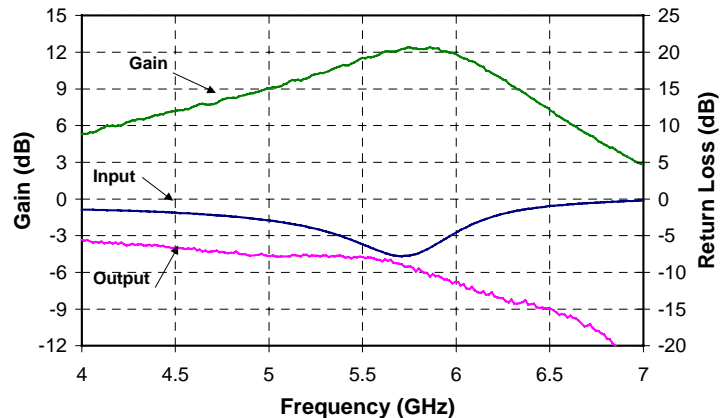

Note: This device is early in the characterization process prior to finalizing all electrical specifications. Specifications are subject to change without notice.

TABLE I
MAXIMUM RATINGS 1/

Symbol	Parameter	Value	Notes
V _d	Drain Supply Voltage	10 V	<u>2/</u>
V _g	Gate Supply Voltage Range	0 V to -5 V	
I _{dq}	Drain Supply Current (Quiescent)	1 A	<u>2/</u>
I _g	Gate Current	19 mA	
P _{IN}	Input Continuous Wave Power	30 dBm	<u>2/</u>
P _D	Power Dissipation	4.1 W	<u>2/</u> , <u>3/</u>
T _{CH}	Operating Channel Temperature	175 °C	<u>4/</u>
T _M	Mounting Temperature (30 Seconds)	260 °C	
T _{STG}	Storage Temperature	-65 to 150 °C	

1/ These ratings represent the maximum operable values for this device.

2/ Combinations of supply voltage, supply current, input power, and output power shall not exceed P_D.

3/ When operated at this bias condition with a base plate temperature of 85 °C, the MTTF life is 2 E+8 hours.

4/ Junction operating temperature will directly affect the device median time to failure (T_M). For maximum life, it is recommended that junction temperatures be maintained at the lowest possible levels.

TABLE II
RF CHARACTERIZATION TABLE
($T_A = 25^\circ\text{C}$, Nominal)
($V_d = 8\text{ V}$, $I_{dq} = 480\text{ mA}$)

SYMBOL	PARAMETER	TEST CONDITION	TYPICAL	UNITS
Gain	Small Signal Gain	F = 5.75 GHz	11	dB
IRL	Input Return Loss	F = 5.75 GHz	7	dB
ORL	Output Return Loss	F = 5.75 GHz	7	dB
P1dB	Output Power @ P1dB	F = 5.75 GHz	34	dBm

TABLE III
THERMAL INFORMATION

Parameter	Test Conditions	T_{CH} ($^\circ\text{C}$)	$R_{\theta JC}$ ($^\circ\text{C/W}$)	T_M (HRS)
$R_{\theta JC}$ Thermal Resistance (channel to backside of package)	$V_d = 8\text{ V}$ $I_D = 480\text{ mA}$ (Quiescent) $P_{diss} = 3.8\text{ W}$	168	22	4 E+8

Note: Package backside SnPb soldered to carrier at 85°C baseplate temperature. At saturated output power, the DC power consumption is 5.8 W with 2 W RF power delivered to the load. Power dissipated is 3.8 W and the temperature rise in the channel is 84°C .

Measured Fixtured Data
Application Circuit tuned to 5.75 GHz

Bias Conditions: Vd = 7 V, Idq = 480 mA

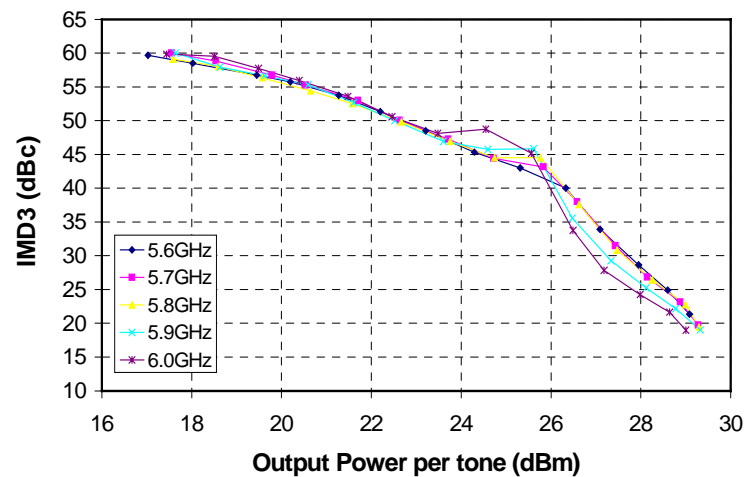
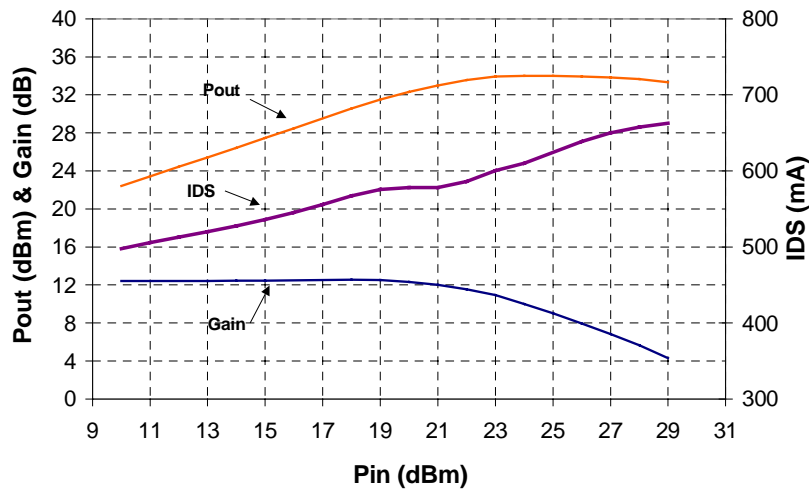
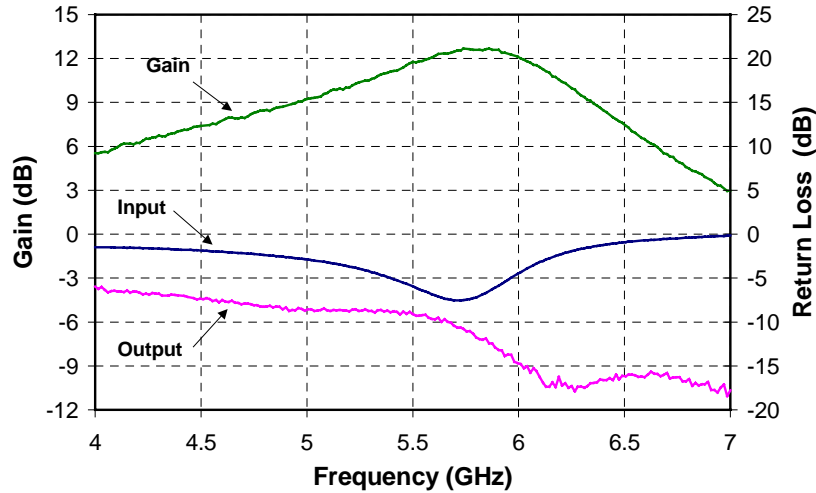

Measured Fixtured Data
Application Circuit tuned to 5.75 GHz

Bias Conditions: $V_d = 8\text{ V}$, $I_{dq} = 480\text{ mA}$

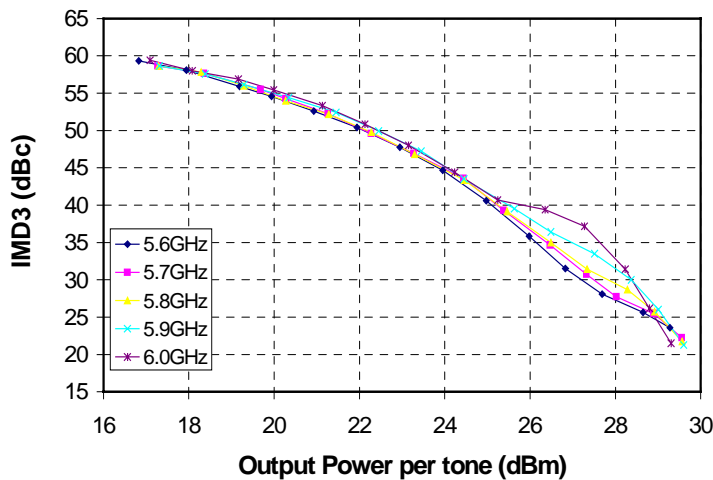
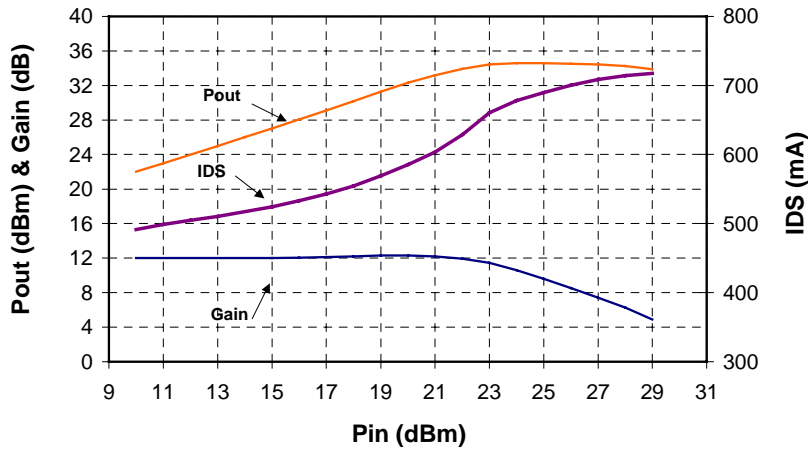
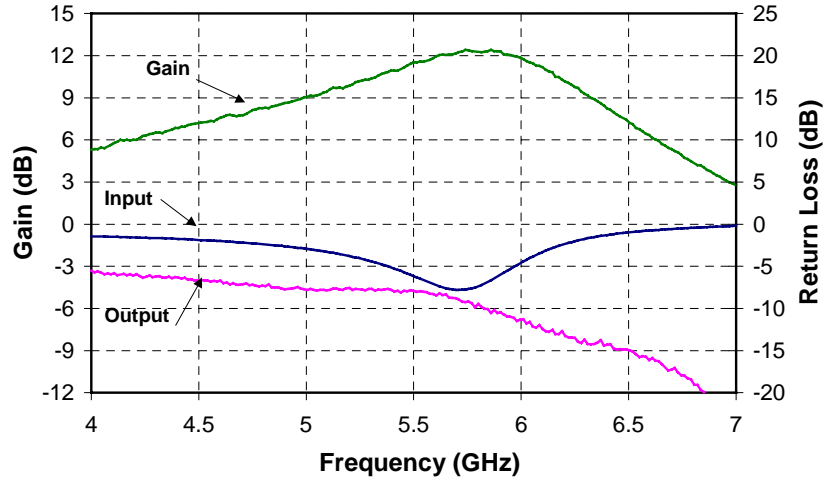

Measured Fixtured Data
Application Circuit tuned to 5.75 GHz

Bias Conditions: $V_d = 8\text{ V}$, $I_{dq} = 480\text{ mA}$

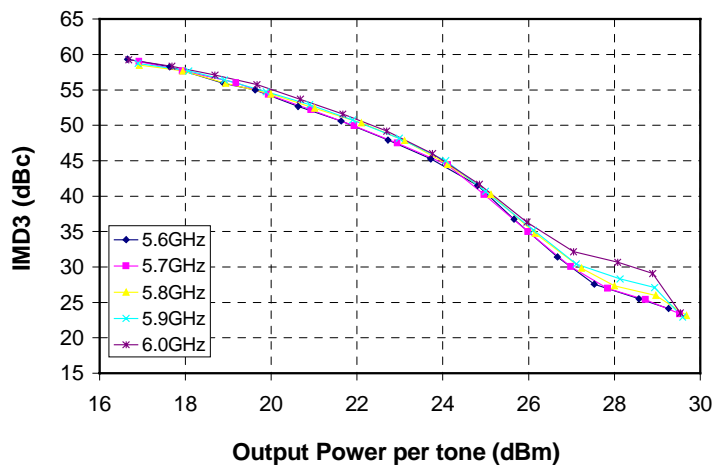
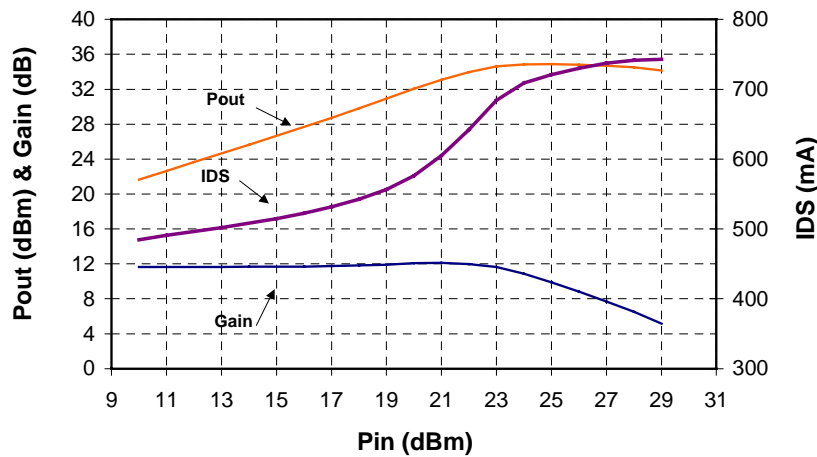
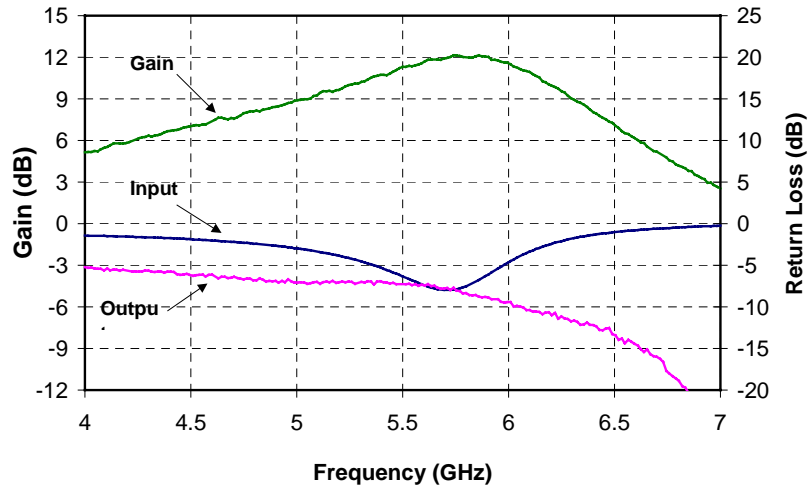

Measured Fixtured Data
Application Circuit tuned to 5.75 GHz

Bias Conditions: $V_d = 8\text{ V}$, $I_{dq} = 480\text{ mA}$

OFDM 64 QAM

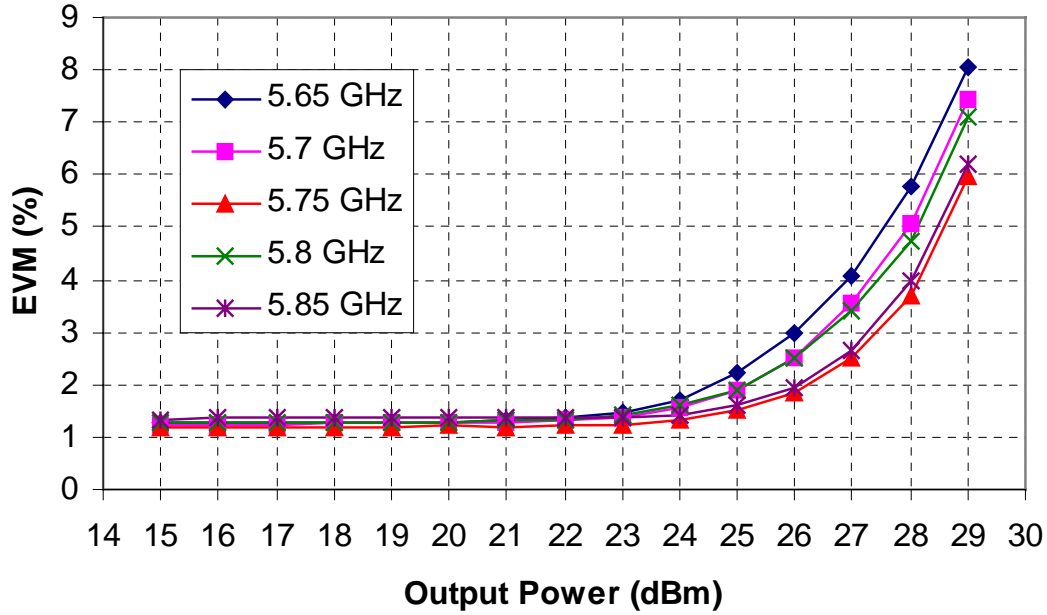

S-Parameter Data

Bias Conditions: Vd = 8V, Idq = 480 mA

Frequency GHz	S11		S21		S12		S22	
	Mag (dB)	Deg	Mag (dB)	Deg	Mag (dB)	Deg	Mag (dB)	Deg
2	-1.064	159.46	8.711	24.329	-30.877	-37.657	-5.692	164.69
2.2	-1.097	152.93	7.986	16.119	-30.802	-40.661	-5.391	161.15
2.4	-1.121	146.43	7.341	7.38	-31.149	-47.878	-5.193	157.74
2.6	-1.158	139.91	6.781	-0.744	-31.068	-51.566	-5	154.45
2.8	-1.148	133.37	6.261	-9.122	-31.133	-60.217	-4.851	150.4
3	-1.187	126.29	5.795	-17.347	-31.547	-62.038	-4.653	146.75
3.2	-1.256	118.87	5.41	-25.881	-31.602	-67.517	-4.47	143.06
3.4	-1.308	111.87	5.055	-34.21	-30.933	-72.012	-4.386	140.23
3.6	-1.319	104.46	4.757	-42.632	-31.724	-75.875	-4.268	136.38
3.8	-1.349	96.508	4.499	-51.255	-30.792	-84.39	-4.26	132.8
4	-1.367	88.673	4.273	-60.27	-31.334	-89.74	-4.279	128.97
4.2	-1.291	80.496	4.131	-69.363	-31.513	-97.338	-4.206	124.8
4.4	-1.299	72.709	3.994	-78.577	-31.395	-103.45	-4.239	120.77
4.6	-1.318	65.357	3.845	-88.02	-31.303	-107.77	-4.261	116.11
4.8	-1.192	58.18	3.784	-97.07	-32.059	-114.7	-4.288	110.84
5	-1.182	51.453	3.838	-106.89	-31.656	-120.07	-4.515	105.45
5.2	-1.235	45.268	3.87	-116.75	-32.521	-123.03	-4.643	99.838
5.4	-1.247	39.194	4.068	-127.04	-32.507	-131.7	-4.746	94.391
5.6	-1.312	33.505	4.469	-137.12	-32.851	-133.64	-4.955	88.582
5.8	-1.572	27.224	5.407	-147.36	-32.677	-145.33	-5.109	84.622
6	-2.144	18.052	7.048	-163.92	-33.493	-158.52	-4.447	82.265
6.2	-3.929	0.706	9.007	173.85	-36.037	-172.13	-4.587	75.642
6.4	-16.53	-70.915	11.343	131.87	-47.443	-136.43	-4.953	73.309
6.6	-3.064	107.16	8.577	71.657	-34.576	-106.6	-4.3	78.064
6.8	-0.629	77.321	2.49	37.621	-33.05	-128.44	-3.285	76.841
7	-0.265	65.853	-3.052	18.739	-33.513	-143.12	-2.722	75.552
7.2	-0.219	59.846	-8.546	6.741	-34.784	-146.11	-2.165	75.642
7.4	-0.317	56.083	-14.725	4.867	-35.404	-151.89	-1.72	76.43
7.6	-1.162	54.327	-15.078	45.009	-33.594	-123.56	-1.219	78.725
7.8	-0.616	60.535	-16.014	-9.842	-31.155	-155.16	-0.837	79.245
8	-0.392	60.121	-22.085	-26.956	-31.923	-159.11	-0.663	81.487
8.2	-0.402	61.336	-27.313	-38.375	-32.698	-159.63	-0.497	83.83
8.4	-0.367	64.333	-32.49	-62.676	-31.776	-162.16	-0.396	86.319
8.6	-0.286	68.382	-35.569	-110.66	-31.509	-164.23	-0.278	88.199
8.8	-0.23	73.502	-32.658	-144.4	-30.737	-164.75	-0.249	89.022
9	-0.108	79.406	-31.547	-167.6	-29.564	-168.44	-0.325	88.608

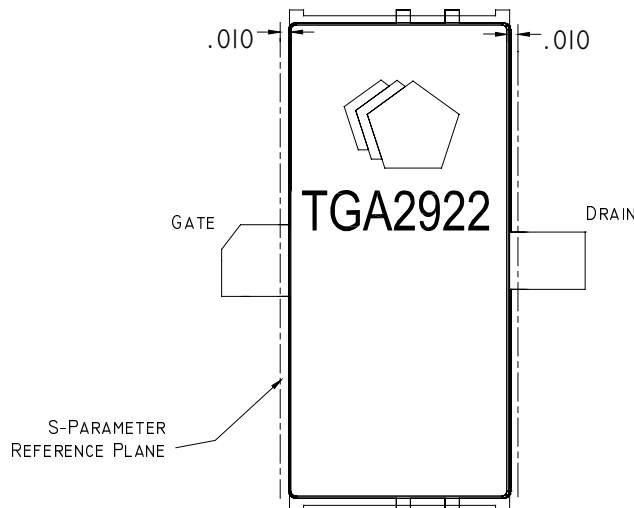

Packaged Dimensional Drawing TGA2922 - SG

Top
View

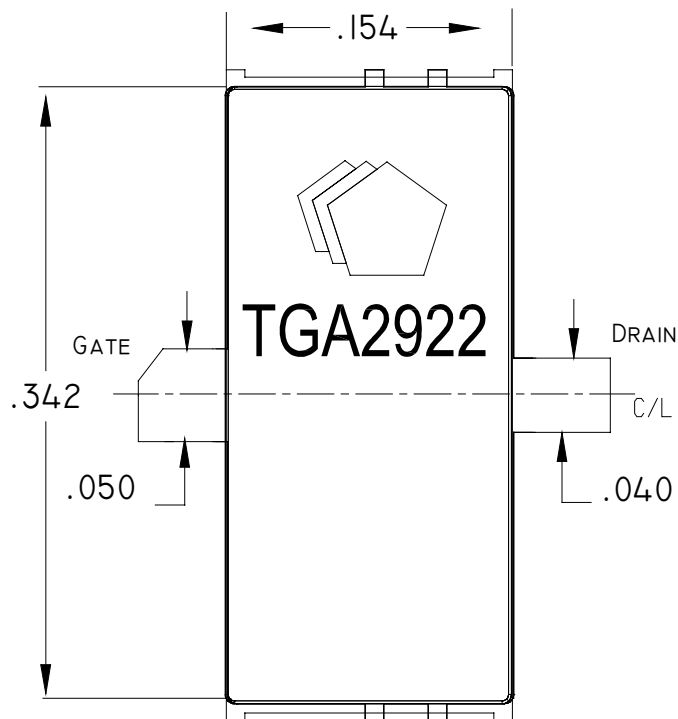

Side
View

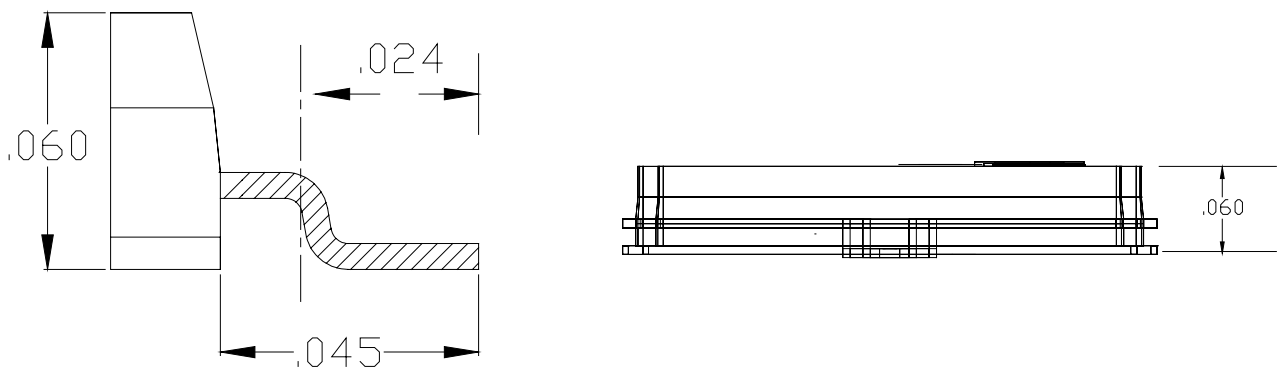

Bias Procedure

1. Ensure no RF power is applied to the device.
2. Pinch off device by setting V_g to $-3V$.
3. Increase V_d to 8.0V while monitoring drain current.
4. Increase V_g until drain current reaches 480 mA.
5. Apply RF power.

GaAs MMIC devices are susceptible to damage from Electrostatic Discharge. Proper precautions should be observed during handling, assembly and test.

5.8 GHz Application Circuit Schematic

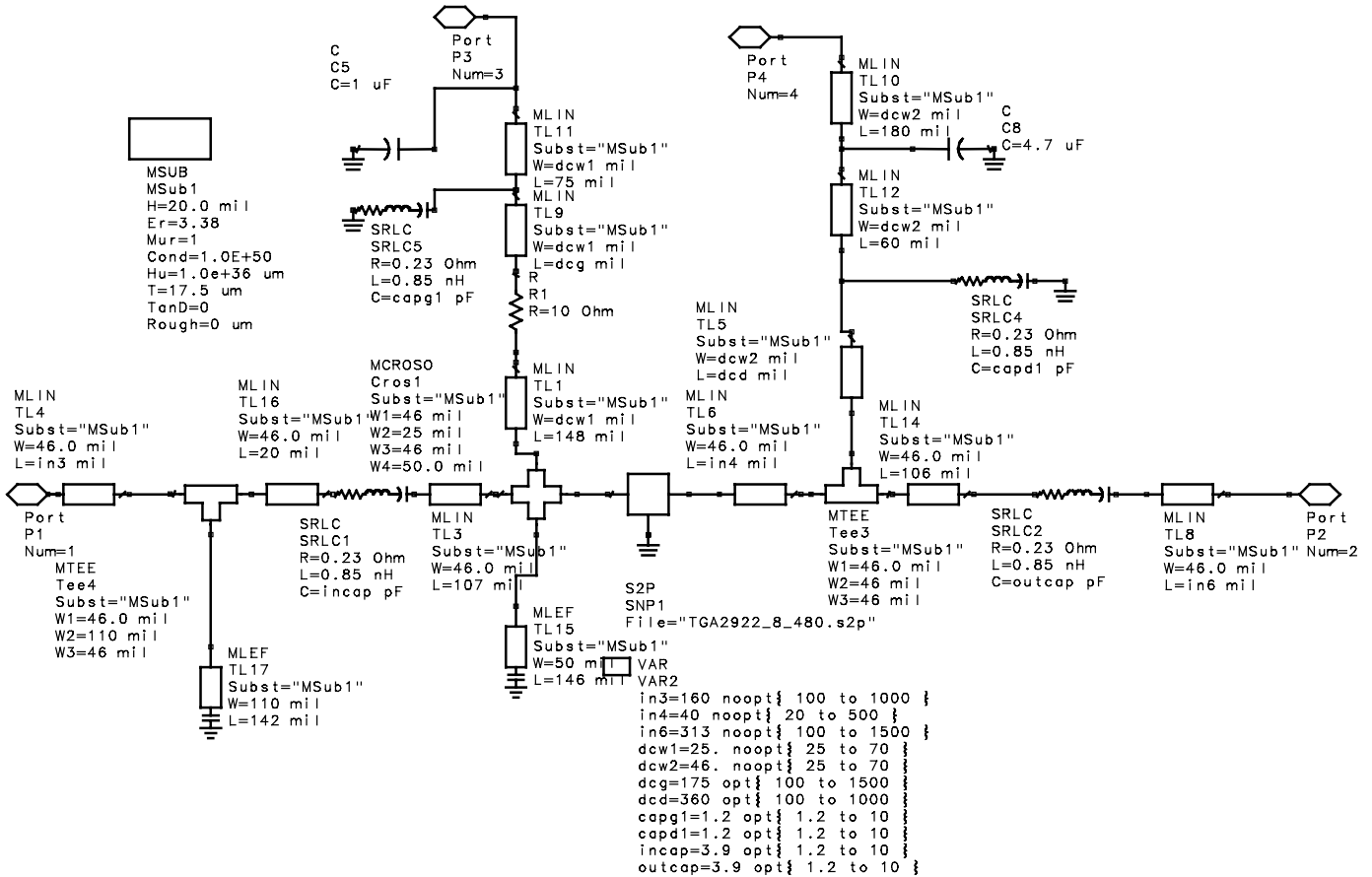

PCB is 20 mil thick Rogers 4003 substrate. The schematic is for small signal approach only

Typical Evaluation Board Layout *

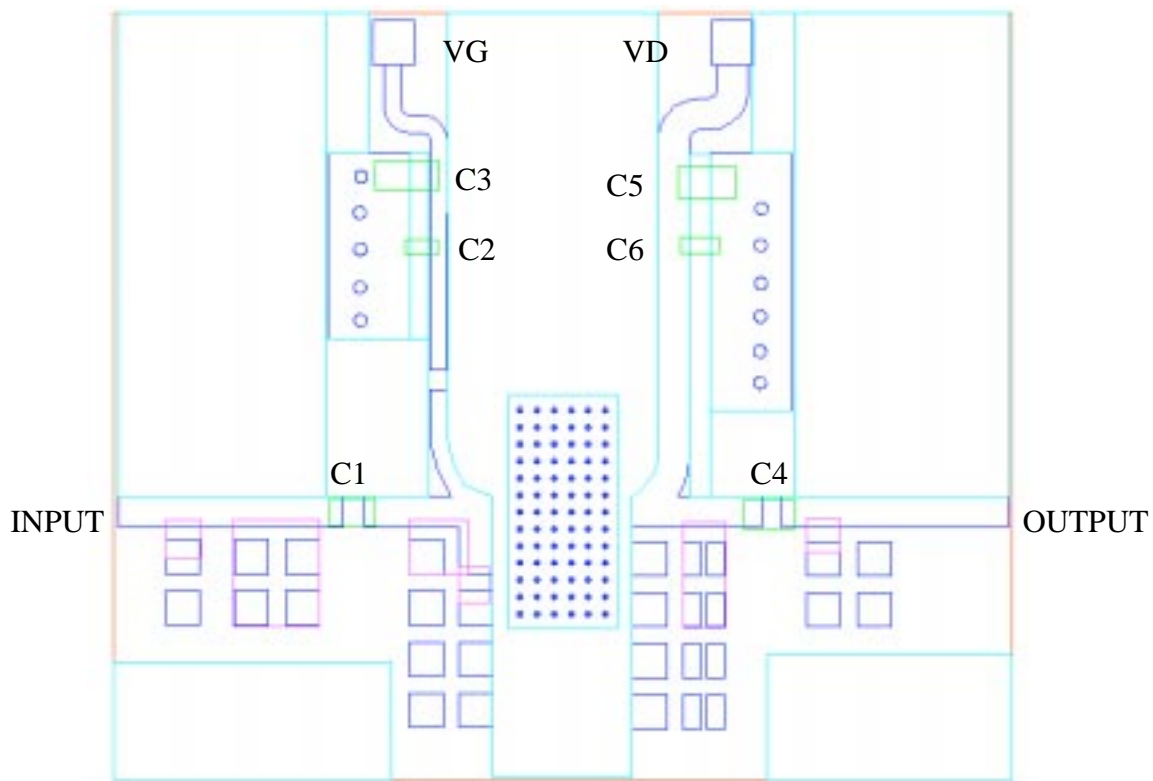

*The layout is a general purpose drawing that needs to be tuned for the specific application. PCB is RO4003 20 mil thickness, 0.5 oz standard copper cladding, with $E_r = 3.38$.

External Component Listing

Part Type	Reference	Description
Capacitor	C1	AVX06035J3R9BBT, 3.9 pF
Capacitor	C2	AVX06035J1R2BBT, 1.2 pF
Capacitor	C3	1uF
Capacitor	C4	AVX06035J3R9BBT, 3.9 pF
Capacitor	C5	4.7 uF
Capacitor	C6	AVX06035J1R2BBT, 1.2 pF
Resistor	R1	0805, 10 Ω

Contact TriQuint Applications Engineering for additional info

Recommended Surface Mount Package Assembly

Proper ESD precautions must be followed while handling packages.

Clean the board with acetone. Rinse with alcohol. Allow the circuit to fully dry.

TriQuint recommends using a conductive solder paste for attachment. Follow solder paste and reflow oven vendors' recommendations when developing a solder reflow profile. Typical solder reflow profiles are listed in the table below.

Hand soldering is not recommended. Solder paste can be applied using a stencil printer or dot placement. The volume of solder paste depends on PCB and component layout and should be well controlled to ensure consistent mechanical and electrical performance.

Clean the assembly with alcohol.

Typical Solder Reflow Profiles

Reflow Profile	SnPb	Pb Free
Ramp-up Rate	3 °C/sec	3 °C/sec
Activation Time and Temperature	60 – 120 sec @ 140 – 160 °C	60 – 180 sec @ 150 – 200 °C
Time above Melting Point	60 – 150 sec	60 – 150 sec
Max Peak Temperature	240 °C	260 °C
Time within 5 °C of Peak Temperature	10 – 20 sec	10 – 20 sec
Ramp-down Rate	4 – 6 °C/sec	4 – 6 °C/sec

Ordering Information

Part	Package Style
TGA2922-SG	SMT Gull Wing (Formed Leads)