

Features

- Epitaxial Planar Die Construction
- Complementary PNP Types Available (DDTA)
- Built-In Biasing Resistors, R1 = R2

Mechanical Data

- Case: SOT-23, Molded Plastic
- Case material - UL Flammability Rating 94V-0
- Moisture sensitivity: Level 1 per J-STD-020A
- Terminals: Solderable per MIL-STD-202, Method 208
- Terminal Connections: See Diagram
- Marking: Date Code and Marking Code (See Diagrams & Page 2)
- Weight: 0.008 grams (approx.)
- Ordering Information (See Page 2)

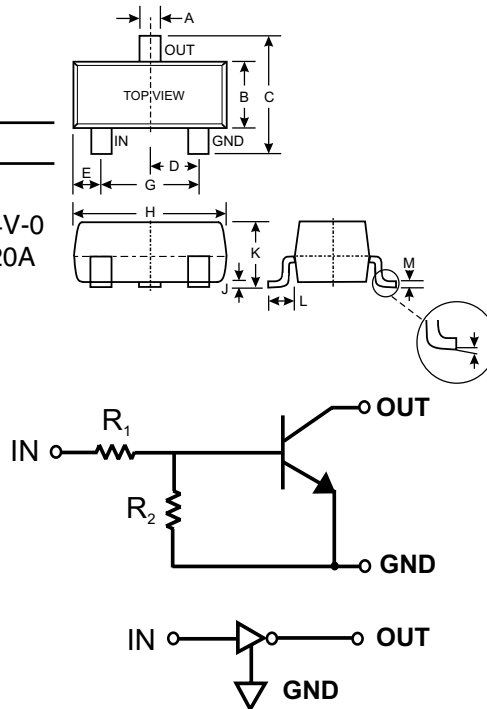

SOT-23		
Dim	Min	Max
A	0.37	0.51
B	1.20	1.40
C	2.30	2.50
D	0.89	1.03
E	0.45	0.60
G	1.78	2.05
H	2.80	3.00
J	0.013	0.10
K	0.89	1.00
L	0.45	0.61
M	0.085	0.110
α	0°	8°
All Dimensions in mm		

P/N	R1, R2 (NOM)	MARKING
DDTC123ECA	2.2K Ω	N04
DDTC143ECA	4.7K Ω	N08
DDTC114ECA	10K Ω	N13
DDTC124ECA	22K Ω	N17
DDTC144ECA	47K Ω	N20
DDTC115ECA	100K Ω	N24

SCHEMATIC DIAGRAM

Maximum Ratings @ T_A = 25°C unless otherwise specified

Characteristic	Symbol	Value	Unit
Supply Voltage, (3) to (1)	V _{CC}	50	V
Input Voltage, (2) to (1)	V _{IN}	-10 to +12 -10 to +30 -10 to +40 -10 to +40 -10 to +40 -10 to +40 -10 to +40	V
Output Current	I _O	100 100 50 30 100 20	mA
Output Current	I _C (Max)	100	mA
Power Dissipation	P _d	200	mW
Thermal Resistance, Junction to Ambient Air (Note 1)	R _{θJA}	625	°C/W
Operating and Storage and Temperature Range	T _J , T _{STG}	-55 to +150	°C

Note: 1. Mounted on FR4 PC Board with recommended pad layout at <http://www.diodes.com/datasheets/ap02001.pdf>.

Electrical Characteristics @ $T_A = 25^\circ\text{C}$ unless otherwise specified

Characteristic		Symbol	Min	Typ	Max	Unit	Test Condition
Input Voltage		$V_{I(off)}$	0.5	1.1	—	V	$V_{CC} = 5V, I_O = 100\mu A$
		$V_{I(on)}$	—	1.9	3		$V_O = 0.3V, I_O = 20mA, DDTC123ECA$ $V_O = 0.3V, I_O = 20mA, DDTC143ECA$ $V_O = 0.3V, I_O = 10mA, DDTC114ECA$ $V_O = 0.3V, I_O = 5mA, DDTC124ECA$ $V_O = 0.3V, I_O = 2mA, DDTC144ECA$ $V_O = 0.3V, I_O = 1mA, DDTC115ECA$
Output Voltage		$V_{O(on)}$	—	0.1	0.3	V	$I_O/I_I = 10mA/0.5mA, DDTC123ECA$ $I_O/I_I = 10mA/0.5mA, DDTC143ECA$ $I_O/I_I = 10mA/0.5mA, DDTC114ECA$ $I_O/I_I = 10mA/0.5mA, DDTC124ECA$ $I_O/I_I = 10mA/0.5mA, DDTC144ECA$ $I_O/I_I = 5mA/0.25mA, DDTC115ECA$
Input Current	DDTC123ECA DDTC143ECA DDTC114ECA DDTC124ECA DDTC144ECA DDTC115ECA	I_I	—	—	3.8 1.8 0.88 0.36 0.18 0.15	mA	$V_I = 5V$
Output Current		$I_{O(off)}$	—	—	0.5	μA	$V_{CC} = 50V, V_I = 0V$
DC Current Gain	DDTC123ECA DDTC143ECA DDTC114ECA DDTC124ECA DDTC144ECA DDTC115ECA	G_I	20 20 30 56 68 82	—	—	—	$V_O = 5V, I_O = 20mA$ $V_O = 5V, I_O = 10mA$ $V_O = 5V, I_O = 5mA$ $V_O = 5V, I_O = 5mA$ $V_O = 5V, I_O = 5mA$ $V_O = 5V, I_O = 5mA$
Input Resistor (R_1) Tolerance		ΔR_1	-30	—	+30	%	—
Resistance Ratio		R_2/R_1	0.8	1	1.2	—	—
Gain-Bandwidth Product*		f_T	—	250	—	MHz	$V_{CE} = 10V, I_E = 5mA,$ $f = 100MHz$

* Transistor - For Reference Only

Ordering Information (Note 2)

Device	Packaging	Shipping
DDTC123ECA-7	SOT-23	3000/Tape & Reel
DDTC143ECA-7	SOT-23	3000/Tape & Reel
DDTC114ECA-7	SOT-23	3000/Tape & Reel
DDTC124ECA-7	SOT-23	3000/Tape & Reel
DDTC144ECA-7	SOT-23	3000/Tape & Reel
DDTC115ECA-7	SOT-23	3000/Tape & Reel

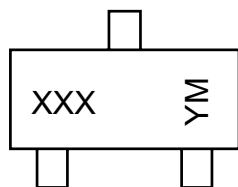
Notes: 2. For Packaging Details, go to our website at <http://www.diodes.com/datasheets/ap02007.pdf>.**Marking Information**

XXX = Product Type Marking Code
See Sheet 1 Diagrams
YM = Date Code Marking
Y = Year ex: N = 2002
M = Month ex: 9 = September

Date Code Key

Year	2002	2003	2004	2005	2006	2007	2008	2009
Code	N	P	R	S	T	U	V	W

Month	Jan	Feb	March	Apr	May	Jun	Jul	Aug	Sep	Oct	Nov	Dec
Code	1	2	3	4	5	6	7	8	9	O	N	D

TYPICAL CURVES - DDTCT143ECA

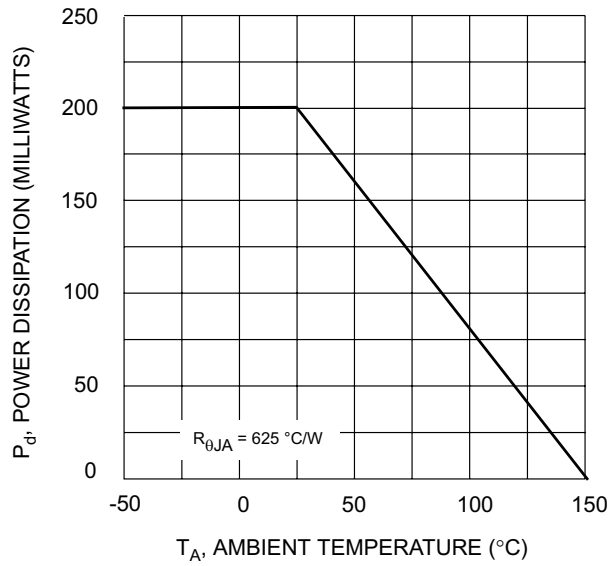

Fig. 1 Derating Curve

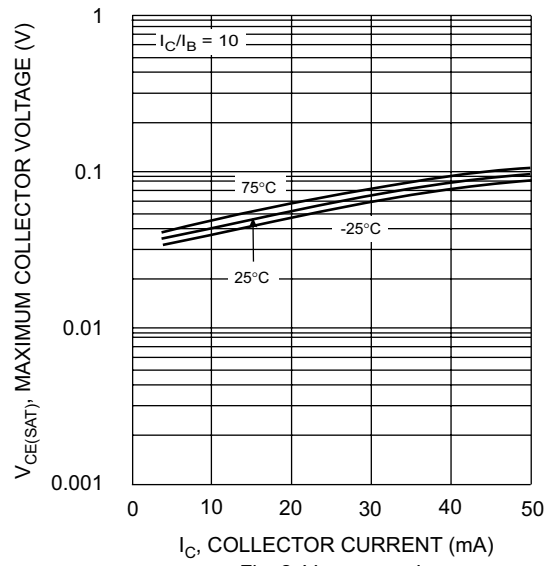

Fig. 2 $V_{CE(SAT)}$ vs. I_C

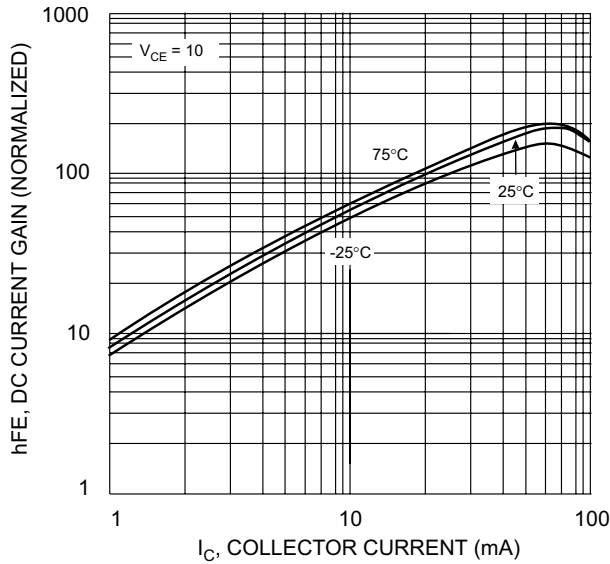

Fig. 3 DC CURRENT GAIN

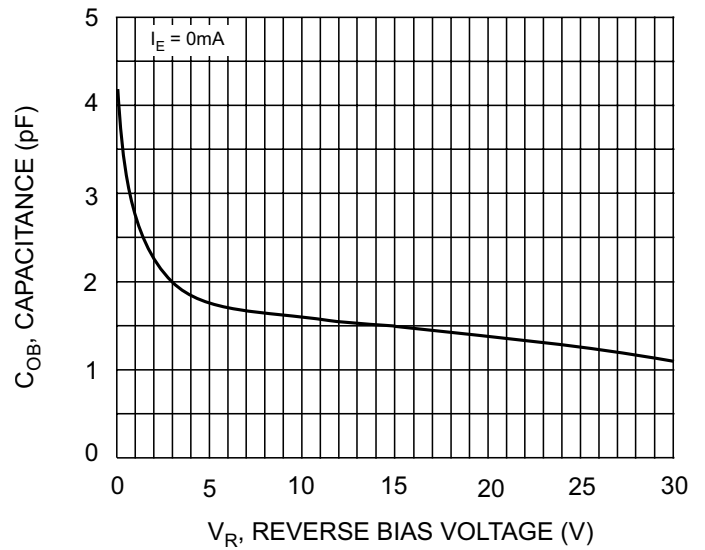

Fig. 4 Output Capacitance

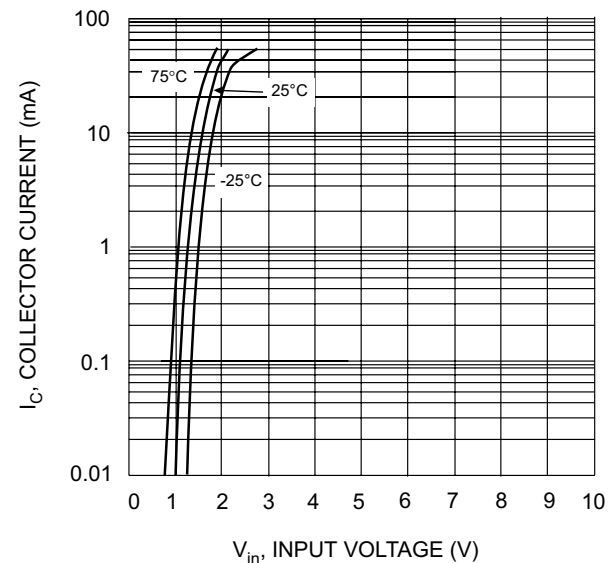

Fig. 5 Collector Current Vs. Input Voltage

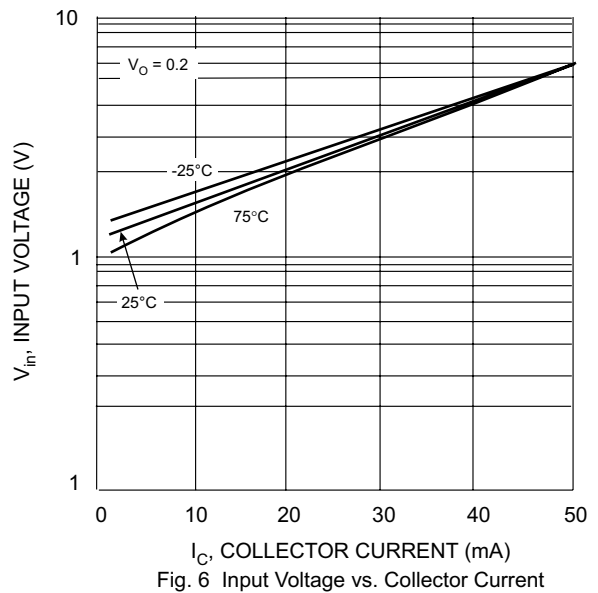

Fig. 6 Input Voltage vs. Collector Current