

P-Channel 1.8-V (G-S) MOSFET

TrenchFET®
Power MOSFETs
1.8-V Rated

PRODUCT SUMMARY		
V_{DS} (V)	$r_{DS(on)}$ (Ω)	I_D (A)
-12	0.014 @ $V_{GS} = -4.5$ V	± 8.0
	0.019 @ $V_{GS} = -2.5$ V	± 7.0
	0.027 @ $V_{GS} = -1.8$ V	± 5.8

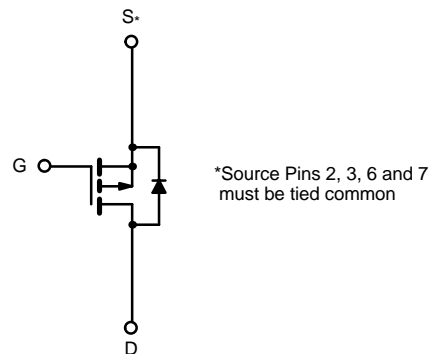
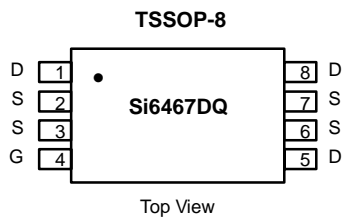

ABSOLUTE MAXIMUM RATINGS ($T_A = 25^\circ\text{C}$ UNLESS OTHERWISE NOTED)			
Parameter	Symbol	Limit	Unit
Drain-Source Voltage	V_{DS}	-12	V
Gate-Source Voltage	V_{GS}	± 8	
Continuous Drain Current ($T_J = 150^\circ\text{C}$) ^{a, b}	$T_A = 25^\circ\text{C}$	± 8.0	A
	$T_A = 70^\circ\text{C}$	± 6.5	
Pulsed Drain Current	I_{DM}	± 30	
Continuous Source Current (Diode Conduction) ^{a, b}	I_S	-1.5	W
Maximum Power Dissipation ^{a, b}	$T_A = 25^\circ\text{C}$	1.5	
	$T_A = 70^\circ\text{C}$	1.0	
Operating Junction and Storage Temperature Range	T_J, T_{stg}	-55 to 150	$^\circ\text{C}$

THERMAL RESISTANCE RATINGS					
Parameter	Symbol	Typical	Maximum	Unit	
Maximum Junction-to-Ambient ^a	R_{thJA}	90	83	$^\circ\text{C/W}$	
				Steady State	

Notes
a. Surface Mounted on FR4 Board.
b. $t \leq 10$ sec.



SPECIFICATIONS (T_J = 25 °C UNLESS OTHERWISE NOTED)

Parameter	Symbol	Test Condition	Min	Typ	Max	Unit
Static						
Gate Threshold Voltage	V _{GS(th)}	V _{DS} = V _{GS} , I _D = -250 μA	-0.45			V
Gate-Body Leakage	I _{GSS}	V _{DS} = 0 V, V _{GS} = ±8 V			± 100	nA
Zero Gate Voltage Drain Current	I _{DSS}	V _{DS} = -9.6 V, V _{GS} = 0 V			-1	μA
		V _{DS} = -9.6 V, V _{GS} = 0 V, T _J = 70 °C			-25	
On-State Drain Current ^a	I _{D(on)}	V _{DS} ≥ -5 V, V _{GS} = -4.5 V	-20			A
Drain-Source On-State Resistance ^a	r _{DS(on)}	V _{GS} = -4.5 V, I _D = -8.0 A		0.0105	0.014	Ω
		V _{GS} = -2.5 V, I _D = -7.0 A		0.014	0.019	
		V _{GS} = -1.8 V, I _D = -5.8 A		0.020	0.027	
Forward Transconductance ^a	g _{fs}	V _{DS} = -5 V, I _D = -8.0 A		34		S
Diode Forward Voltage ^a	V _{SD}	I _S = -1.5 A, V _{GS} = 0 V		0.65	-1.1	V
Dynamic^b						
Total Gate Charge	Q _g	V _{DS} = -6 V, V _{GS} = -4.5 V, I _D = -8.0 A		49	80	nC
Gate-Source Charge	Q _{gs}			9		
Gate-Drain Charge	Q _{gd}			6.5		
Turn-On Delay Time	t _{d(on)}	V _{DD} = -6 V, R _L = 6 Ω I _D ≅ -1 A, V _{GEN} = -4.5 V, R _G = 6 Ω		40	70	ns
Rise Time	t _r			50	100	
Turn-Off Delay Time	t _{d(off)}			220	400	
Fall Time	t _f			105	200	
Source-Drain Reverse Recovery Time	t _{rr}		I _F = -1.5 A, di/dt = 100 A/μs		70	

Notes

- a. Pulse test; pulse width ≤ 300 μs, duty cycle ≤ 2%.
- b. Guaranteed by design, not subject to production testing.



TYPICAL CHARACTERISTICS (25°C UNLESS NOTED)

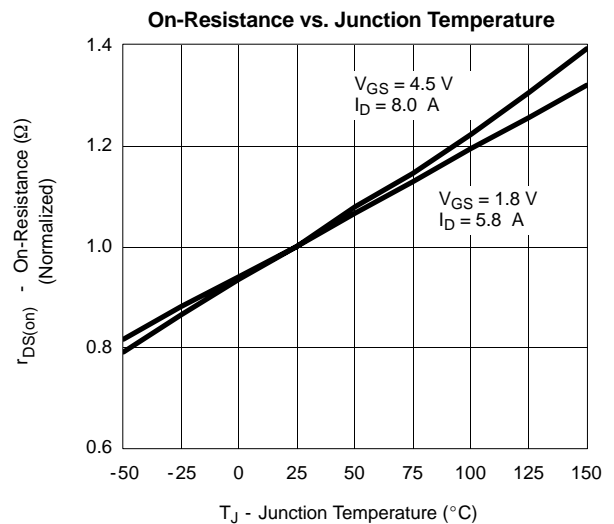
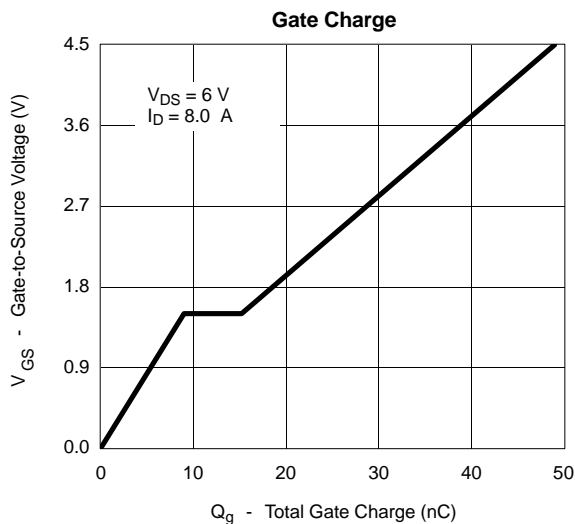
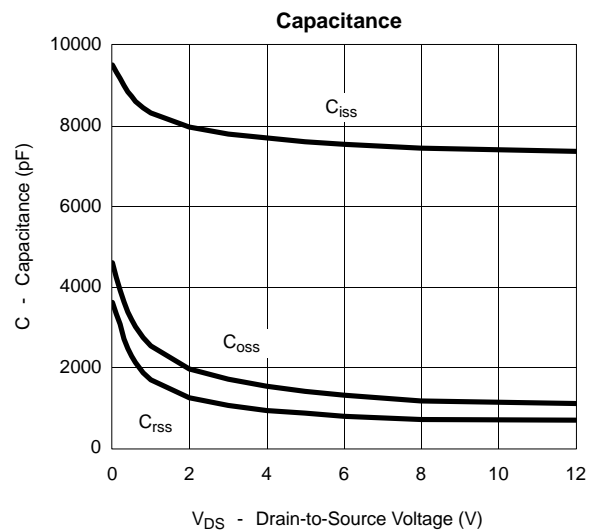
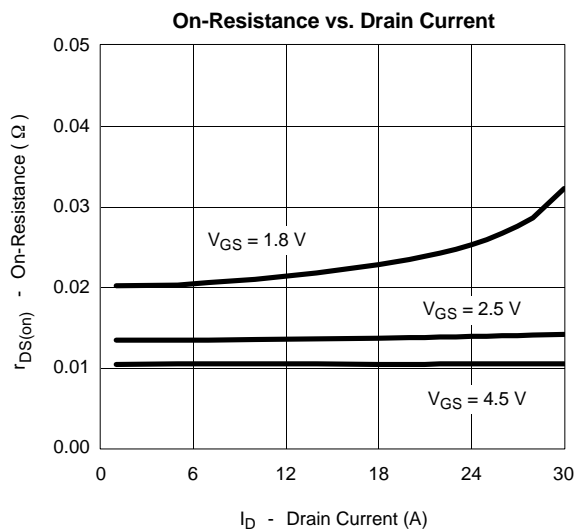
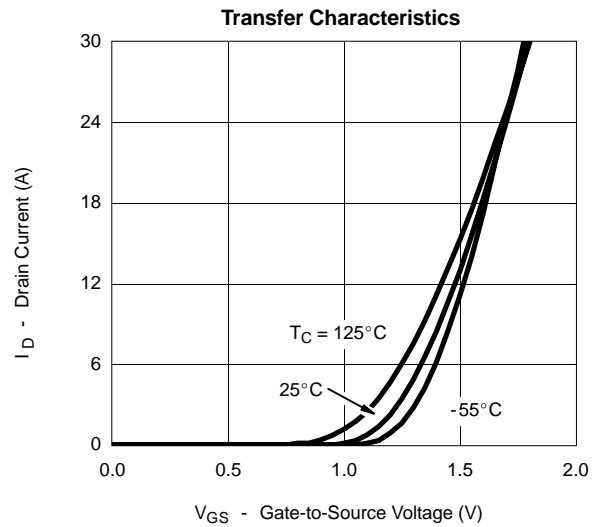
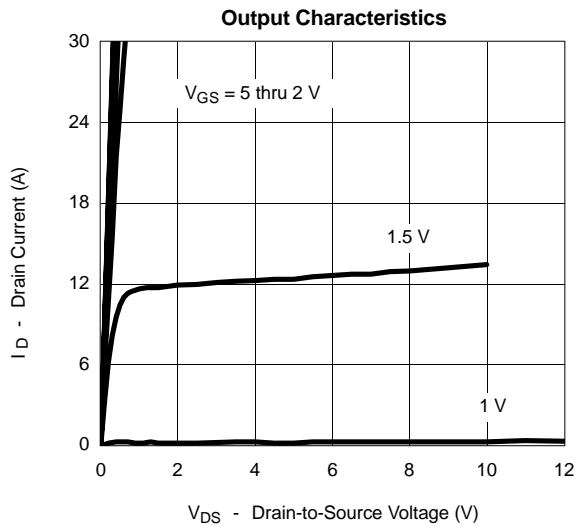

TYPICAL CHARACTERISTICS (25°C UNLESS NOTED)

