

**Buck chopper
Fast Trench + Field Stop IGBT®
Power Module**

**$V_{CES} = 1200V$
 $I_C = 100A @ T_c = 80^\circ C$**

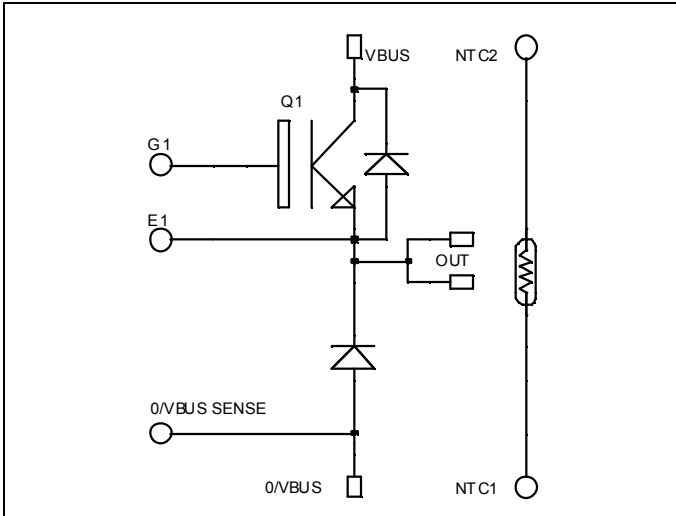

Application

- AC and DC motor control
- Switched Mode Power Supplies

Features

- Fast Trench + Field Stop IGBT® Technology
 - Low voltage drop
 - Low tail current
 - Switching frequency up to 20 kHz
 - Soft recovery parallel diodes
 - Low diode VF
 - Low leakage current
 - Avalanche energy rated
 - RBSOA and SCSOA rated
- Kelvin emitter for easy drive
- Very low stray inductance
 - Symmetrical design
 - Lead frames for power connections
- High level of integration
- Internal thermistor for temperature monitoring

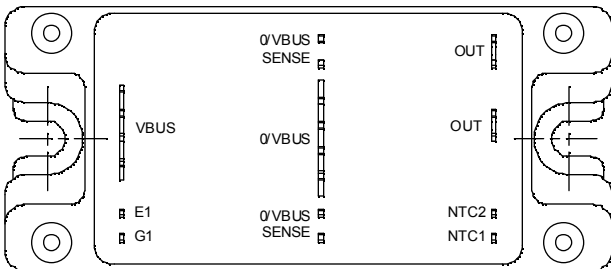

Benefits

- Stable temperature behavior
- Very rugged
- Solderable terminals for easy PCB mounting
- Direct mounting to heatsink (isolated package)
- Low junction to case thermal resistance
- Easy paralleling due to positive TC of VCEsat
- Low profile
- RoHS Compliant

Absolute maximum ratings

Symbol	Parameter	Max ratings	Unit
V_{CES}	Collector - Emitter Breakdown Voltage	1200	V
I_C	Continuous Collector Current	$T_c = 25^\circ C$	140
		$T_c = 80^\circ C$	100
I_{CM}	Pulsed Collector Current	$T_c = 25^\circ C$	200
V_{GE}	Gate - Emitter Voltage	± 20	V
P_D	Maximum Power Dissipation	$T_c = 25^\circ C$	480
RBSOA	Reverse Bias Safe Operating Area	$T_j = 125^\circ C$	200A @ 1100V

CAUTION: These Devices are sensitive to Electrostatic Discharge. Proper Handling Procedures Should Be Followed. See application note APT0502 on www.microsemi.com

All ratings @ $T_j = 25^\circ\text{C}$ unless otherwise specified

Electrical Characteristics

Symbol	Characteristic	Test Conditions	Min	Typ	Max	Unit
I_{CES}	Zero Gate Voltage Collector Current	$V_{GE} = 0\text{V}$, $V_{CE} = 1200\text{V}$			250	μA
$V_{CE(sat)}$	Collector Emitter Saturation Voltage	$V_{GE} = 15\text{V}$ $I_C = 100\text{A}$	$T_j = 25^\circ\text{C}$ 1.4	$T_j = 25^\circ\text{C}$ 1.7	$T_j = 25^\circ\text{C}$ 2.1	V
			$T_j = 125^\circ\text{C}$	2.0		
$V_{GE(th)}$	Gate Threshold Voltage	$V_{GE} = V_{CE}$, $I_C = 2\text{mA}$	5.0	5.8	6.5	V
I_{GES}	Gate – Emitter Leakage Current	$V_{GE} = 20\text{V}$, $V_{CE} = 0\text{V}$			400	nA

Dynamic Characteristics

Symbol	Characteristic	Test Conditions	Min	Typ	Max	Unit
C_{ies}	Input Capacitance	$V_{GE} = 0\text{V}$		7200		pF
C_{oes}	Output Capacitance	$V_{CE} = 25\text{V}$		400		
C_{res}	Reverse Transfer Capacitance	$f = 1\text{MHz}$		300		
$T_{d(on)}$	Turn-on Delay Time	Inductive Switching (25°C) $V_{GE} = \pm 15\text{V}$ $V_{Bus} = 600\text{V}$ $I_C = 100\text{A}$ $R_G = 3.9\Omega$		260		ns
T_r	Rise Time			30		
$T_{d(off)}$	Turn-off Delay Time			420		
T_f	Fall Time			70		
$T_{d(on)}$	Turn-on Delay Time	Inductive Switching (125°C) $V_{GE} = \pm 15\text{V}$ $V_{Bus} = 600\text{V}$ $I_C = 100\text{A}$ $R_G = 3.9\Omega$		290		ns
T_r	Rise Time			50		
$T_{d(off)}$	Turn-off Delay Time			520		
T_f	Fall Time			90		
E_{on}	Turn on Energy	$V_{GE} = \pm 15\text{V}$ $V_{Bus} = 600\text{V}$ $I_C = 100\text{A}$ $R_G = 3.9\Omega$	$T_j = 125^\circ\text{C}$	10		mJ
E_{off}	Turn off Energy		$T_j = 125^\circ\text{C}$	10		

Chopper diode ratings and characteristics

Symbol	Characteristic	Test Conditions	Min	Typ	Max	Unit
V_{RRM}	Maximum Peak Repetitive Reverse Voltage		1200			V
I_{RM}	Maximum Reverse Leakage Current	$V_R = 1200\text{V}$			$T_j = 25^\circ\text{C}$ 250 $T_j = 125^\circ\text{C}$ 500	μA
I_F	DC Forward Current			100		A
V_F	Diode Forward Voltage	$I_F = 100\text{A}$ $V_{GE} = 0\text{V}$		$T_j = 25^\circ\text{C}$ 1.6 $T_j = 125^\circ\text{C}$ 1.6	2.1	V
t_{rr}	Reverse Recovery Time	$I_F = 100\text{A}$ $V_R = 600\text{V}$ $di/dt = 2000\text{A}/\mu\text{s}$		$T_j = 25^\circ\text{C}$ 170 $T_j = 125^\circ\text{C}$ 280		ns
Q_{rr}	Reverse Recovery Charge			$T_j = 25^\circ\text{C}$ 9 $T_j = 125^\circ\text{C}$ 18		μC
E_r	Reverse Recovery Energy			$T_j = 25^\circ\text{C}$ 5 $T_j = 125^\circ\text{C}$ 9		mJ

Temperature sensor NTC (see application note APT0406 on www.microsemi.com for more information).

Symbol	Characteristic	Min	Typ	Max	Unit
R ₂₅	Resistance @ 25°C		50		kΩ
B _{25/85}	T ₂₅ = 298.15 K		3952		K

$$R_T = \frac{R_{25}}{\exp\left[B_{25/85}\left(\frac{1}{T_{25}} - \frac{1}{T}\right)\right]}$$

T: Thermistor temperature
 R_T: Thermistor value at T

Thermal and package characteristics

Symbol	Characteristic	Min	Typ	Max	Unit	
R _{thJC}	Junction to Case Thermal Resistance	IGBT		0.26	°C/W	
		Diode		0.48		
V _{ISOL}	RMS Isolation Voltage, any terminal to case t=1 min, I _{isol} <1mA, 50/60Hz	2500			V	
T _J	Operating junction temperature range	-40		150	°C	
T _{STG}	Storage Temperature Range	-40		125		
T _C	Operating Case Temperature	-40		100		
Torque	Mounting torque	To Heatsink	M5	2.5	4.7	N.m
Wt	Package Weight				160	g

SP4 Package outline (dimensions in mm)

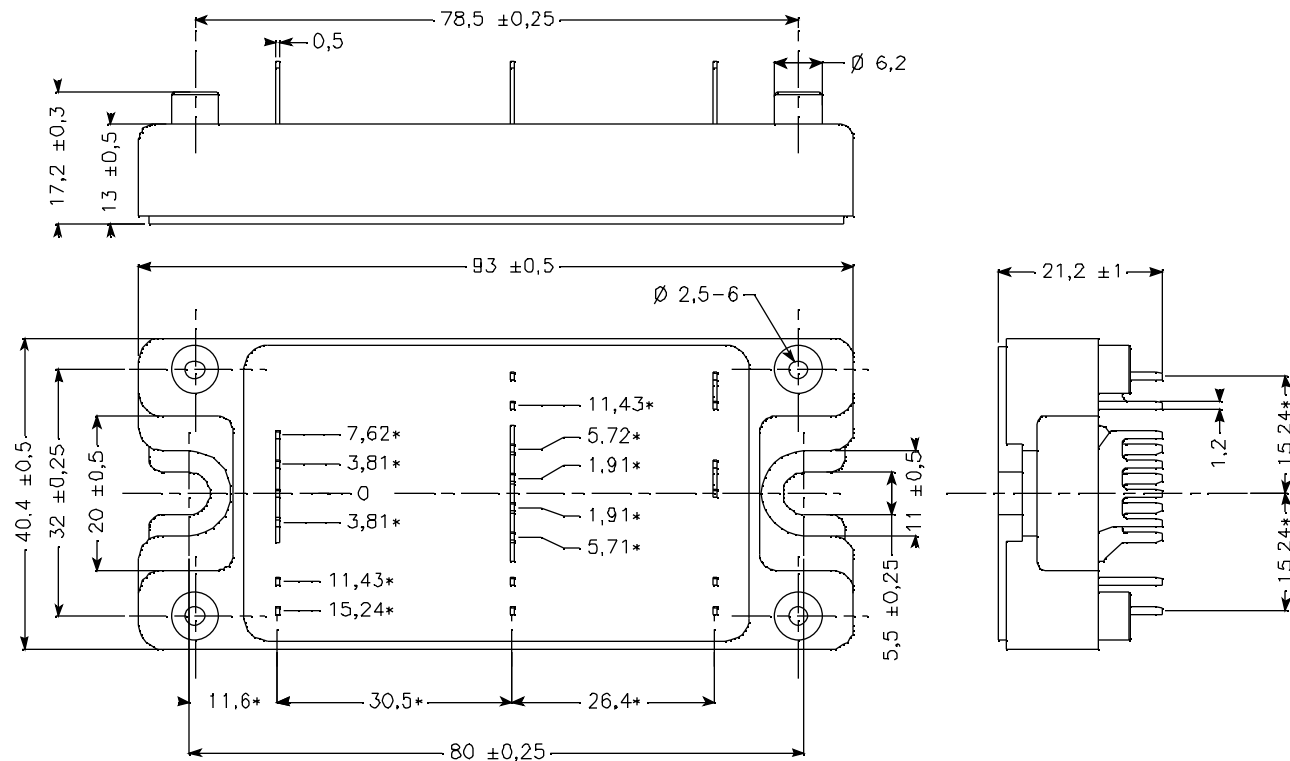

ALL DIMENSIONS MARKED "*" ARE TOLERANCED AS: $\text{Ø} \pm 0.1$

See application note APT0501 - Mounting Instructions for SP4 Power Modules on www.microsemi.com

Typical Performance Curve

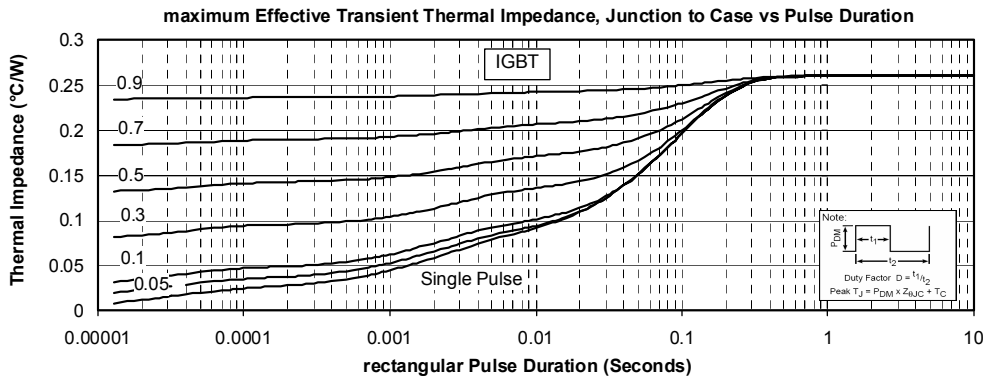
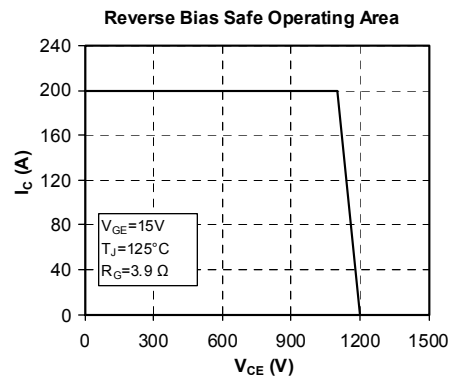
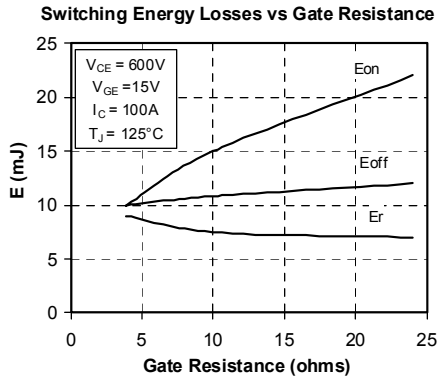
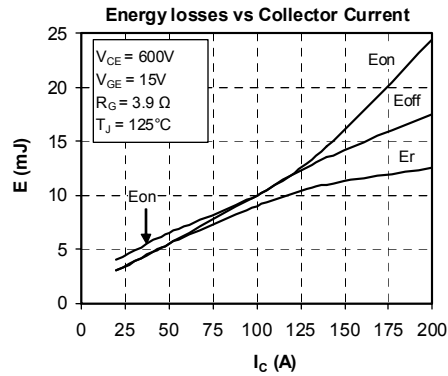
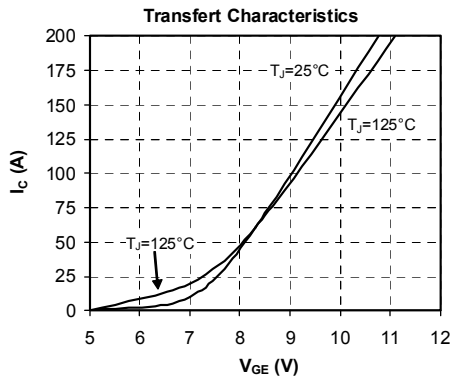
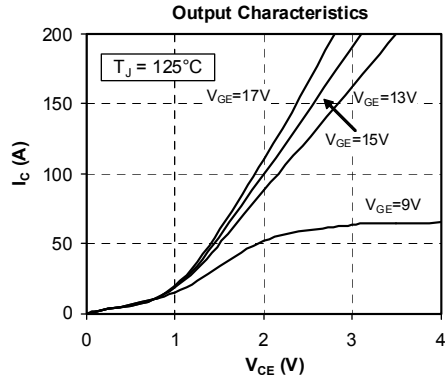
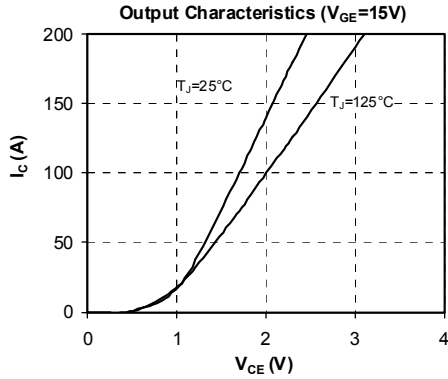

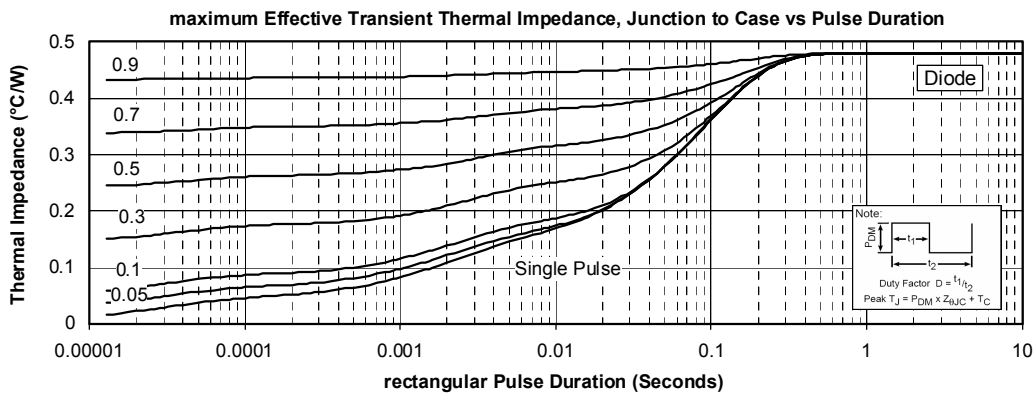
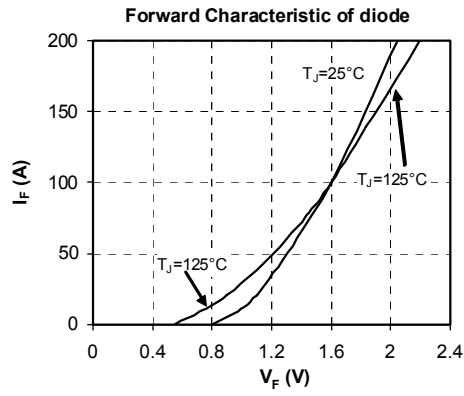
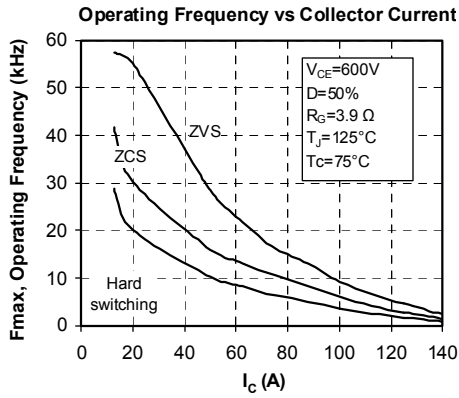

Microsemi reserves the right to change, without notice, the specifications and information contained herein

Microsemi's products are covered by one or more of U.S. patents 4,895,810 5,045,903 5,089,434 5,182,234 5,019,522 5,262,336 6,503,786 5,256,583 4,748,103 5,283,202 5,231,474 5,434,095 5,528,058 and foreign patents. U.S. and Foreign patents pending. All Rights Reserved.