

Adjustable Precision Shunt Regulator

■ Features

- Precision reference voltage
 - CP432 : $1.24V \pm 1\%$
 - CP432A : $1.24V \pm 0.5\%$
- Sink current capability: 200mA.
- Minimum cathode current for regulation: $150\mu A$
- Equivalent full-range temp coefficient: $30 \text{ ppm}/^\circ C$
- Fast turn-on Response.
- Low dynamic output impedance: 0.2Ω
- Programmable output voltage to 20v
- Low output noise
- Packages: SOT89, SOT23, TO92

■ General Description

The CP432/432A are 3-terminal adjustable precision shunt regulators with guaranteed stable temperature over the applicable extended commercial temperature range. The output voltage may be set at any level greater than $1.24V (V_{REF})$ up to 20V merely by selecting two external resistors that act as a voltage divider network. These devices have a typical output impedance of 0.2Ω . Active output circuitry provides very sharp turn-on characteristics, making these devices excellent improved replacements for Zener diodes in many applications.

The precise $\pm 1\%$ reference voltage tolerance of the CP432/432A make it possible in many applications to avoid the use of a variable resistor, consequently saving cost and eliminating drift and reliability problems associated with it.

■ Typical Application Circuit

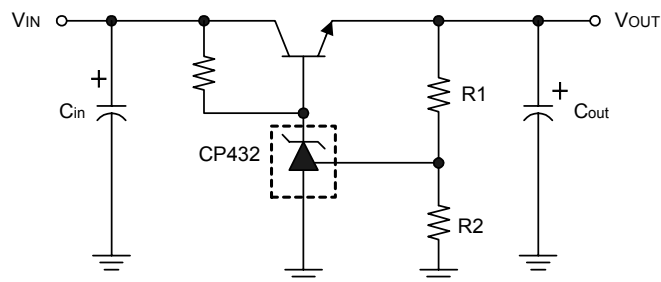

$$V_{OUT} = (1 + R1/R2)V_{REF}$$

Precision Regulator

* All specs and applications shown above subject to change without prior notice.

Adjustable Precision Shunt Regulator

■ Block Diagram

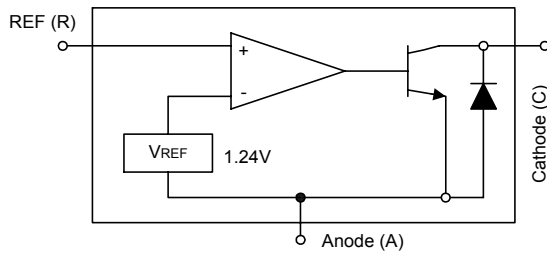

■ Symbol

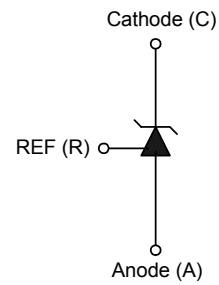

■ Pin Configuration

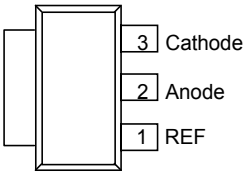
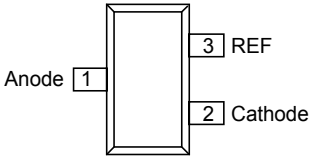
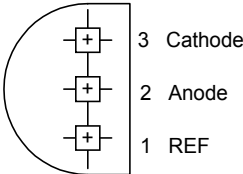
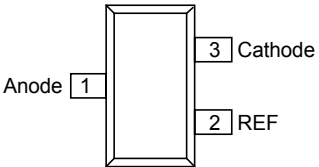
Order Number	Pin Configuration (Top View)	Order Number	Pin Configuration (Top View)
CP432Y CP432AY (SOT89)		CP432R CP432AR (SOT23)	
CP432V CP432AV (TO92)		CP432W CP432AW (SOT23)	

* All specs and applications shown above subject to change without prior notice.

Adjustable Precision Shunt Regulator

■ Absolute Maximum Ratings

	Cathode
voltage	20V
Continuous cathode current	-10mA ~ 250mA
Reference input current range	10mA
Operating temperature range (CP432)	-20°C ~ 85°C
(CP432I).....	-40°C~85°C
Lead Temperature.....	260°C
Storage Temperature	-65°C ~ 150°C
Power Dissipation (Notes 1. 2)	SOT89
	0. 80W
	TO92
	0.78W
	SOT23
	0.23W

Note 1: T_J, max =150°C. .

Note 2: Ratings apply to ambient temperature at 25°C.

■ Electrical Characteristics (Ta=25°C, unless otherwise specified.)

Parameter	Test conditions	Symbol	Min.	Typ.	Max.	Unit
Reference voltage	V _{KA} = V _{ref} , I _{KA} = 10mA (Fig.1)	CP432	1.227	1.24	1.252	V
		CP432A	1.233		1.246	
Deviation of reference input voltage over temperature (Note 3)	V _{KA} = V _{REF} , I _{KA} = 10mA, Ta = full range (Fig.1)	V _{REF}		3.0	20	mV
Ratio of the change in reference voltage to the change in cathode voltage	I _{KA} = 10mA (Fig.2)	V _{KA} = 20 ~V _{REF} $\frac{\Delta V_{REF}}{\Delta V_{KA}}$		-1.4	-2.0	mV/V
Reference input current	R1 = 10KΩ, R2 = ∞ I _{KA} = 10mA (Fig.2)	I _{REF}		1.4	3.5	μA
Deviation of reference input current over temperature	R1 = 10KΩ, R2 = ∞ I _{KA} = 10mA Ta = Full range (Fig.2)	αI _{REF}		0.4	1.2	μA
Minimum cathode current for regulation	V _{KA} = V _{REF} (Fig.1)	I _{KA(min)}		0.15	0.3	mA
Off-state current	V _{KA} = 20V, V _{REF} = 0V (Fig.3)	I _{KA(off)}		0.1	1.0	μA
Dynamic output impedance (Note 4)	V _{KA} = V _{REF} ΔI _{KA} = 0.1mA ~ 15mA Frequency ≤ 1KHz (Fig.1)	Z _{KA}		0.2	0.5	Ω

* All specs and applications shown above subject to change without prior notice.

Adjustable Precision Shunt Regulator

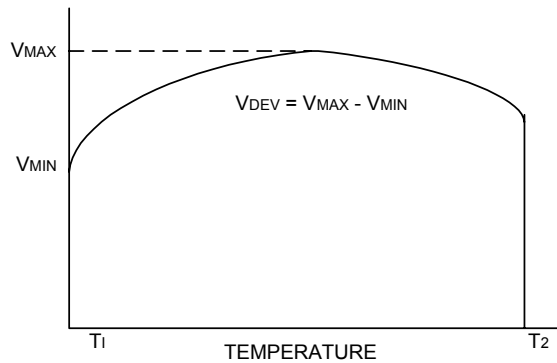

Note 3. Deviation of reference input voltage, V_{DEV} , is defined as the maximum variation of the reference over the full temperature range.

The average temperature coefficient of the reference input voltage αV_{REF} is defined as:

$$|\alpha V_{REF}| = \frac{\left(\frac{V_{DEV}}{V_{REF(25^\circ C)}}\right) \times 10^6}{T_2 - T_1} \dots\dots\dots (\text{ppm}/^\circ\text{C})$$

Where:

$T_2 - T_1$ = full temperature change.

αV_{REF} can be positive or negative depending on whether the slope is positive or negative.

Note 4. The dynamic output impedance, R_Z , is defined as:

$$|Z_{KA}| = \frac{\Delta V_{KA}}{\Delta I_{KA}}$$

When the device is programmed with two external resistors R_1 and R_2 (see Figure 2.), the dynamic output impedance of the overall circuit, is defined as:

$$|Z_{KA}'| = \frac{\Delta V}{\Delta I} \approx |Z_{KA}| \left(1 + \frac{R_1}{R_2}\right)$$

■ Test Circuits

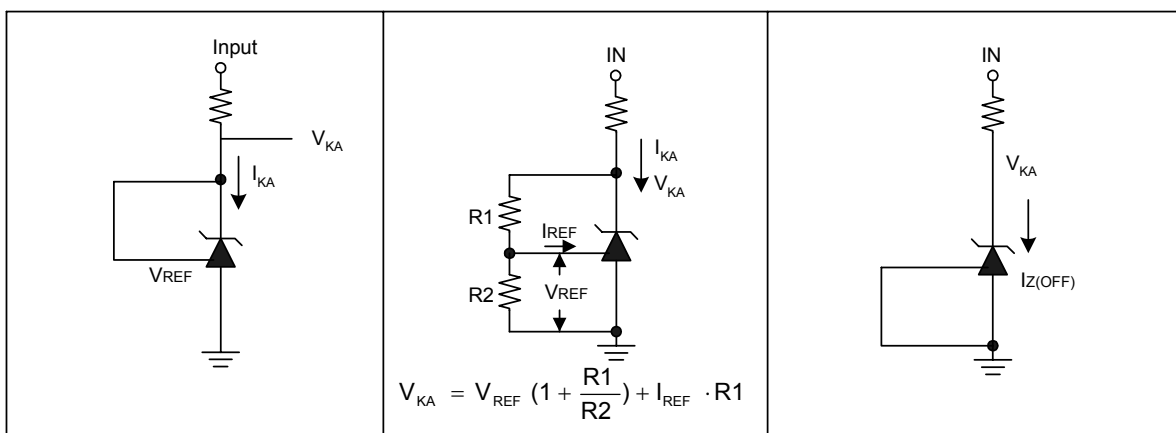

Fig1. Test Circuit for $V_{KA} = V_{REF}$

Fig2. Test circuit for $V_{KA} > V_{REF}$

Fig3. Test Circuit for off-state Current

* All specs and applications shown above subject to change without prior notice.

Adjustable Precision Shunt Regulator

Typical Performance Characteristics

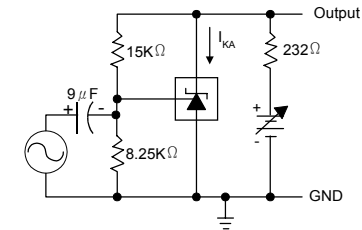
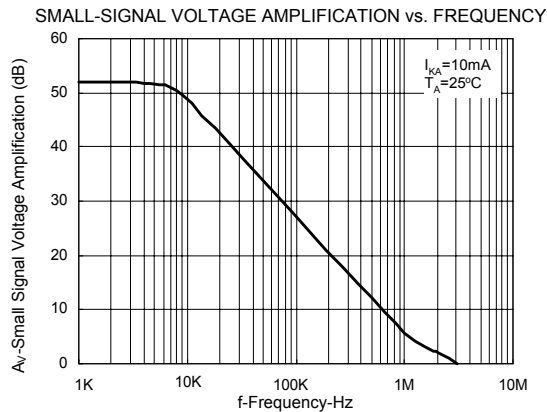

TEST CIRCUIT FOR VOLTAGE AMPLIFICATION

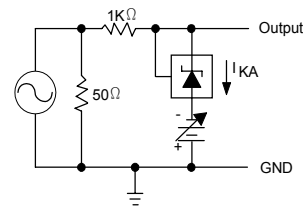
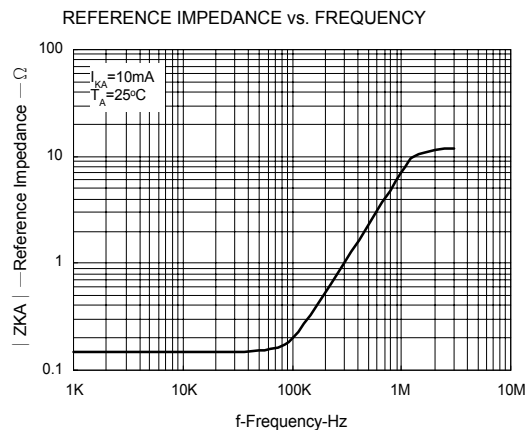

TEST CIRCUIT FOR REFERENCE IMPEDANCE

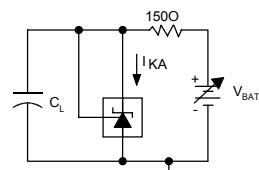
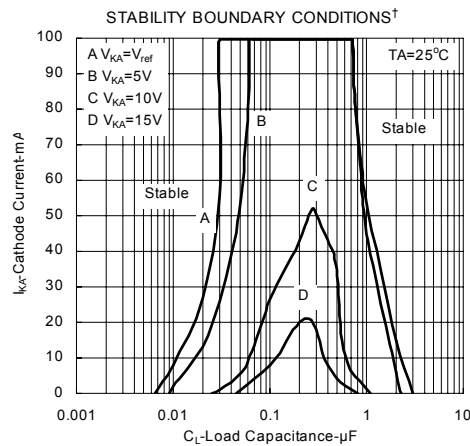

TEST CIRCUIT FOR CURVE A

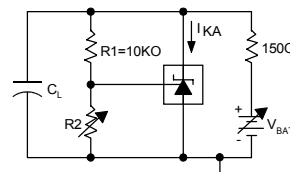

TEST CIRCUIT FOR CURVE B, C, AND D

† The areas under the curves represent conditions that may cause the device to oscillate. For curves B, C, and D, R2 and V+ were adjusted to establish the initial V_{KA} and I_{KA} conditions with $C_L=0$, V_{BATT} and C_L were then adjusted to determine the ranges of stability.

* All specs and applications shown above subject to change without prior notice.

Adjustable Precision Shunt Regulator

Application Examples

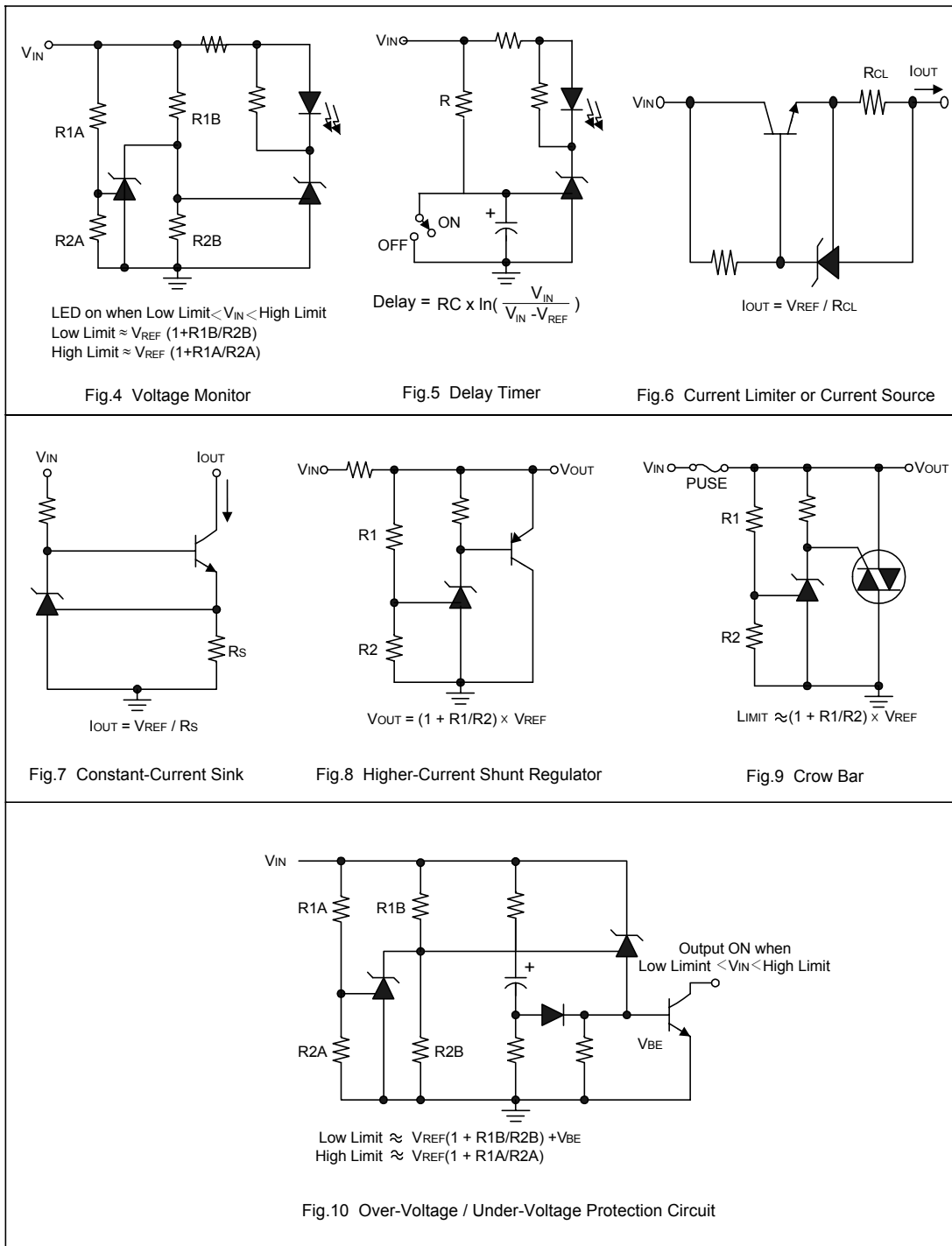

* All specs and applications shown above subject to change without prior notice.

Adjustable Precision Shunt Regulator

■ Package Diagrams

(1) SOT89-3L Package Outline Dimension

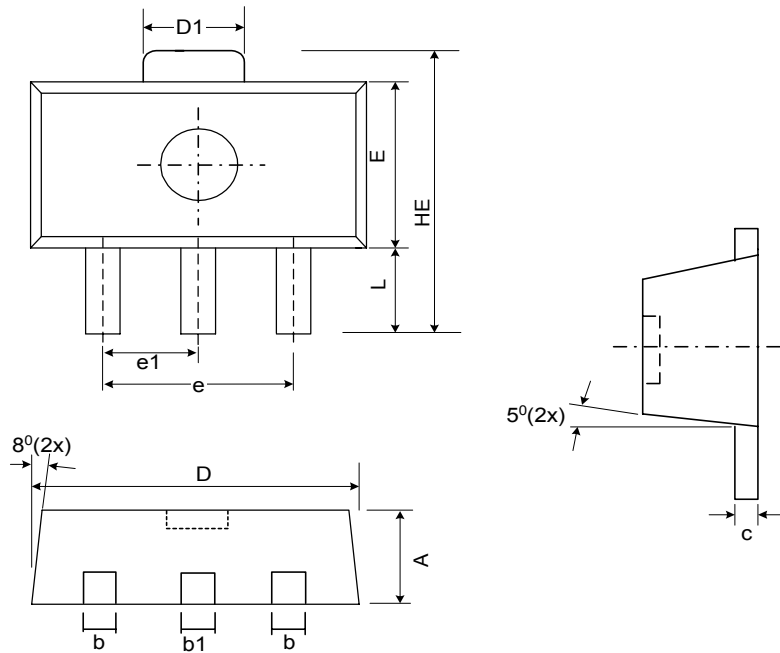

Symbol	Dimensions In Millimeters			Dimensions In Inches		
	Min.	Nom.	Max.	Min.	Nom.	Max.
A	1.40	1.50	1.60	0.055	0.059	0.063
b	0.36	0.42	0.48	0.014	0.016	0.018
b1	0.41	0.47	0.53	0.016	0.043	0.051
C	0.35	0.39	0.43	0.014	0.015	0.017
D	4.40	4.50	4.60	0.173	0.177	0.181
D1	1.40	1.60	1.75	0.055	0.062	0.069
e	2.90	3.00	3.10	0.114	0.118	0.122
e1	1.45	1.50	1.55	0.057	0.059	0.061
E	2.40	2.50	2.60	0.094	0.098	0.102
HE	3.94	-	4.25	0.155	-	0.167
L	0.80	-	1.20	0.031	-	0.047

* All specs and applications shown above subject to change without prior notice.

Adjustable Precision Shunt Regulator

(2) TO92-3L Package Outline Dimension

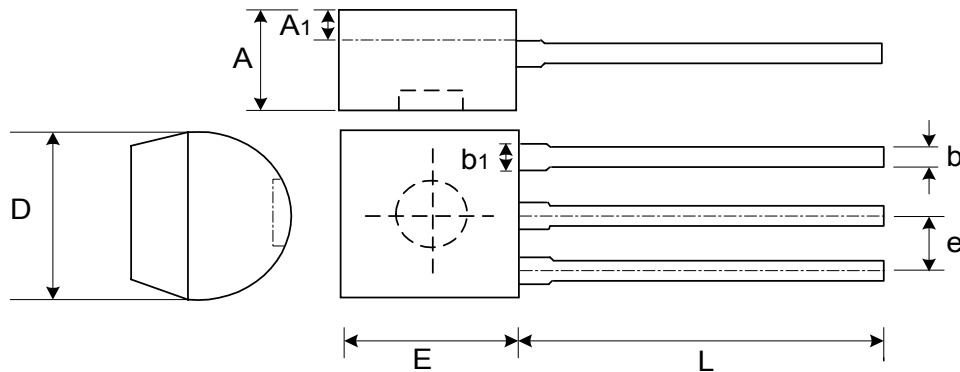

Symbol	Dimensions In Millimeters			Dimensions In Inches		
	Min.	Nom.	Max.	Min.	Nom.	Max.
A	3.302	3.556	3.810	0.130	0.140	0.150
A1	1.016	-	-	0.040	-	-
b	0.330	0.381	0.432	0.013	0.015	0.017
b1	0.406	0.457	0.506	0.016	0.018	0.020
D	4.445	4.572	4.699	0.175	0.180	0.185
E	4.445	4.572	4.699	0.175	0.180	0.185
L	13.00	-	15.500	0.512	-	0.610
e	1.150	1.270	1.390	0.045	0.050	0.055

* All specs and applications shown above subject to change without prior notice.

Adjustable Precision Shunt Regulator

(4) SOT23-3L Package Outline Dimension

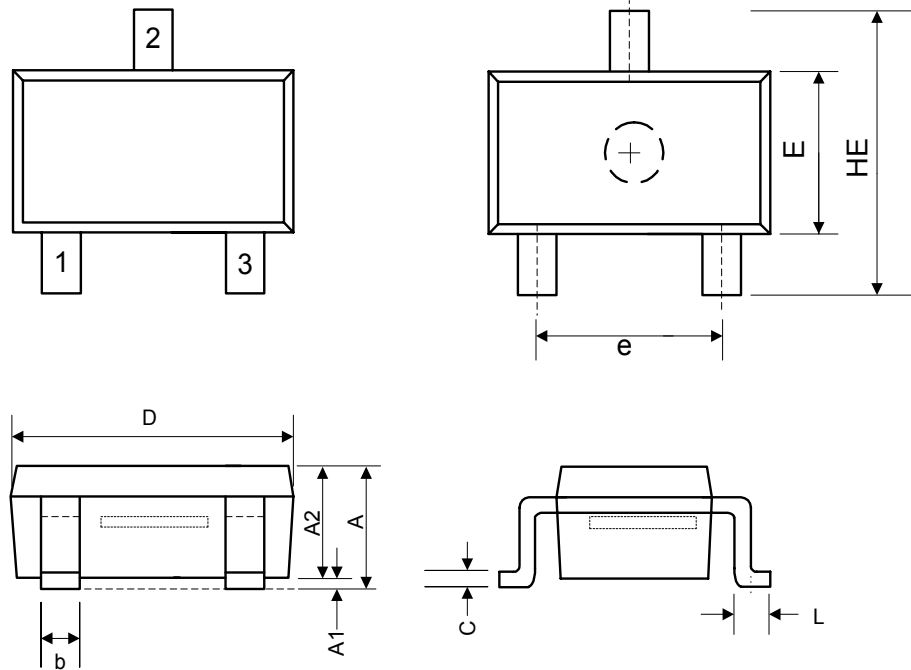

Symbol	Dimensions In Millimeters			Dimensions In Inches		
	Min.	Nom.	Max.	Min.	Nom.	Max.
A	1.00	1.20	1.40	0.039	0.047	0.055
A1	0.00	-	0.10	0.000	-	0.004
A2	1.00	1.15	1.30	0.039	0.045	0.051
b	0.35	-	0.50	0.014	-	0.020
C	0.10	0.175	0.25	0.004	0.007	0.010
D	2.70	2.90	3.10	0.106	0.114	0.122
E	1.40	1.60	1.80	0.055	0.063	0.071
e	1.70	2.00	2.30	0.067	0.079	0.091
HE	2.40	2.70	3.00	0.094	0.106	0.118
L	0.35	0.45	0.55	0.014	0.018	0.022

* All specs and applications shown above subject to change without prior notice.

Adjustable Precision Shunt Regulator

Taping Specifications For TO-92 package

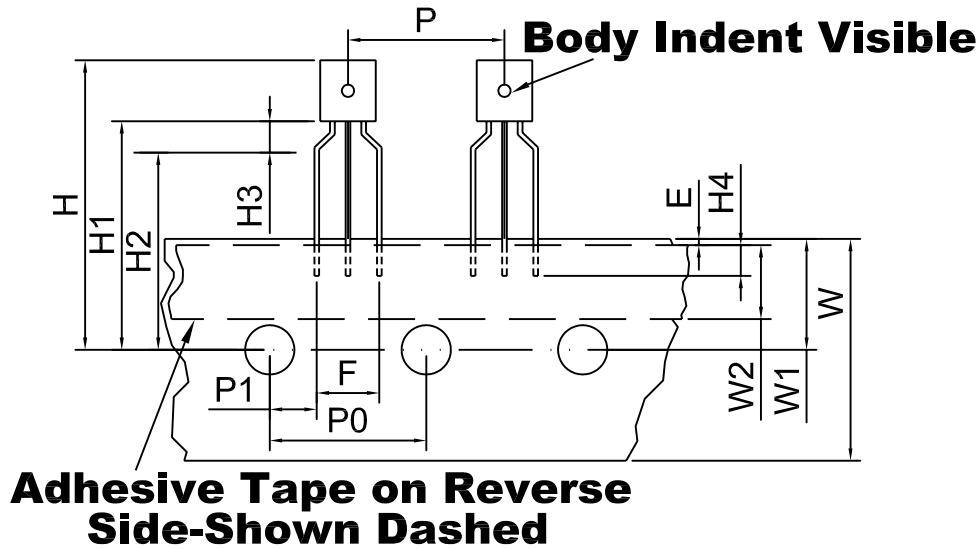

SYMBOL	SPECIFICATIONS (mm)	SPECIFICATIONS (inch)
P	12.7 ± 1.0	0.50 ± 0.07
P0	12.7 ± 1.0	0.50 ± 0.07
P1	3.81 ± 0.4	0.15 ± 0.016
H	21.0~26.0	0.828~1.024
H1	17.0~21.0	0.669~0.828
H2	14.0~18.0	0.551~0.709
H3	3.4 max.	0.125 max.
H4	2.5 min.	0.098 min.
F	5.08 ± 0.2	0.2 ± 0.008
W	18.0 ± 0.5	0.708 ± 0.020
W1	9.0 ± 0.5	0.354 ± 0.020
W2	6.0 ± 0.5	0.236 ± 0.020
ΦD0	4.0 ± 0.2	0.157 ± 0.008
E	0.5 max.	0.020 max.

* All specs and applications shown above subject to change without prior notice.