

*Advance Information*  
**ISOTOP™ TMOS E-FET™**  
**Power Field Effect Transistor**  
**N-Channel Enhancement-Mode Silicon Gate**

This advanced TMOS E-FET is designed to withstand high energy in the avalanche mode and switch efficiently. This new energy design also offers a drain-to-source diode with fast recovery time. Designed for high voltage, high speed switching applications in power supplies, PWM motor controls, and other inductive loads. The avalanche energy capability is specified to eliminate the guesswork in designs where inductive loads are switched and offer additional safety margin against unexpected voltage transients.

- 2500 V RMS Isolated ISOTOP Package
- Avalanche Energy Specified
- Source-to-Drain Diode Recovery Time Comparable to a Discrete Fast Recovery Diode
- Diode is Characterized for Use in Bridge Circuits
- Very Low Internal Parasitic Inductance
- $I_{DSS}$  and  $V_{DS(on)}$  Specified at Elevated Temperature
- U.L. Recognized, File #E69369

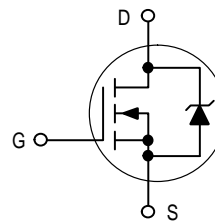

**MTE30N50E**  
Motorola Preferred Device

**TMOS POWER FET**  
**30 AMPERES**  
**500 VOLTS**  
 **$R_{DS(on)} = 0.150 \text{ OHM}$**

**SOT-227B**

1. Source
2. Gate
3. Drain
4. Source 2

**MAXIMUM RATINGS** ( $T_C = 25^\circ\text{C}$  unless otherwise noted)

Rating	Symbol	Value	Unit
Drain-to-Source Voltage	$V_{DSS}$	500	Vdc
Drain-to-Gate Voltage ( $R_{GS} = 1.0 \text{ M}\Omega$ )	$V_{DGR}$	500	Vdc
Gate-to-Source Voltage — Continuous	$V_{GS}$	$\pm 20$	Vdc
— Non-Repetitive ( $t_p \leq 10 \text{ ms}$ )	$V_{GSM}$	$\pm 40$	Vpk
Drain Current — Continuous @ $25^\circ\text{C}$	$I_D$	30	Adc
— Continuous @ $100^\circ\text{C}$	$I_D$	12	
— Single Pulse ( $t_p \leq 10 \mu\text{s}$ )	$I_{DM}$	80	Apk
Total Power Dissipation @ $25^\circ\text{C}$	$P_D$	250	Watts
Derate above $25^\circ\text{C}$		2.0	$\text{W}/^\circ\text{C}$
Operating and Storage Temperature Range	$T_J, T_{stg}$	-55 to 150	$^\circ\text{C}$
Single Pulse Drain-to-Source Avalanche Energy – Starting $T_J = 25^\circ\text{C}$ ( $V_{DD} = 100 \text{ Vdc}$ , $V_{GS} = 10 \text{ Vdc}$ , Peak $I_L = 30 \text{ Apk}$ , $L = 10 \text{ mH}$ , $R_G = 25 \Omega$ )	$E_{AS}$	3000	mJ
Thermal Resistance — Junction to Case	$R_{\theta JC}$	0.5	$^\circ\text{C}/\text{W}$
— Junction to Ambient	$R_{\theta JA}$	62.5	
Maximum Lead Temperature for Soldering Purposes, 1/8" from case for 10 seconds	$T_L$	260	$^\circ\text{C}$

This document contains information on a new product. Specifications and information herein are subject to change without notice.

E-FET is a trademark of Motorola, Inc. TMOS is a registered trademark of Motorola, Inc. ISOTOP is a trademark of SGS-THOMSON Microelectronics.

**Preferred** devices are Motorola recommended choices for future use and best overall value.

# MTE30N50E

## ELECTRICAL CHARACTERISTICS (T<sub>J</sub> = 25°C unless otherwise noted)

Characteristic	Symbol	Min	Typ	Max	Unit
Drain-to-Source Breakdown Voltage (V <sub>GS</sub> = 0 Vdc, I <sub>D</sub> = 0.25 mAdc) Temperature Coefficient (Positive)	V <sub>(BR)DSS</sub>	500 —	560 566	— —	Vdc mV/°C
Zero Gate Voltage Drain Current (V <sub>DS</sub> = 500 Vdc, V <sub>GS</sub> = 0 Vdc) (V <sub>DS</sub> = 500 Vdc, V <sub>GS</sub> = 0 Vdc, T <sub>J</sub> = 125°C)	I <sub>DSS</sub>	— —	— —	10 200	μAdc
Gate-Body Leakage Current (V <sub>GS</sub> = ± 20 Vdc, V <sub>DS</sub> = 0)	I <sub>GSS</sub>	—	—	100	nAdc

### ON CHARACTERISTICS (1)

Gate Threshold Voltage (V <sub>DS</sub> = V <sub>GS</sub> , I <sub>D</sub> = 250 μAdc) Threshold Temperature Coefficient (Negative)	V <sub>GS(th)</sub>	2.0 —	3.2 7.0	4.0 —	Vdc mV/°C
Static Drain-to-Source On-Resistance (V <sub>GS</sub> = 10 Vdc, I <sub>D</sub> = 15 Adc)	R <sub>DS(on)</sub>	—	0.13	0.15	Ohms
Drain-to-Source On-Voltage (V <sub>GS</sub> = 10 Vdc, I <sub>D</sub> = 30 Adc) (V <sub>GS</sub> = 10 Vdc, I <sub>D</sub> = 15 Adc)	V <sub>DS(on)</sub>	— —	4.1 —	5.0 7.0	Vdc
Forward Transconductance (V <sub>DS</sub> = 15 Vdc, I <sub>D</sub> = 15 Adc)	g <sub>FS</sub>	17	—	—	mhos

### DYNAMIC CHARACTERISTICS

Input Capacitance	(V <sub>DS</sub> = 25 Vdc, V <sub>GS</sub> = 0 Vdc, f = 1.0 MHz)	C <sub>iss</sub>	—	7200	10080	pF
Output Capacitance		C <sub>oss</sub>	—	775	1200	
Transfer Capacitance		C <sub>rss</sub>	—	120	250	

### SWITCHING CHARACTERISTICS (2)

Turn-On Delay Time	(V <sub>DD</sub> = 250 Vdc, I <sub>D</sub> = 30 Adc, V <sub>GS</sub> = 10 Vdc, R <sub>G</sub> = 4.7 Ω)	t <sub>d(on)</sub>	—	32	60	ns
Rise Time		t <sub>r</sub>	—	105	175	
Turn-Off Delay Time		t <sub>d(off)</sub>	—	160	275	
Fall Time		t <sub>f</sub>	—	115	200	
Gate Charge (see figure 8)	(V <sub>DS</sub> = 400 Vdc, I <sub>D</sub> = 30 Adc, V <sub>GS</sub> = 10 Vdc)	Q <sub>T</sub>	—	235	350	nC
		Q <sub>1</sub>	—	35	—	
		Q <sub>2</sub>	—	110	—	
		Q <sub>3</sub>	—	65	—	

### SOURCE-DRAIN DIODE CHARACTERISTICS

Forward On-Voltage (I <sub>S</sub> = 30 Adc, V <sub>GS</sub> = 0 Vdc) (I <sub>S</sub> = 30 Adc, V <sub>GS</sub> = 0 Vdc, T <sub>J</sub> = 125°C)	V <sub>SD</sub>	— —	0.95 0.88	1.2 —	Vdc	
Reverse Recovery Time	(I <sub>S</sub> = 30 Adc, V <sub>GS</sub> = 0 Vdc, dI <sub>S</sub> /dt = 100 A/μs)	t <sub>rr</sub>	—	485	—	ns
		t <sub>a</sub>	—	312	—	
		t <sub>b</sub>	—	173	—	
Reverse Recovery Stored Charge	Q <sub>RR</sub>	—	8.2	—	μC	

### INTERNAL PACKAGE INDUCTANCE

Internal Drain Inductance	L <sub>D</sub>	—	5.0	—	nH
Internal Source Inductance	L <sub>S</sub>	—	5.0	—	nH

- (1) Pulse Test: Pulse Width ≤ 300 μs, Duty Cycle ≤ 2%.  
 (2) Switching characteristics are independent of operating junction temperature.

TYPICAL ELECTRICAL CHARACTERISTICS

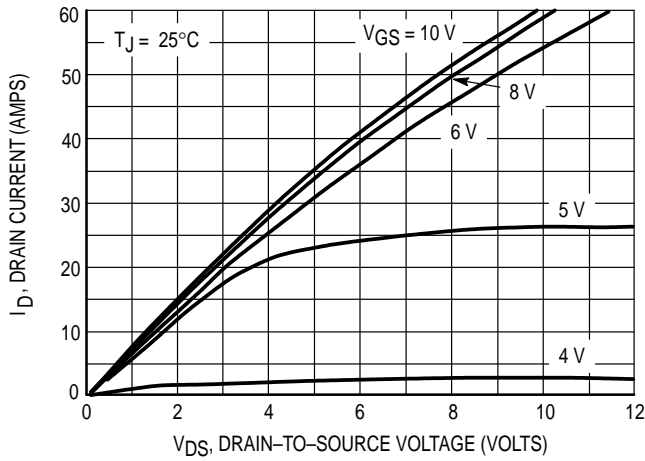

Figure 1. On-Region Characteristics

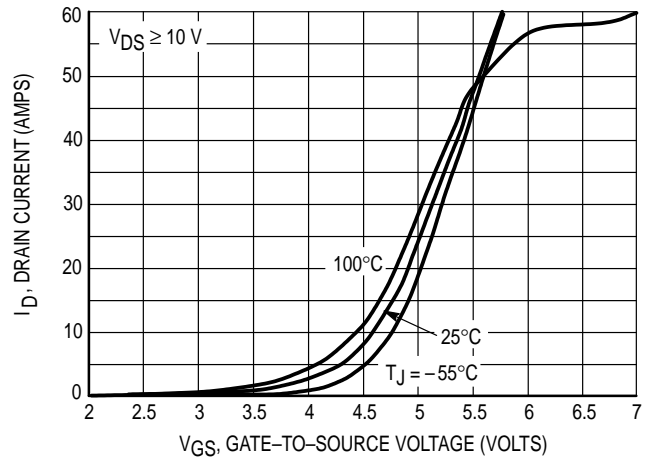

Figure 2. Transfer Characteristics

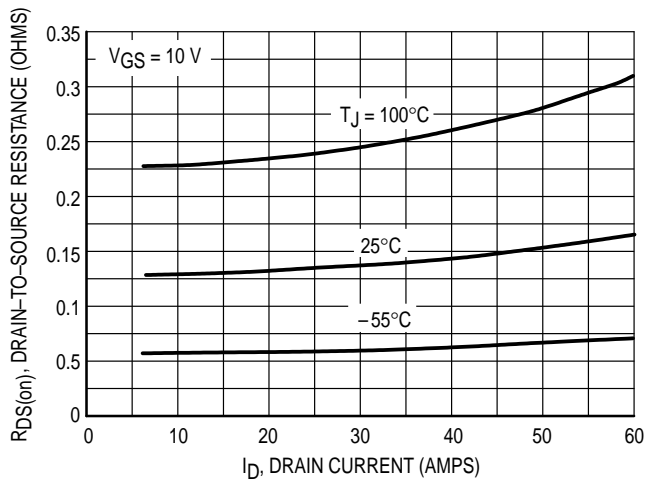

Figure 3. On-Resistance versus Drain Current and Temperature

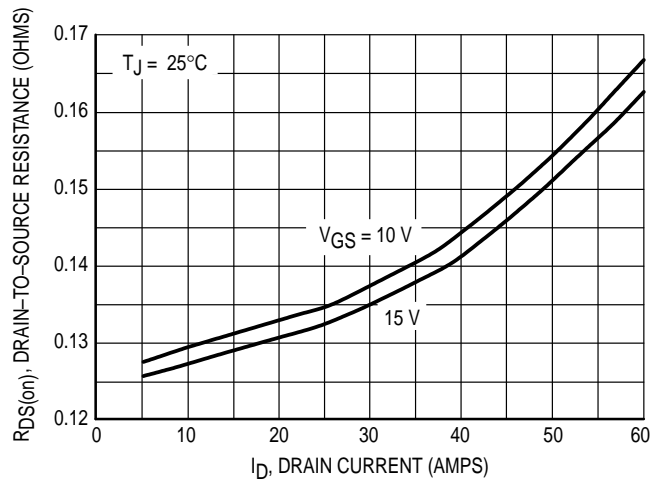

Figure 4. On-Resistance versus Drain Current and Gate Voltage

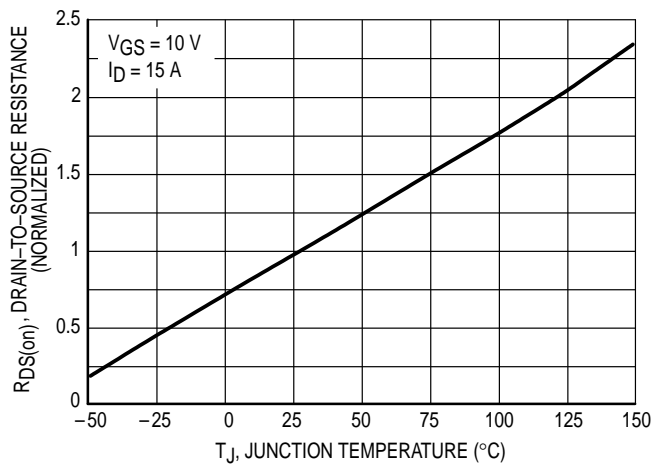

Figure 5. On-Resistance Variation with Temperature

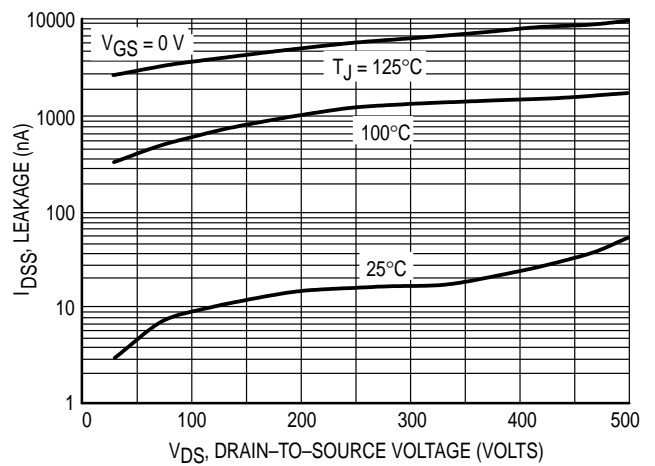

Figure 6. Drain-to-Source Leakage Current versus Voltage

POWER MOSFET SWITCHING

Switching behavior is most easily modeled and predicted by recognizing that the power MOSFET is charge controlled. The lengths of various switching intervals ( $\Delta t$ ) are determined by how fast the FET input capacitance can be charged by current from the generator.

The published capacitance data is difficult to use for calculating rise and fall because drain-gate capacitance varies greatly with applied voltage. Accordingly, gate charge data is used. In most cases, a satisfactory estimate of average input current ( $I_{G(AV)}$ ) can be made from a rudimentary analysis of the drive circuit so that

$$t = Q/I_{G(AV)}$$

During the rise and fall time interval when switching a resistive load,  $V_{GS}$  remains virtually constant at a level known as the plateau voltage,  $V_{SGP}$ . Therefore, rise and fall times may be approximated by the following:

$$t_r = Q_2 \times R_G / (V_{GG} - V_{SGP})$$

$$t_f = Q_2 \times R_G / V_{SGP}$$

where

$V_{GG}$  = the gate drive voltage, which varies from zero to  $V_{GG}$

$R_G$  = the gate drive resistance

and  $Q_2$  and  $V_{SGP}$  are read from the gate charge curve.

During the turn-on and turn-off delay times, gate current is not constant. The simplest calculation uses appropriate values from the capacitance curves in a standard equation for voltage change in an RC network. The equations are:

$$t_{d(on)} = R_G C_{iss} \ln [V_{GG} / (V_{GG} - V_{SGP})]$$

$$t_{d(off)} = R_G C_{iss} \ln (V_{GG} / V_{SGP})$$

The capacitance ( $C_{iss}$ ) is read from the capacitance curve at a voltage corresponding to the off-state condition when calculating  $t_{d(on)}$  and is read at a voltage corresponding to the on-state when calculating  $t_{d(off)}$ .

At high switching speeds, parasitic circuit elements complicate the analysis. The inductance of the MOSFET source lead, inside the package and in the circuit wiring which is common to both the drain and gate current paths, produces a voltage at the source which reduces the gate drive current. The voltage is determined by  $L di/dt$ , but since  $di/dt$  is a function of drain current, the mathematical solution is complex. The MOSFET output capacitance also complicates the mathematics. And finally, MOSFETs have finite internal gate resistance which effectively adds to the resistance of the driving source, but the internal resistance is difficult to measure and, consequently, is not specified.

The resistive switching time variation versus gate resistance (Figure 9) shows how typical switching performance is affected by the parasitic circuit elements. If the parasitics were not present, the slope of the curves would maintain a value of unity regardless of the switching speed. The circuit used to obtain the data is constructed to minimize common inductance in the drain and gate circuit loops and is believed readily achievable with board mounted components. Most power electronic loads are inductive; the data in the figure is taken with a resistive load, which approximates an optimally snubbed inductive load. Power MOSFETs may be safely operated into an inductive load; however, snubbing reduces switching losses.

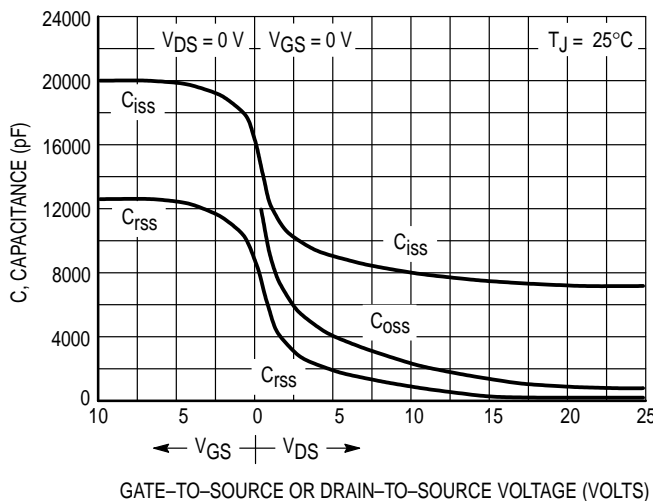

Figure 7. Capacitance Variation

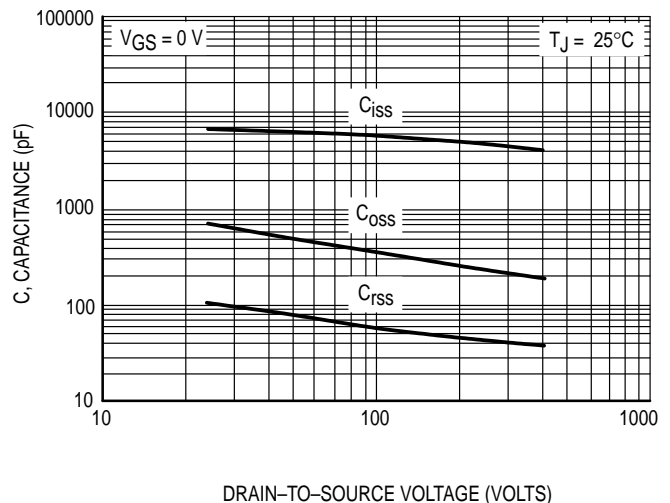
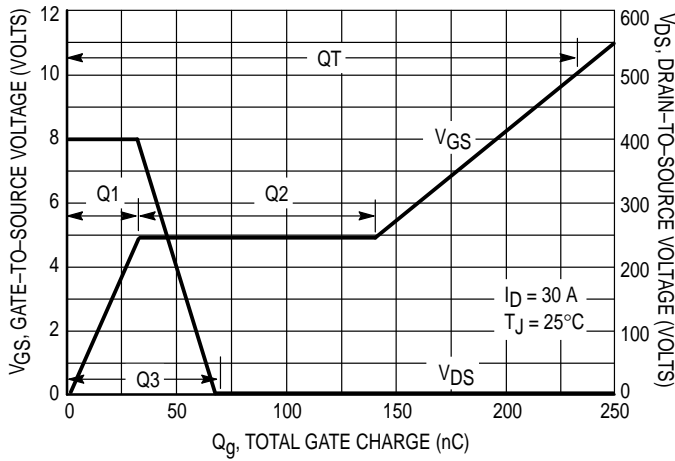
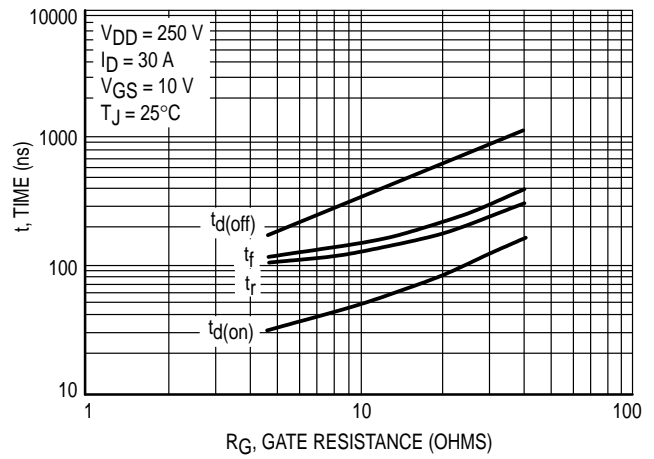

Figure 7b. High Voltage Capacitance Variation



**Figure 8. Gate-To-Source and Drain-To-Source Voltage versus Total Charge**



**Figure 9. Resistive Switching Time Variation versus Gate Resistance**

**SAFE OPERATING AREA**

The Forward Biased Safe Operating Area curves define the maximum simultaneous drain-to-source voltage and drain current that a transistor can handle safely when it is forward biased. Curves are based upon maximum peak junction temperature and a case temperature ( $T_C$ ) of 25°C. Peak repetitive pulsed power limits are determined by using the thermal response data in conjunction with the procedures discussed in AN569, "Transient Thermal Resistance—General Data and Its Use."

Switching between the off-state and the on-state may traverse any load line provided neither rated peak current ( $I_{DM}$ ) nor rated voltage ( $V_{DSS}$ ) is exceeded and the transition time ( $t_r, t_f$ ) do not exceed 10  $\mu s$ . In addition the total power aver-

aged over a complete switching cycle must not exceed  $(T_{J(MAX)} - T_C)/(R_{\theta JC})$ .

A Power MOSFET designated E-FET can be safely used in switching circuits with unclamped inductive loads. For reliable operation, the stored energy from circuit inductance dissipated in the transistor while in avalanche must be less than the rated limit and adjusted for operating conditions differing from those specified. Although industry practice is to rate in terms of energy, avalanche energy capability is not a constant. The energy rating decreases non-linearly with an increase of peak current in avalanche and peak junction temperature.

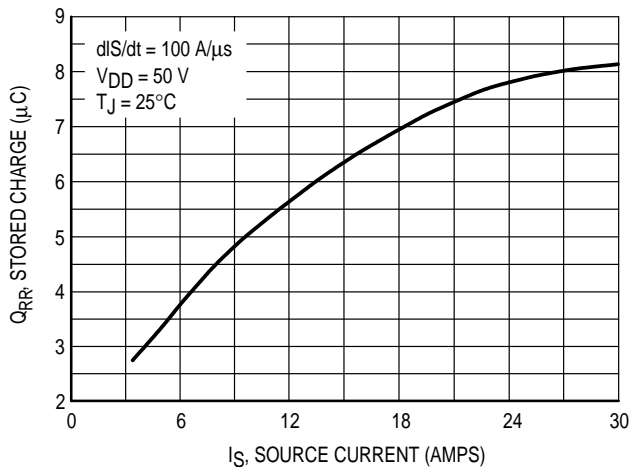

**Figure 10. Stored Charge**

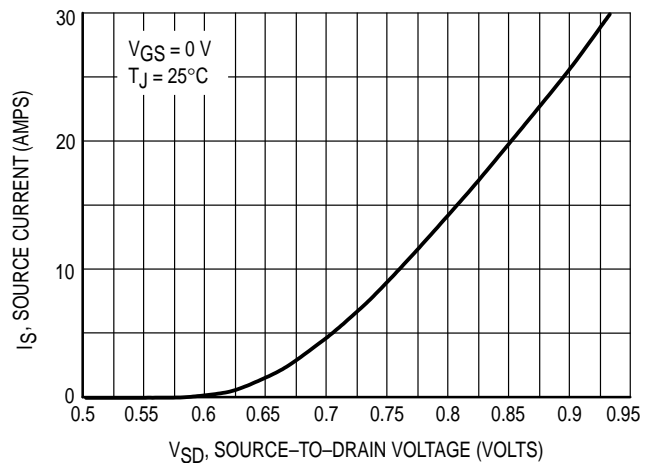

**Figure 11. Diode Forward Voltage versus Current**

SAFE OPERATING AREA

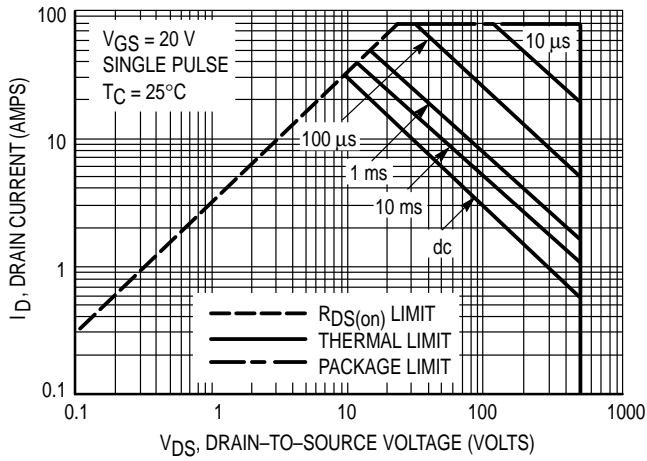

Figure 12. Maximum Rated Forward Biased Safe Operating Area

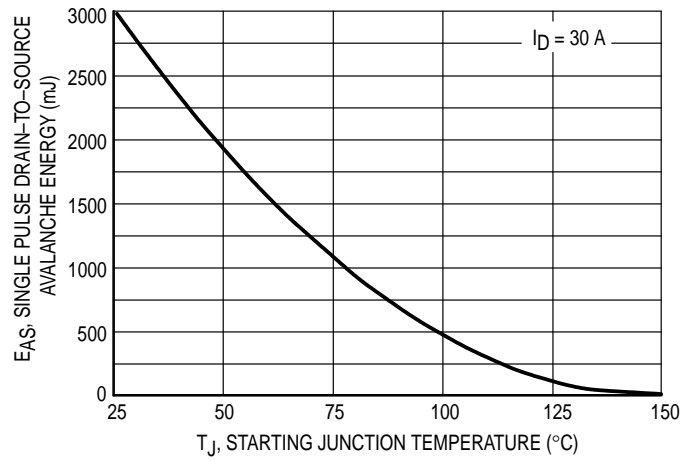

Figure 13. Maximum Avalanche Energy versus Starting Junction Temperature

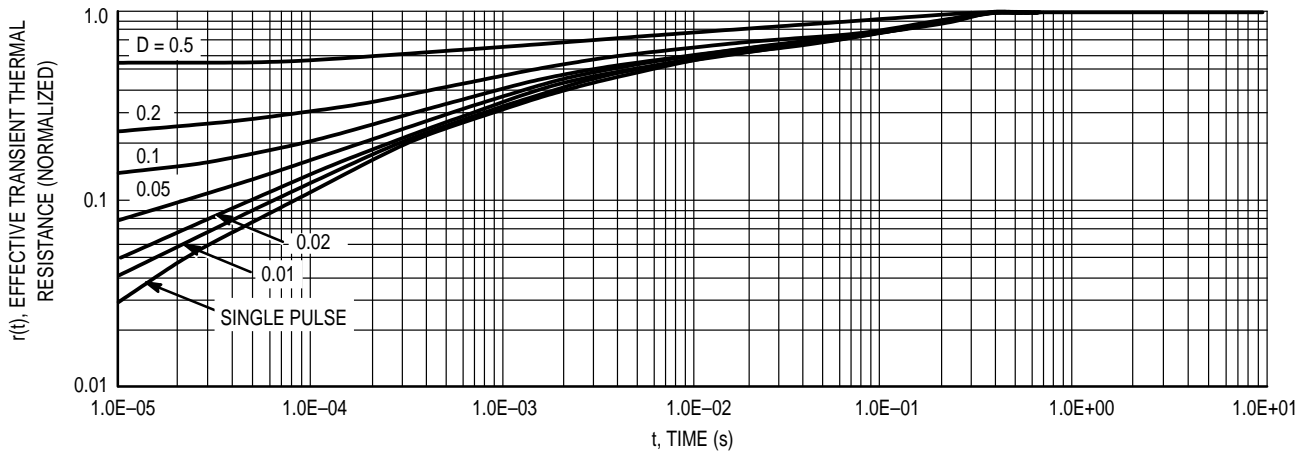

Figure 14. Thermal Response

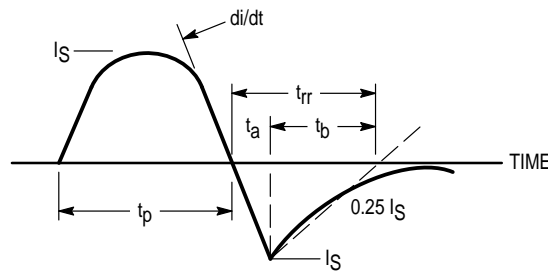
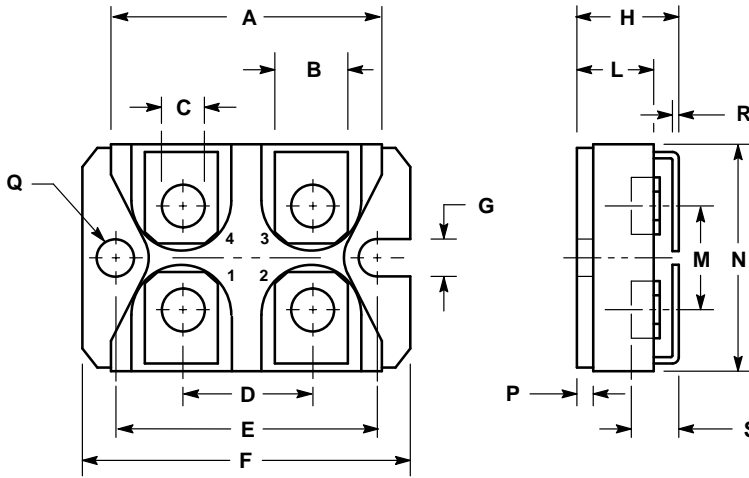

Figure 15. Diode Reverse Recovery Waveform

PACKAGE DIMENSIONS



- NOTES:  
 1. DIMENSIONING AND TOLERANCING PER ANSI Y14.5M, 1982.  
 2. CONTROLLING DIMENSION: MILLIMETERS.

DIM	MILLIMETERS		INCHES	
	MIN	MAX	MIN	MAX
A	31.50	31.70	1.240	1.248
B	7.80	8.20	0.307	0.322
C	4.10	4.30	0.161	0.169
D	14.90	15.10	0.586	0.590
E	30.10	30.30	1.185	1.193
F	38.00	38.20	1.496	1.503
G	4.00	—	0.157	—
H	11.80	12.20	0.464	0.480
L	8.90	9.10	0.350	0.358
M	12.60	12.80	0.496	0.503
N	25.20	25.40	0.992	1.000
P	1.95	2.05	0.076	0.080
Q	4.10	—	0.157	—
R	0.75	0.85	0.030	0.033
S	5.50	—	0.217	—

Recommended screw torque:  $1.3 \pm 0.2$  Nm  
 Maximum screw torque: 1.5 Nm

- STYLE 1:  
 PIN 1. SOURCE  
 2. GATE  
 3. DRAIN  
 4. SOURCE 2

SOT-227B

# MTE30N50E

Motorola reserves the right to make changes without further notice to any products herein. Motorola makes no warranty, representation or guarantee regarding the suitability of its products for any particular purpose, nor does Motorola assume any liability arising out of the application or use of any product or circuit, and specifically disclaims any and all liability, including without limitation consequential or incidental damages. "Typical" parameters can and do vary in different applications. All operating parameters, including "Typicals" must be validated for each customer application by customer's technical experts. Motorola does not convey any license under its patent rights nor the rights of others. Motorola products are not designed, intended, or authorized for use as components in systems intended for surgical implant into the body, or other applications intended to support or sustain life, or for any other application in which the failure of the Motorola product could create a situation where personal injury or death may occur. Should Buyer purchase or use Motorola products for any such unintended or unauthorized application, Buyer shall indemnify and hold Motorola and its officers, employees, subsidiaries, affiliates, and distributors harmless against all claims, costs, damages, and expenses, and reasonable attorney fees arising out of, directly or indirectly, any claim of personal injury or death associated with such unintended or unauthorized use, even if such claim alleges that Motorola was negligent regarding the design or manufacture of the part. Motorola and  are registered trademarks of Motorola, Inc. Motorola, Inc. is an Equal Opportunity/Affirmative Action Employer.

#### How to reach us:

**USA / EUROPE:** Motorola Literature Distribution;  
P.O. Box 20912; Phoenix, Arizona 85036. 1-800-441-2447

**JAPAN:** Nippon Motorola Ltd.; Tatsumi-SPD-JLDC, Toshikatsu Otsuki,  
6F Seibu-Butsuryu-Center, 3-14-2 Tatsumi Koto-Ku, Tokyo 135, Japan. 03-3521-8315

**MFAX:** RMFAX0@email.sps.mot.com - TOUCHTONE (602) 244-6609  
**INTERNET:** <http://Design-NET.com>

**HONG KONG:** Motorola Semiconductors H.K. Ltd.; 8B Tai Ping Industrial Park,  
51 Ting Kok Road, Tai Po, N.T., Hong Kong. 852-26629298



MTE30N50E/D

