

Absolute Maximum Ratings			
Symbol	Conditions <sup>1)</sup>	Values	Units
Inverter & Chopper			
V <sub>CES</sub>		600	V
V <sub>GES</sub>		± 20	V
I <sub>C</sub>	T <sub>heatsink</sub> = 25 / 80 °C	17 / 12	A
I <sub>CM</sub>	t <sub>p</sub> < 1 ms; T <sub>heatsink</sub> = 25 / 80 °C	34 / 24	A
I <sub>F</sub> = -I <sub>C</sub>	T <sub>heatsink</sub> = 25 / 80 °C	20 / 15	A
I <sub>FM</sub> = -I <sub>CM</sub>	t <sub>p</sub> < 1 ms; T <sub>heatsink</sub> = 25 / 80 °C	40 / 30	A
Bridge Rectifier			
V <sub>RRM</sub>		800	V
I <sub>D</sub>	T <sub>heatsink</sub> = 80 °C	12 <sup>3)</sup>	A
I <sub>FSM</sub>	t <sub>p</sub> = 10 ms; sin. 180 °, T <sub>J</sub> = 25 °C	370	A
I <sup>2</sup> t	t <sub>p</sub> = 10 ms; sin. 180 °, T <sub>J</sub> = 25 °C	680	A <sup>2</sup> s
T <sub>J</sub>		- 40 ... + 150	°C
T <sub>stg</sub>		- 40 ... + 125	°C
V <sub>isol</sub>	AC, 1 min.	2500	V

### MiniSKiiP 1 SEMIKRON integrated intelligent Power SKiiP 11 NAB 063 T1

**3-phase bridge rectifier +  
braking chopper +  
3-phase bridge inverter**

Case M1

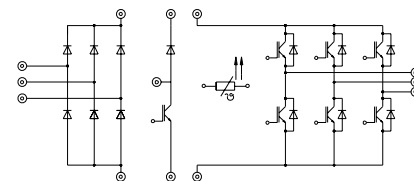
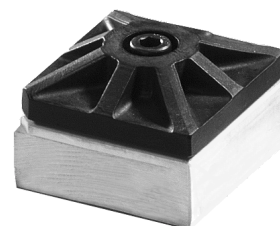

UL recognized file no. E63532

- fast NPT IGBTs

Characteristics					
Symbol	Conditions <sup>1)</sup>	min.	typ.	max.	Units
IGBT - Inverter & Chopper					
V <sub>CEsat</sub>	I <sub>C</sub> = 10 A T <sub>J</sub> = 25 (125) °C	-	2,1(2,4)	2,6(2,9)	V
t <sub>d(on)</sub>	V <sub>CC</sub> = 300 V; V <sub>GE</sub> = ± 15 V	-	55	-	ns
t <sub>r</sub>	I <sub>C</sub> = 10 A; T <sub>J</sub> = 125 °C	-	40	-	ns
t <sub>d(off)</sub>	R <sub>gon</sub> = R <sub>goff</sub> = 100 Ω	-	270	-	ns
t <sub>f</sub>	inductive load	-	25	-	ns
E <sub>on</sub> + E <sub>off</sub>		-	1,0	-	mJ
C <sub>ies</sub>	V <sub>CE</sub> = 25 V; V <sub>GE</sub> = 0 V, 1 MHz	-	0,57	-	nF
R <sub>thjh</sub>	per IGBT	-	-	2,3	K/W
Diode <sup>2)</sup> - Inverter & Chopper					
V <sub>F</sub> = V <sub>EC</sub>	I <sub>F</sub> = 10 A T <sub>J</sub> = 25 (125) °C	-	1,45(1,4)	1,7(1,7)	V
V <sub>TO</sub>	T <sub>J</sub> = 125 °C	-	0,85	0,9	V
r <sub>T</sub>	T <sub>J</sub> = 125 °C	-	55	80	mΩ
I <sub>RRM</sub>	I <sub>F</sub> = 10 A, V <sub>R</sub> = - 300 V	-	6,5	-	A
Q <sub>rr</sub>	di <sub>F</sub> /dt = - 200 A/μs	-	1	-	μC
E <sub>off</sub>	V <sub>GE</sub> = 0 V, T <sub>J</sub> = 125 °C	-	0,1	-	mJ
R <sub>thjh</sub>	per diode	-	-	2,7	K/W
Diode - Rectifier					
V <sub>F</sub>	I <sub>F</sub> = 25 A T <sub>J</sub> = 25 °C	-	1,2	-	V
R <sub>thjh</sub>	per diode	-	-	1,7	K/W
Temperature Sensor					
R <sub>TS</sub>	T = 25 / 100 °C		1000 / 1670		Ω
Mechanical Data					
M <sub>1</sub>	Mounting torque	2	-	2,5	Nm
Case			M1		

<sup>1)</sup> T<sub>heatsink</sub> = 25 °C, unless otherwise specified

<sup>2)</sup> CAL = Controlled Axial Lifetime Technology (soft and fast recovery)

<sup>3)</sup> Limited by spring contact

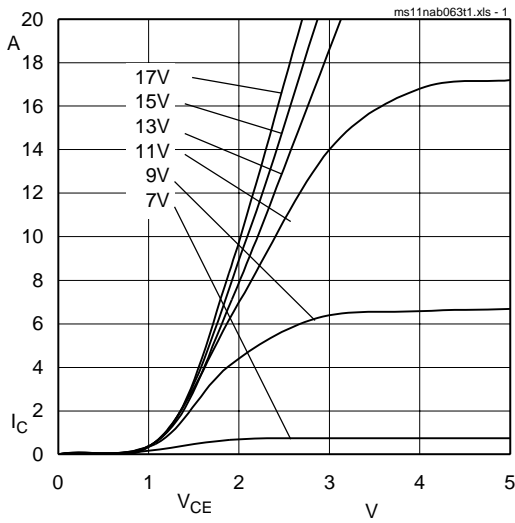

Fig. 1 Typ. output characteristic,  $t_p = 80 \mu s$ ;  $25^\circ C$

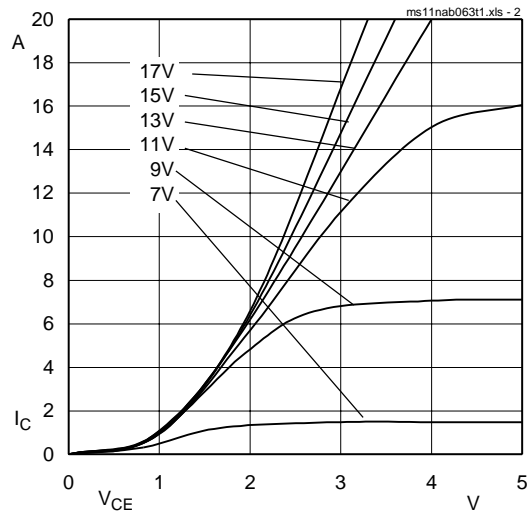

Fig. 2 Typ. output characteristic,  $t_p = 80 \mu s$ ;  $125^\circ C$

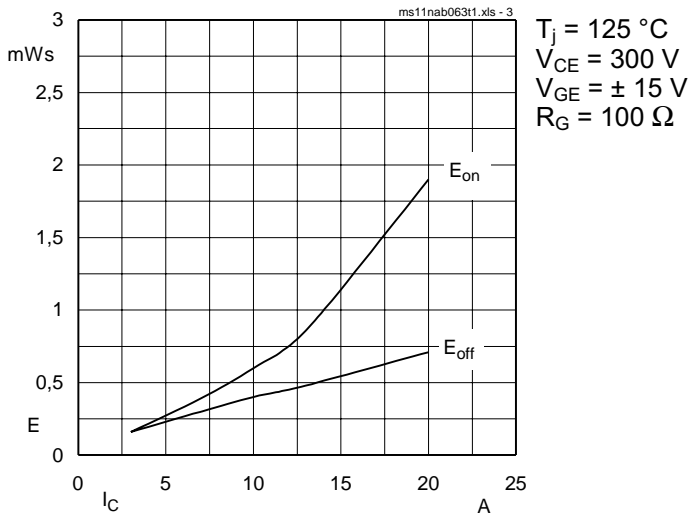

Fig. 3 Turn-on /-off energy =  $f(I_C)$

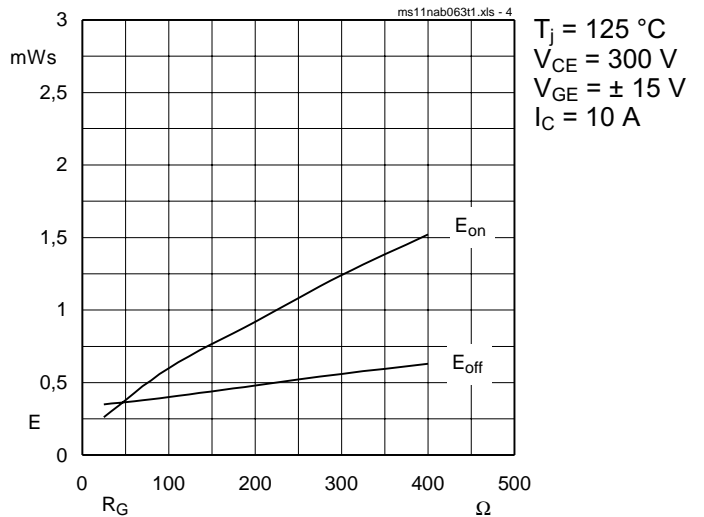

Fig. 4 Turn-on /-off energy =  $f(R_G)$

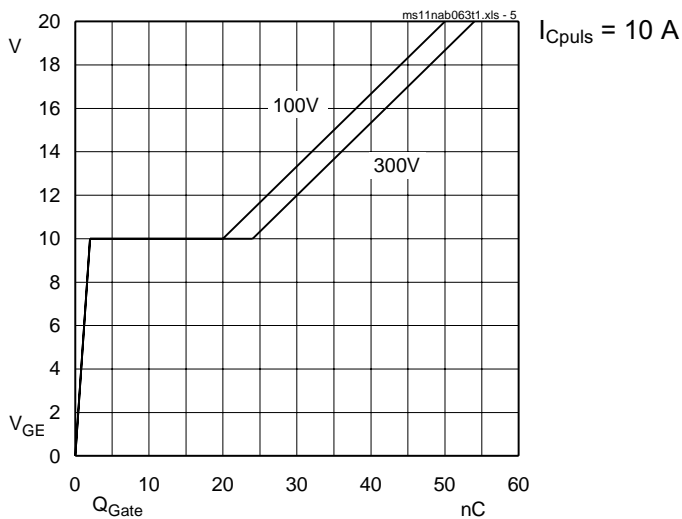

Fig. 5 Typ. gate charge characteristic

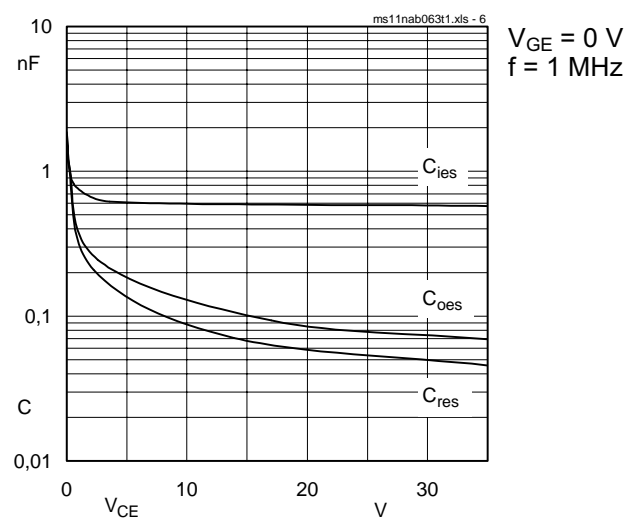

Fig. 6 Typ. capacitances vs.  $V_{CE}$

## 2. Common characteristics of MiniSKiiP

### MiniSKiiP 600 V

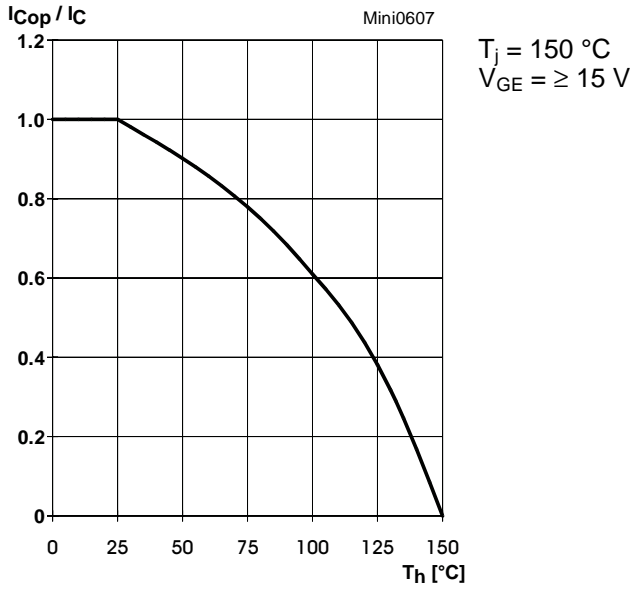

Fig. 7 Rated current of the IGBT  $I_{COP} / I_C = f(T_h)$

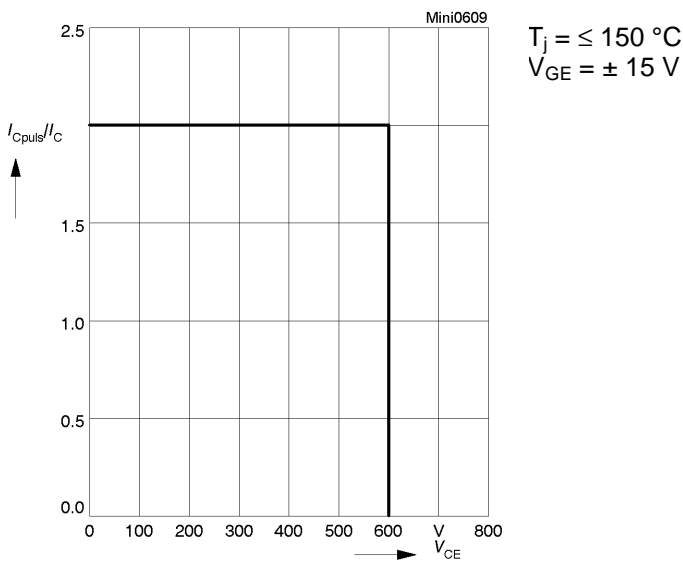

Fig. 9 Turn-off safe operating area (RBSOA) of the IGBT

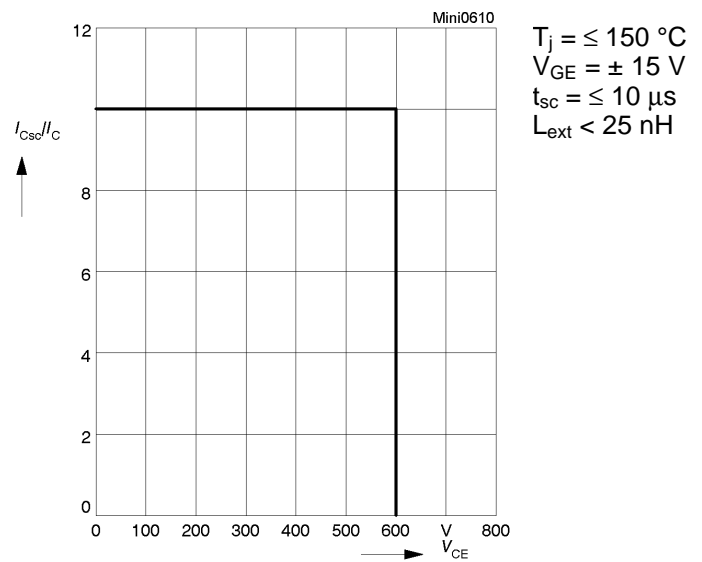

Fig. 10 Safe operating area at short circuit of the IGBT

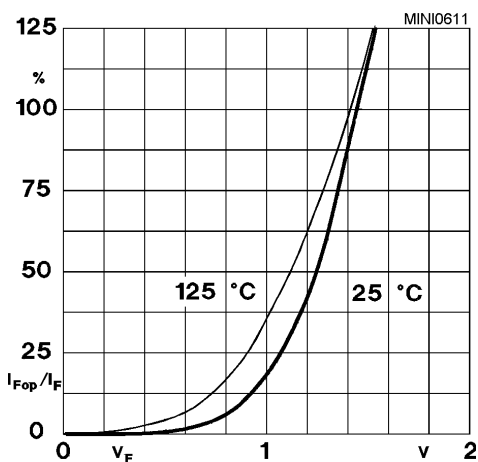

Fig. 11 Typ. freewheeling diode forward characteristic

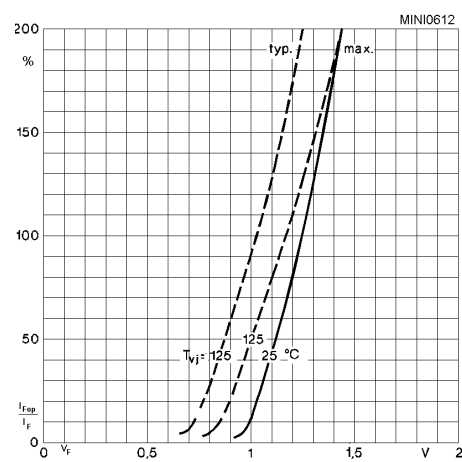
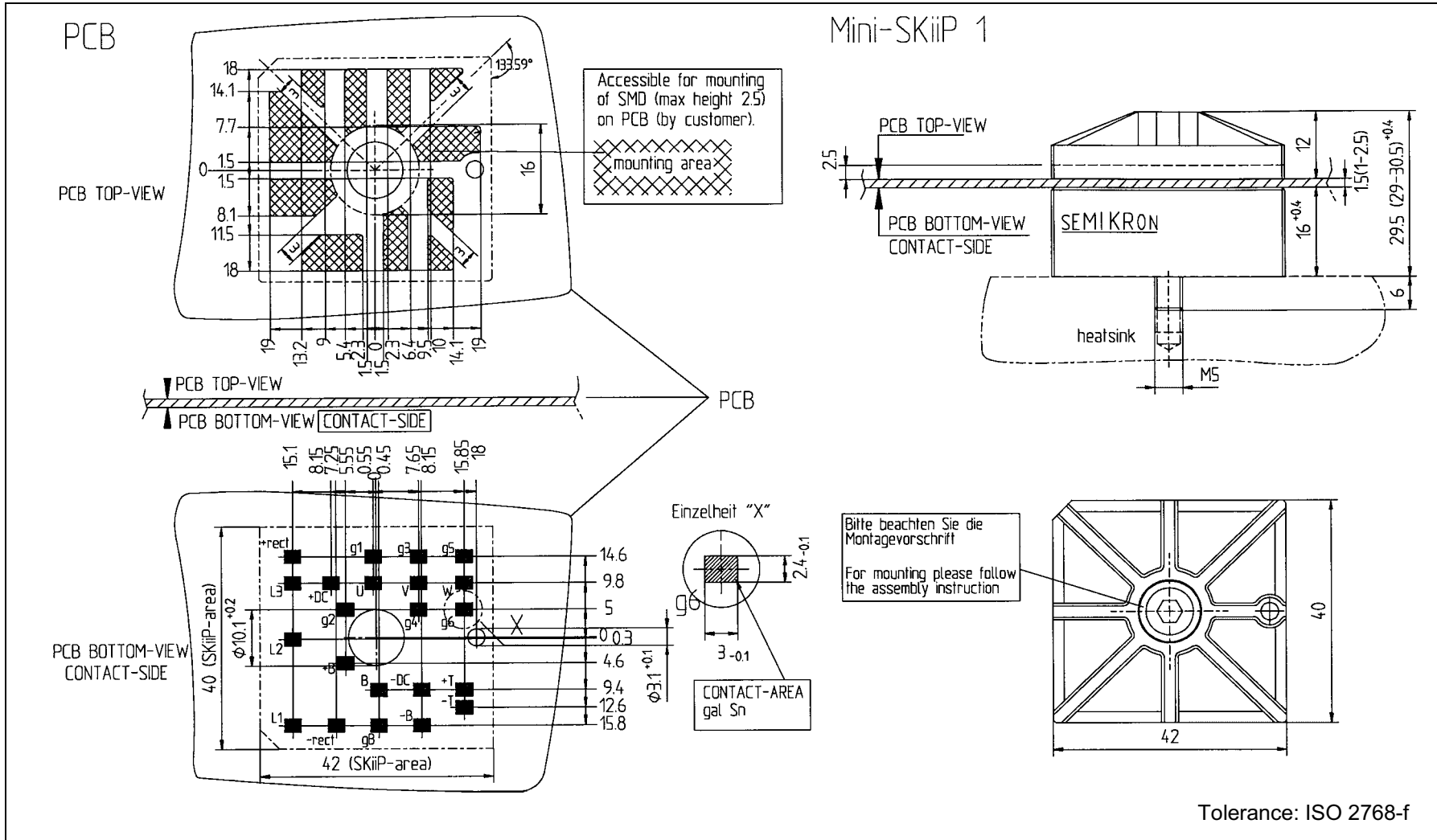
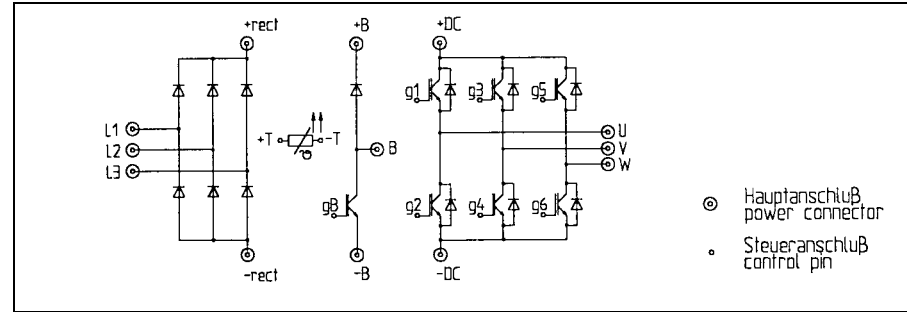

Fig. 12 Forward characteristic of the input bridge diode

### MiniSKiiP 1

SKiiP 10 NAB 063 T1  
SKiiP 11 NAB 063 T1



### 3. Circuits, Cases, Layout for the Printed Circuit Board