



STV9381

CLASS-D VERTICAL DEFLECTION AMPLIFIER FOR TV AND MONITOR APPLICATION

FEATURES

- HIGH EFFICIENCY POWER AMPLIFIER
- NO HEATSINK
- SPLIT SUPPLY
- INTERNAL FLYBACK GENERATOR
- OUTPUT CURRENT UP TO 3 APP
- SUITABLE FOR DC COUPLING APPLICATION
- FEW EXTERNAL COMPONENTS
- PROTECTION AGAINST LOW V_{CC}

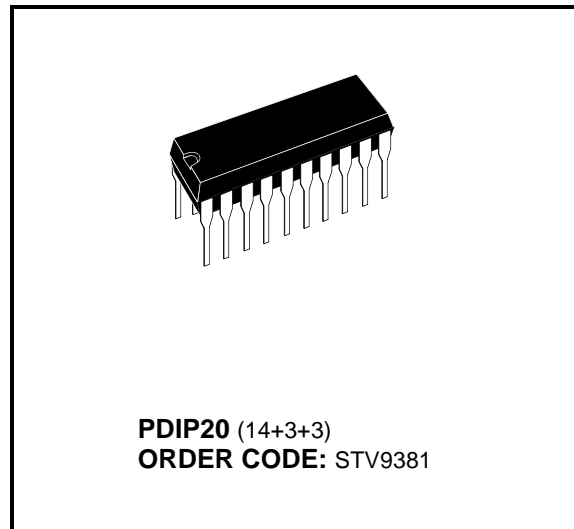

DESCRIPTION

Designed for monitors and TVs, the STV9381 is a class-D vertical deflection booster assembled in PDIP20 Package.

It operates with supplies up to +/- 18V, provides up to 3 App output current to drive the yoke. The internal flyback generator avoids the need for an extra power supply.

PIN CONNECTION

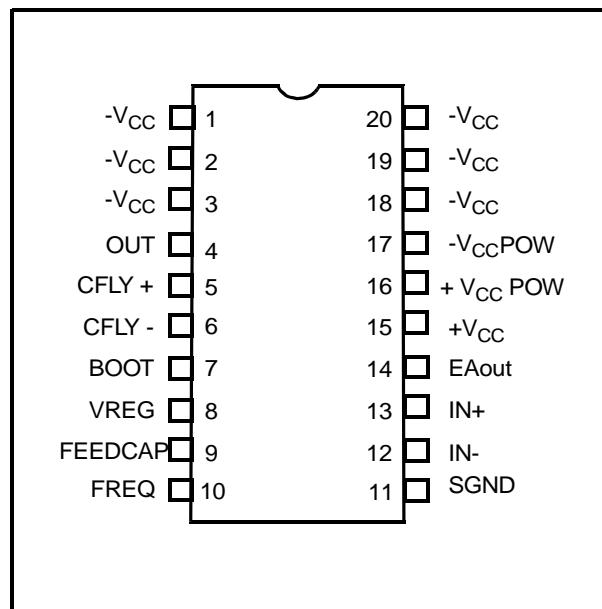

1 PIN FUNCTIONS

Pin Number	Name	Function
1	$-V_{CC}$	Negative supply
2	$-V_{CC}$	Negative supply
3	$-V_{CC}$	Negative supply
4	OUT	PWM Output
5	CFLY+	Flyback capacitor
6	CFLY-	Flyback capacitor
7	BOOT	Bootstrap capacitor
8	VREG	Internal voltage regulator
9	FEEDCAP	Feed-back integrating capacitor
10	FREQ	Frequency setting resistor
11	SGND	Signal Ground
12	IN-	Error amplifier inverting input
13	IN+	Error amplifier non-inverting input
14	EA out	Error amplifier output
15	$+V_{CC}$	Positive supply
16	$+V_{CC}POW$	Positive Power supply
17	$-V_{CC}POW$	Negative Power supply
18	$-V_{CC}$	Negative supply
19	$-V_{CC}$	Negative supply
20	$-V_{CC}$	Negative supply

2 FUNCTIONAL DESCRIPTION

The STV9381 is a vertical deflection circuit operating in class D. The class D is a modulation method where the output transistors work in switching mode at high frequency. The output signal is restored by filtering the output square wave with an external LC filter. The major interest of this IC is the low power dissipation comparatively to traditional amplifiers operating in class AB, eliminating the need of a heatsink.

Except for the output stage which uses the class D modulation, the circuit operation is similar to the one of a traditional linear vertical amplifier.

A reference signal (sawtooth) has to be applied to the circuit which can accept a differential or single ended signal. This sawtooth is amplified and applied as a current to the deflection yoke. This current is measured by means of a low value resistor. The resulting voltage is used as a feed-back signal to guarantee the conformity of the yoke current with the reference input signal.

The overvoltage necessary for a fast retrace is obtained with a chemical capacitor charged at the power supply voltage of the circuit. At the flyback moment this capacitor is connected in series with the output stage power supply. This method, used for several years with the linear vertical boosters and called "internal flyback" or "flyback generator", avoids the need of an additional power supply, while reducing the flyback duration.

The circuit uses a BCD process that combines Bipolar, CMOS and DMOS devices. DMOS transistors are used in the output stage due to the absence of second breakdown.

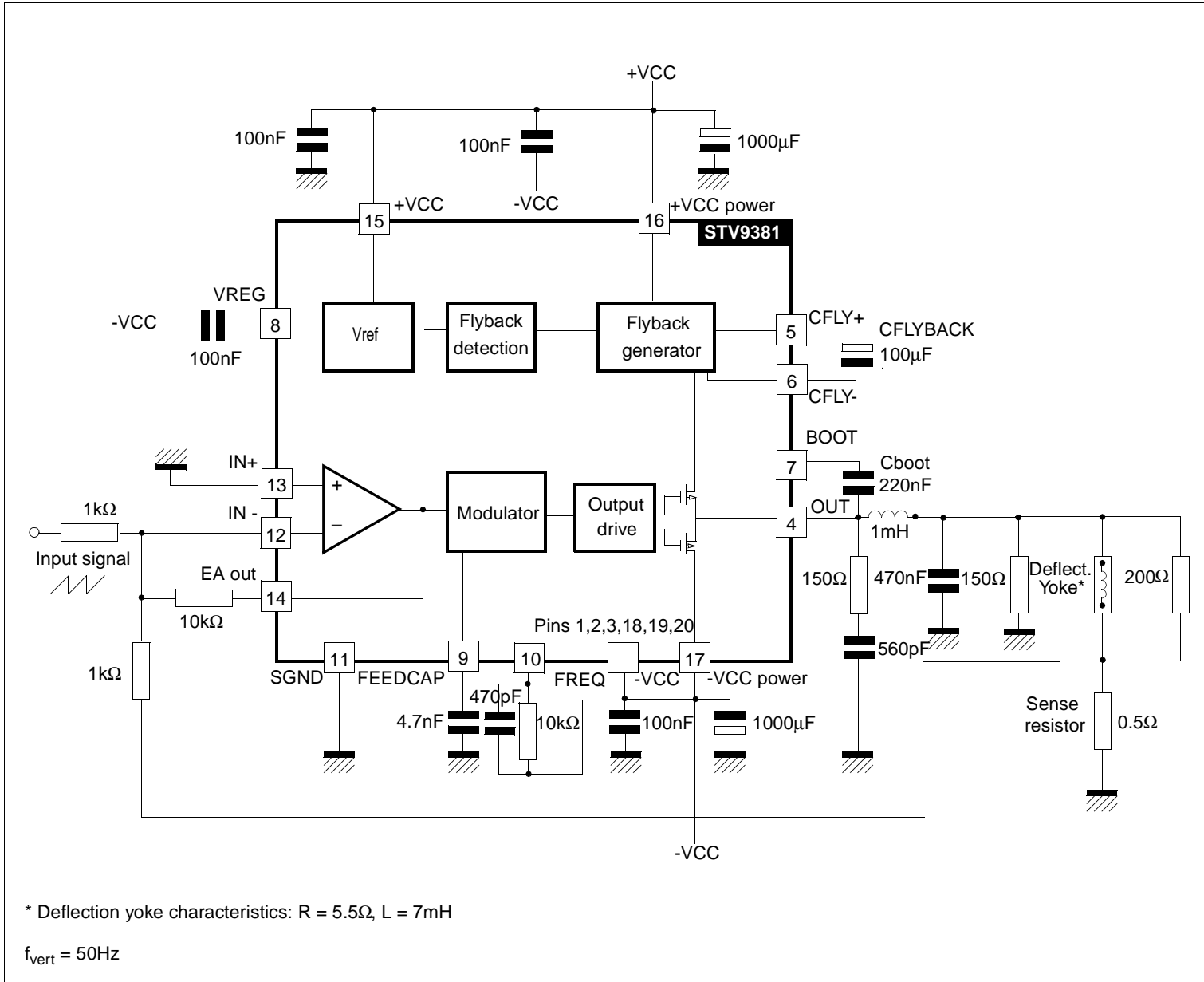
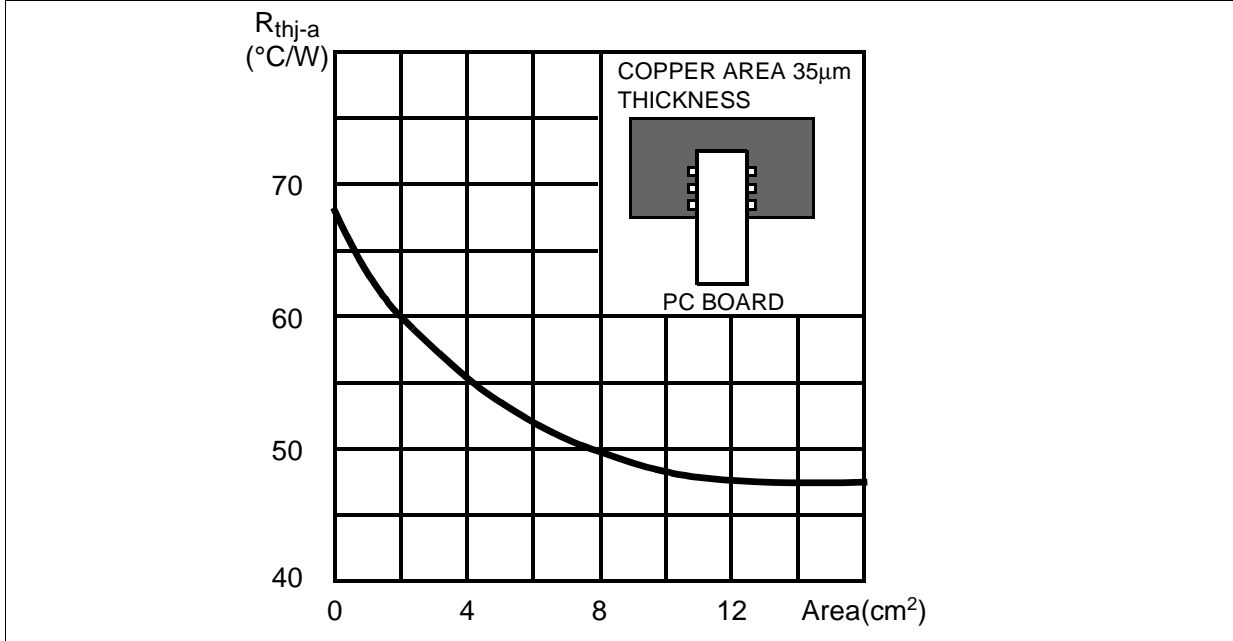

Figure 1. Test and application circuit

Figure 2. Rth with “on board” Square Heatsink vs. copper area



3 ABSOLUTE MAXIMUM RATINGS

Symbol	Parameter	Value	Unit
VCC	DC Supply Voltage	±20	V
T _{stg} , T _j	Storage and Junction Temperature	-40 to +150	°C
T _{op}	Operating Temperature Range	0 to +70	°C
VESD	ESD Susceptibility - Human Body Model (100 pF discharge through 1.5 kΩ)	±2	kV
I _{out}	Output current	±2	A
V _{out}	Maximum output voltage (pin 4) with respect to -Vcc (pins 1, 2, 3, 18, 19, 20) and during flyback (see Note 1)	80	V

Note: 1 During the flyback with Vcc=±18V, the maximum output voltage (pin 4) is close to 72V, with respect to -Vcc (pins 1, 2, 3, 18, 19, 20).

4 THERMAL DATA

Symbol	Parameter	Value	Unit
R _{th j-amb}	Thermal resistance Junction to ambient	70	°C/W

Pins 1, 2, 3, 18, 19, 20 are internally connected together and participate to heat evacuation.

5 ELECTRICAL CHARACTERISTICS (refer to Figure 1 on page 3)

T_{amb} = 25°C unless otherwise specified, V_{cc} = ±12V, f_{vert}=50Hz

Symbol	Parameter	Test Conditions	Min.	Typ.	Max.	Units
+V _{cc}	Positive supply range		+10		+18	V
-V _{cc}	Negative supply range		-18		-10	V
ΔV _{cc}	Maximum recommended difference between +V _{cc} and -V _{cc}				±4	V
V _{cc_start}	Low V _{cc} detection			±6.5		V
I _q	Quiescent supply current	Input voltage = 0		14		mA
I _y	Maximum vertical yoke current				±1.5	A
I ₁₃ , I ₁₂	Amplifier Input bias current			-0.1		μA
V _{OS}	Output Offset voltage	Note 2	-50		+50	mV
SVR	Supply voltage rejection	Note 3		82		dB
Fly _{thr}	Flyback detection threshold (positive slope)	V(14)		1.5		V
Fly _{thf}	Flyback detection threshold (negative slope)	V(14)		0.5		V
F _{sw}	Switching frequency	R _{freq} = 10kΩ	120	140	160	kHz
F _{sw - op}	Switching frequency operative range		100		200	kHz
R _{freq}	Frequency controller resistor range	Pin 10	7	10	14	kΩ

Note: 2 Input voltage = 0, measured after the filter (e.g. across the 470 nF filter capacitor)

Note: 3 Supply rejection of the positive or negative power supply. V_{cc} ripple = 1V_{pp}, f = 100Hz, measured on the sense resistor.

6 PACKAGE MECHANICAL DATA

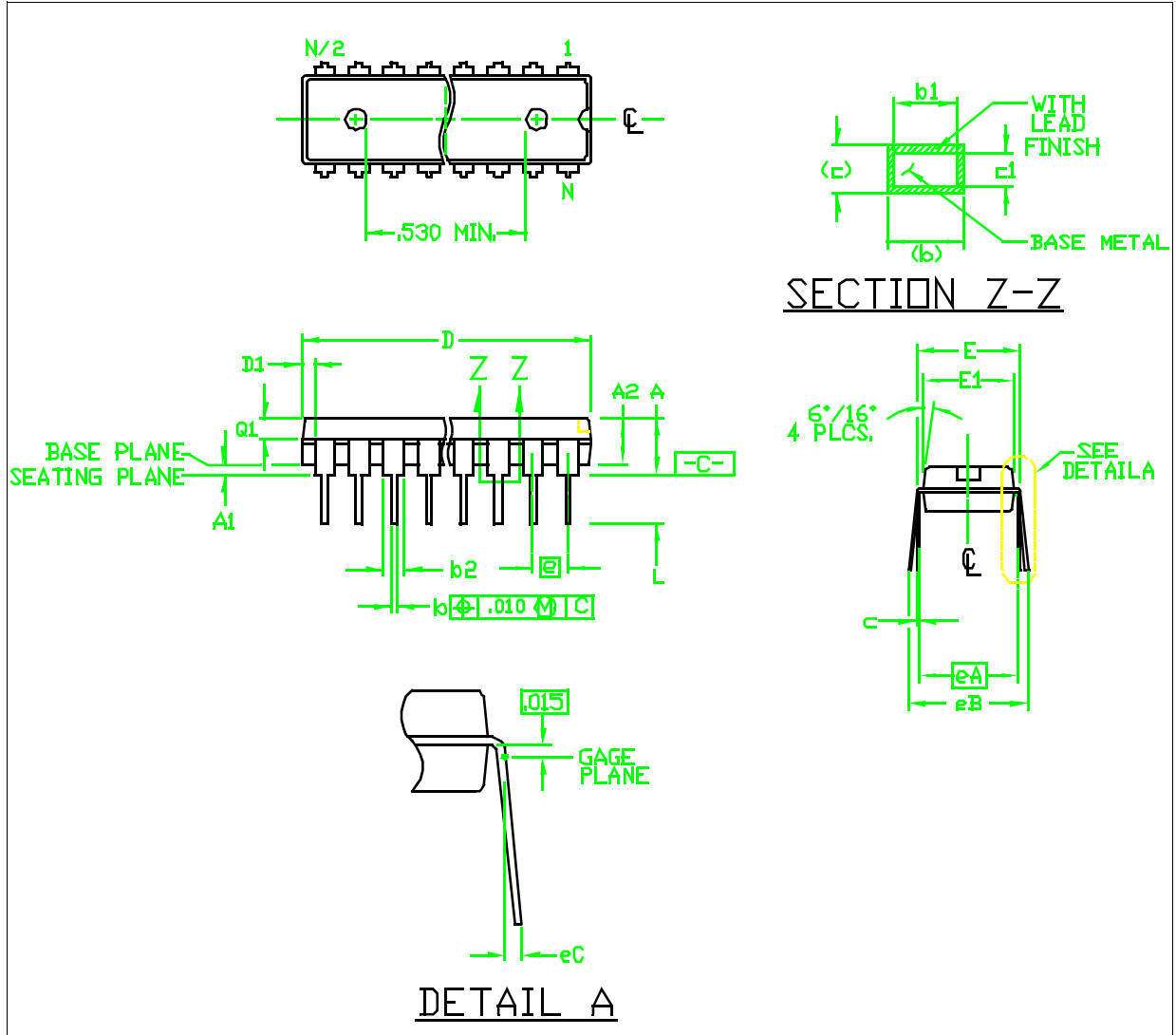

Dimensions	Millimeters			Inches			Notes
	Min.	Typ.	Max.	Min.	Typ.	Max.	
A			5.334			0.210	3
A1	0.381			0.015			3
A2	2.921	3.302	4.953	0.115	0.130	0.195	
b	0.381	0.457	0.559	0.015	0.018	0.022	
b1	0.356	0.457	0.508	0.014	0.018	0.020	
b2	1.397	1.524	1.651	0.055	0.060	0.065	8
c	0.203	0.254	0.305	0.008	0.010	0.012	
c1	0.203	0.254	0.279	0.008	0.010	0.011	
D	26.035	26.162	26.289	1.025	1.030	1.035	4

Dimensions	Millimeters			Inches			Notes
	Min.	Typ.	Max.	Min.	Typ.	Max.	
D1	0.762	0.889	1.016	0.030	0.035	0.040	4
E	7.62		8.255	0.300		0.325	5
E1	6.096	6.401	6.604	0.240	0.252	0.260	4
e		2.54			0.100		
eA		7.62			0.300		5
eB			10.922			0.430	6
eC	0.000		1.524	0.000		0.060	6
L	3.175		3.429	0.125		0.135	3
N	20			20			7
Q1	1.397	1.524	1.651	0.055	0.060	0.065	

Note: 3 Dimensions A, A1 & L are measured with the package seated in JEDEC seating plane gauge GS-3

Note: 4 Dimensions D, D1 and E1 are to be measured at maximum material condition but do not include mold flash or protrusions. Mold flash or protrusions shall not exceed 0.010 inch /0.254 mm

Note: 5 E and eA measured with the leads constrained to be perpendicular to datum -c-

Note: 6 eB and eC are measured at the lead tips with the leads unconstrained

Note: 7 N is the maximum of number of lead positions

Note: 8 b2 maximum dimension does not include DAMBAR protrusions. DAMBAR protrusions shall not exceed 0.010inch / 0.25mm

Information furnished is believed to be accurate and reliable. However, STMicroelectronics assumes no responsibility for the consequences of use of such information nor for any infringement of patents or other rights of third parties which may result from its use. No license is granted by implication or otherwise under any patent or patent rights of STMicroelectronics. Specifications mentioned in this publication are subject to change without notice. This publication supersedes and replaces all information previously supplied. STMicroelectronics products are not authorized for use as critical components in life support devices or systems without the express written approval of STMicroelectronics.

The ST logo is a registered trademark of STMicroelectronics

©2003 STMicroelectronics - All Rights Reserved.

Purchase of I²C Components by STMicroelectronics conveys a license under the Philips I²C Patent. Rights to use these components in an I²C system is granted provided that the system conforms to the I²C Standard Specification as defined by Philips.

STMicroelectronics Group of Companies

Australia - Brazil - Canada - China - Finland - France - Germany - Hong Kong - India - Israel - Italy - Japan - Malaysia - Malta - Morocco - Singapore - Spain Sweden - Switzerland - United Kingdom - United States.

<http://www.st.com>