

## 1N4933 THRU 1N4937

CURRENT 1.0 Ampere  
VOLTAGE 50 to 600 Volts

### Features

- Plastic package has Underwrites Laboratory Flammability Classification 94V-0
- Fast switching speed
- Construction utilizes void-free molded plastic technique
- 1.0A operation at  $T_A=75^\circ\text{C}$  with to terminal runaway
- High temperature soldering guaranteed :  $250^\circ\text{C}/10$  seconds, 0.375"(9.5mm) lead length, 5 lbs.(2.3kg) tension.

### Mechanical Data

- Case : JEDEC DO-41 molded plastic body
- Terminals : Plated axial lead solderable per MIL-STD-750, method 2026
- Polarity : Color band denotes cathode end
- Mounting Position : Any
- Weight : 0.012 ounce, 0.34 gram

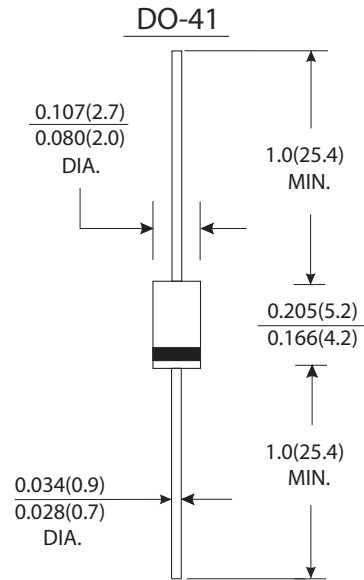

Dimensions in inches and (millimeters)

### Maximum Ratings And Electrical Characteristics

(Ratings at  $25^\circ\text{C}$  ambient temperature unless otherwise specified, Single phase, half wave 60Hz, resistive or inductive load. For capacitive load, derate by 20%)

	Symbols	1N4933	1N4934	1N4935	1N4936	1N4937	Units
Maximum recurrent peak reverse voltage	$V_{RRM}$	50	100	200	400	600	Volts
Maximum RMS voltage	$V_{RMS}$	35	70	140	280	420	Volts
Maximum DC blocking voltage	$V_{DC}$	50	100	200	400	600	Volts
Maximum average forward rectified current 0.375"(9.5mm) lead length $T_A=75^\circ\text{C}$	$I_{(AV)}$	1.0					Amp
Peak forward surge current 8.3ms single half sine-wave superimposed on rated load (JEDEC method) at $T_A=75^\circ\text{C}$	$I_{FSM}$	30.0					Amps
Maximum instantaneous forward voltage at 1.0A	$V_F$	1.3					Volts
Maximum DC reverse current at rated DC blocking voltage	$I_R$	5.0					$\mu A$
Maximum full load reverse current full cycle average. 0.375"(9.5mm) lead length at $T_L=55^\circ\text{C}$		100					
Maximum reverse recovery time (Note 1)	$T_{rr}$	150					ns
Typical junction capacitance (Note 2)	$C_J$	15.0					pF
Operating junction and storage temperature range	$T_J$ $T_{STG}$	-65 to +150					$^\circ\text{C}$

#### Notes:

- (1) Test conditions:  $I_F=1.0A$ ,  $V_R=30V$ ,  $di/dt=50A/\mu S$ , and  $I_{rr}=10\%I_{RM}$ .
- (2) Measured at 1MHz and applied reverse voltage of 4.0 Volts.

## RATINGS AND CHARACTERISTIC CURVES 1N4933 THRU 1N4937

FIG.1-TYPICAL FORWARD CURRENT DERATING CURVE

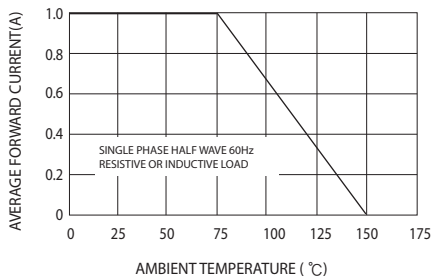

FIG.2-MAXIMUM NON-REPETITIVE FORWARD SURGE CURRENT

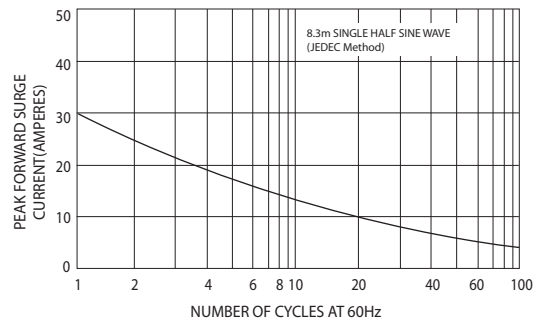

FIG.3-TYPICAL JUNCTION CAPACITANCE

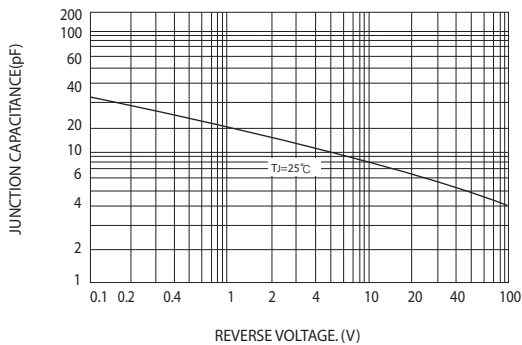

FIG.4-TYPICAL INSTANTANEOUS FORWARD CHARACTERISTICS

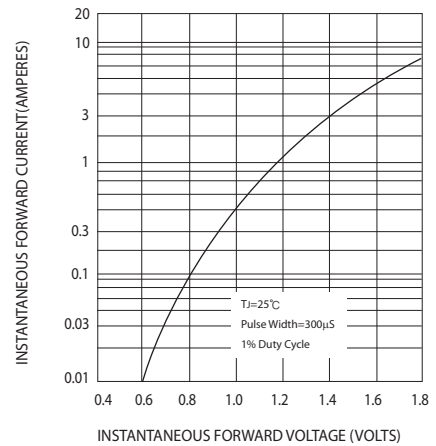
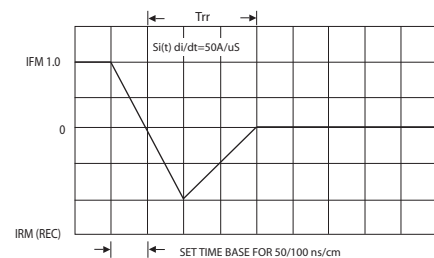
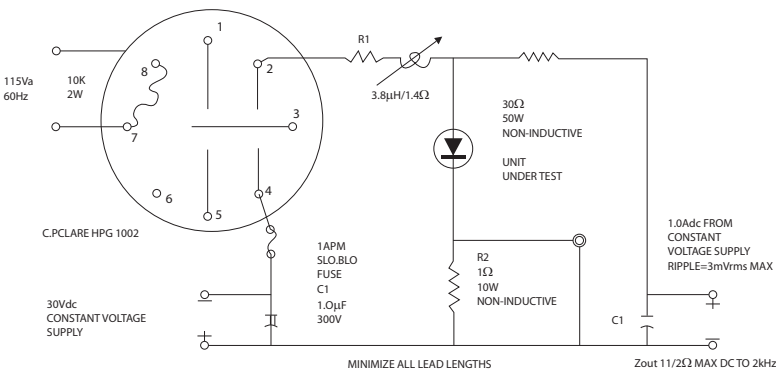

FIG.5-TEST CIRCUIT DIAGRAM AND REVERSE RECOVERY TIME CHARACTERISTIC



A. TEKTRONIX 545A, K PLUG IN PRE AMP P6000 PROBE OR EQUIVALENT R1-ADJUSTED FOR 1.4Ω BETWEEN POINT 2 OF RELAY AND RECTIFIER INDUCTIVE=3.8µH  
 R2-TEN-1W 10Ω% CARBON CORE IN PARALLEL TA=25 +10°C FOR RECTIFIER