

DATA SHEET

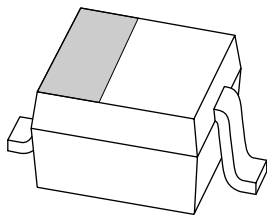

BAP63-03 Silicon PIN diode

Product specification
Supersedes data of 2001 May 18

2004 Feb 11

Silicon PIN diode

BAP63-03

FEATURES

- High speed switching for RF signals
- Low diode capacitance
- Low diode forward resistance
- Very low series inductance
- For applications up to 3 GHz.

APPLICATIONS

- RF attenuators and switches.

DESCRIPTION

Planar PIN diode in a SOD323 small SMD plastic package.

PINNING

PIN	DESCRIPTION
1	cathode
2	anode

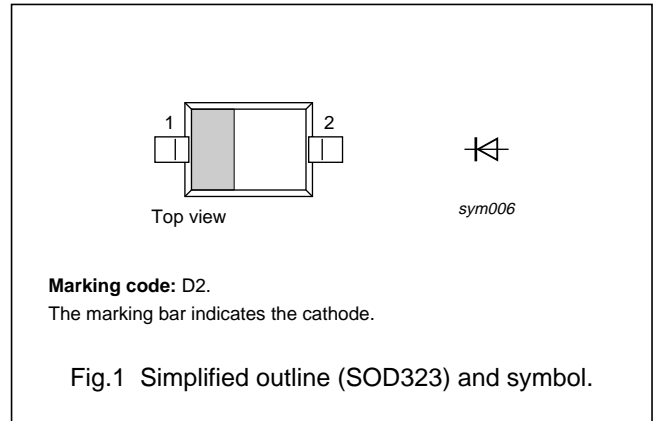

ORDERING INFORMATION

TYPE NUMBER	PACKAGE		
	NAME	DESCRIPTION	VERSION
BAP63-03	–	plastic surface mounted package; 2 leads	SOD323

LIMITING VALUES

In accordance with the Absolute Maximum Rating System (IEC 60134).

SYMBOL	PARAMETER	CONDITIONS	MIN.	MAX.	UNIT
V_R	continuous reverse voltage		–	50	V
I_F	continuous forward current		–	100	mA
P_{tot}	total power dissipation	$T_s \leq 90\text{ °C}$	–	500	mW
T_{stg}	storage temperature		–65	+150	°C
T_j	junction temperature		–65	+150	°C

Silicon PIN diode

BAP63-03

ELECTRICAL CHARACTERISTICST_j = 25 °C unless otherwise specified.

SYMBOL	PARAMETER	CONDITIONS	TYP.	MAX.	UNIT
V _F	forward voltage	I _F = 50 mA	0.95	1.1	V
I _R	reverse leakage current	V _R = 35 V	–	10	nA
C _d	diode capacitance	V _R = 0; f = 1 MHz	0.4	–	pF
		V _R = 1 V; f = 1 MHz	0.35	–	pF
		V _R = 20 V; f = 1 MHz	0.27	0.32	pF
r _D	diode forward resistance	I _F = 0.5 mA; f = 100 MHz; note 1	2.5	3.5	Ω
		I _F = 1 mA; f = 100 MHz; note 1	1.95	3	Ω
		I _F = 10 mA; f = 100 MHz; note 1	1.17	1.8	Ω
		I _F = 100 mA; f = 100 MHz; note 1	0.9	1.5	Ω
S ₂₁ ²	isolation	V _R = 0; f = 900 MHz	15.4	–	dB
		V _R = 0; f = 1800 MHz	10.1	–	dB
		V _R = 0; f = 2450 MHz	7.8	–	dB
S ₂₁ ²	insertion loss	I _F = 0.5 mA; f = 900 MHz	0.21	–	dB
		I _F = 0.5 mA; f = 1800 MHz	0.28	–	dB
		I _F = 0.5 mA; f = 2450 MHz	0.38	–	dB
S ₂₁ ²	insertion loss	I _F = 1 mA; f = 900 MHz	0.18	–	dB
		I _F = 1 mA; f = 1800 MHz	0.26	–	dB
		I _F = 1 mA; f = 2450 MHz	0.35	–	dB
S ₂₁ ²	insertion loss	I _F = 10 mA; f = 900 MHz	0.13	–	dB
		I _F = 10 mA; f = 1800 MHz	0.20	–	dB
		I _F = 10 mA; f = 2450 MHz	0.30	–	dB
S ₂₁ ²	insertion loss	I _F = 100 mA; f = 900 MHz	0.10	–	dB
		I _F = 100 mA; f = 1800 MHz	0.18	–	dB
		I _F = 100 mA; f = 2450 MHz	0.28	–	dB
τ _L	charge carrier life time	when switched from I _F = 10 mA to I _R = 6 mA; R _L = 100 Ω; measured at I _R = 3 mA	310	–	ns
L _S	series inductance		1.5	–	nH

Note

1. Guaranteed on AQL basis: inspection level S4, AQL 1.0.

THERMAL CHARACTERISTICS

SYMBOL	PARAMETER	VALUE	UNIT
R _{th(j-s)}	thermal resistance from junction to soldering point	120	K/W

Silicon PIN diode

BAP63-03

GRAPHICAL DATA

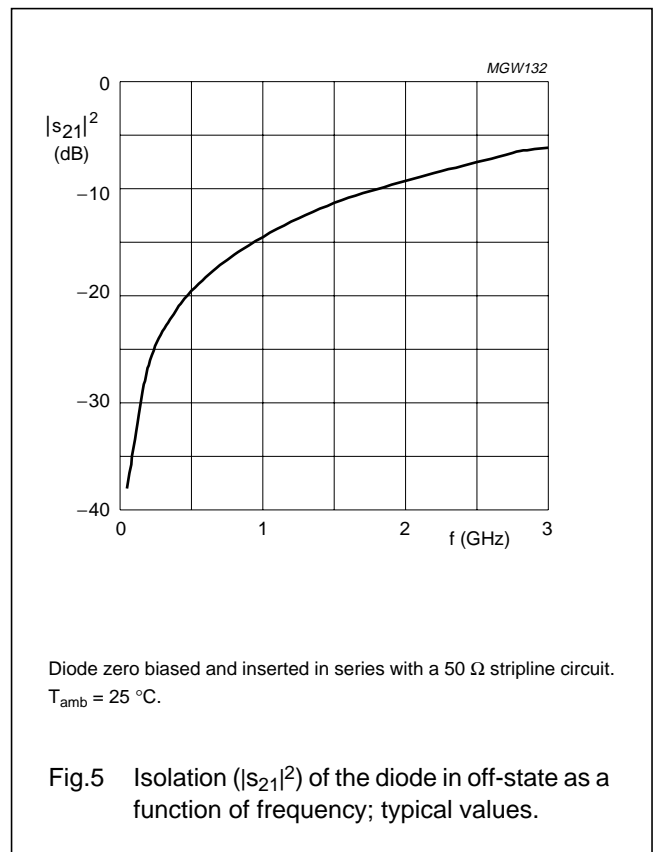
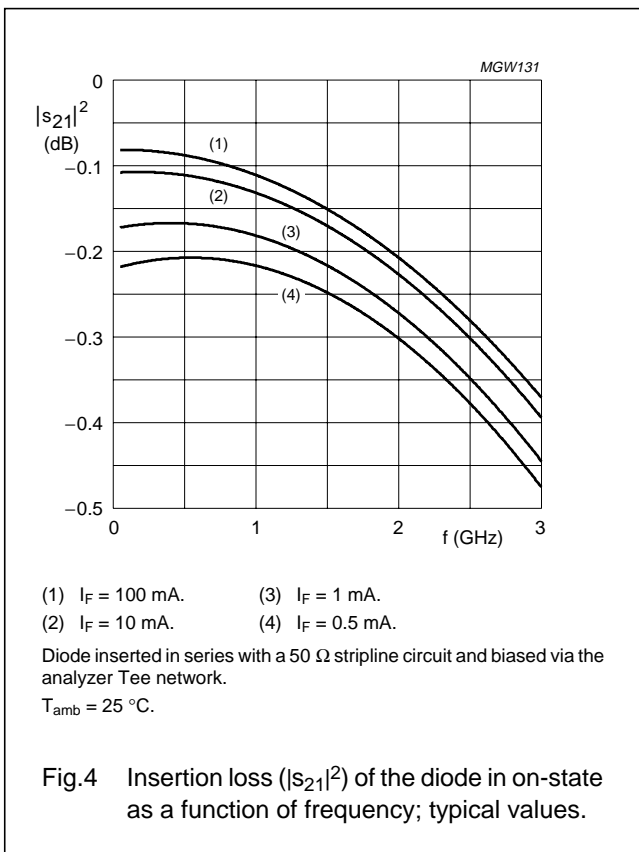
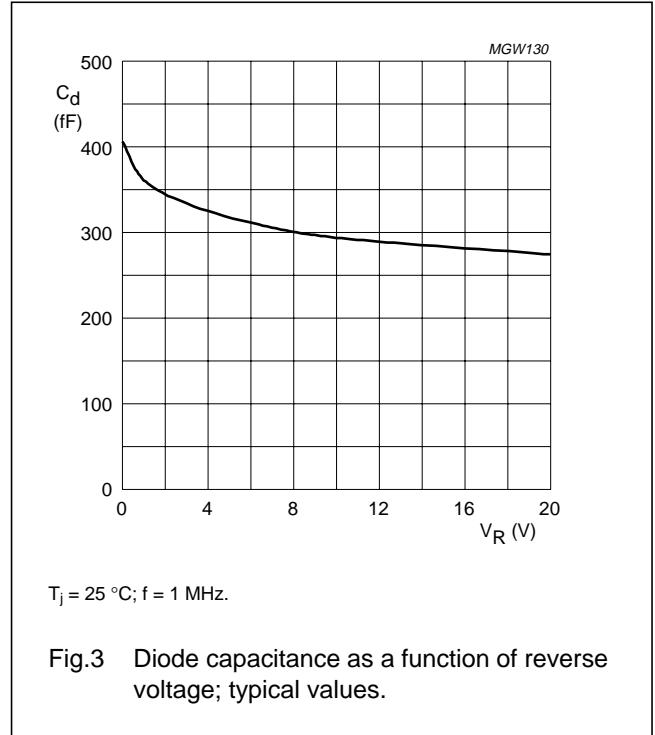
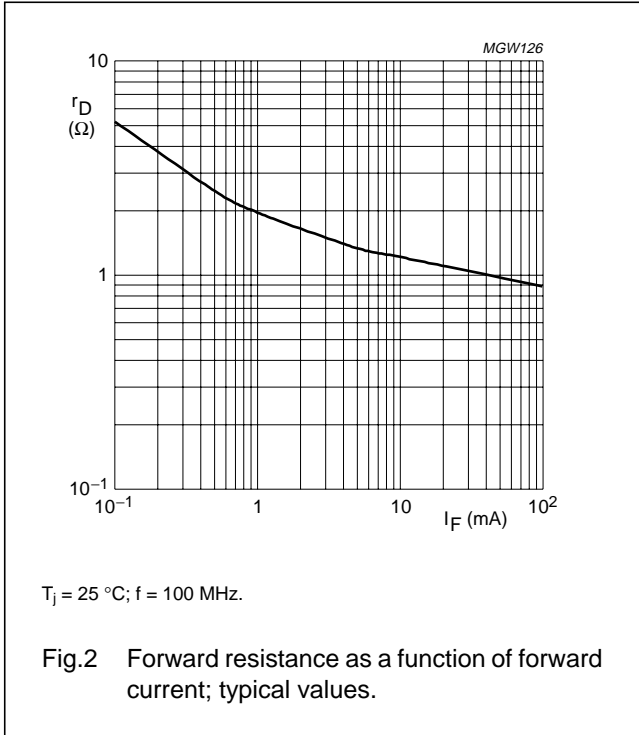

Silicon PIN diode

BAP63-03

PACKAGE OUTLINE

Plastic surface mounted package; 2 leads

SOD323

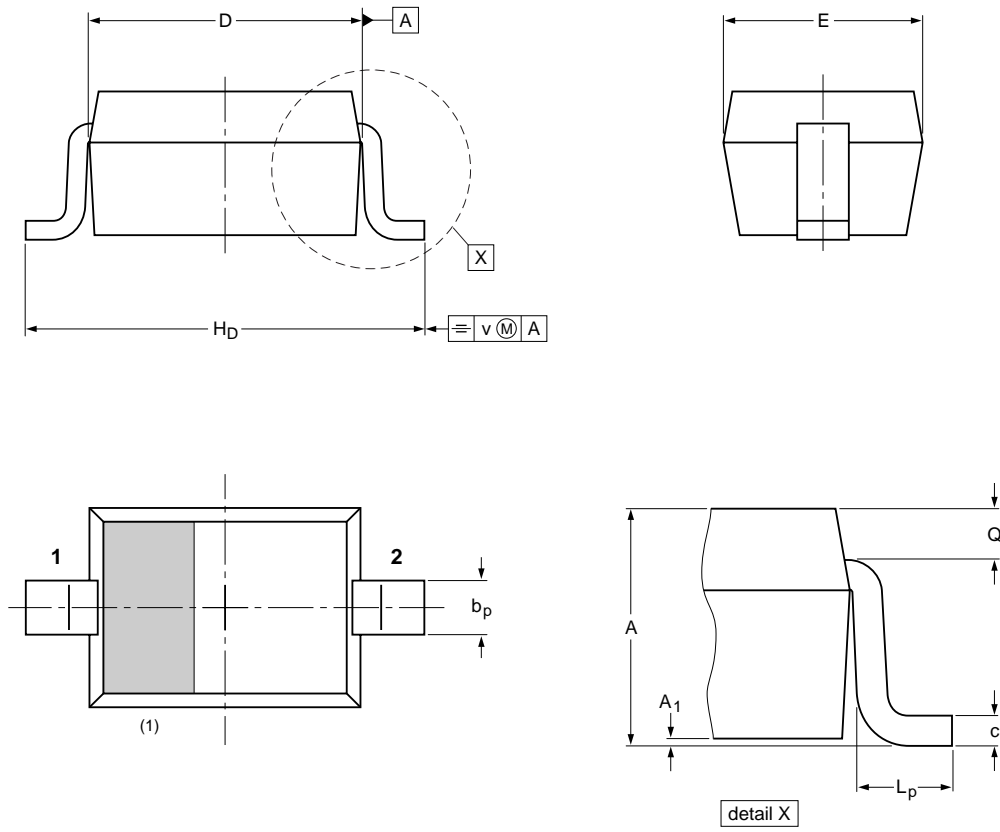

DIMENSIONS (mm are the original dimensions)

UNIT	A	A ₁ max	b _p	c	D	E	H _D	L _p	Q	v
mm	1.1 0.8	0.05	0.40 0.25	0.25 0.10	1.8 1.6	1.35 1.15	2.7 2.3	0.45 0.15	0.25 0.15	0.2

Note
1. The marking bar indicates the cathode

OUTLINE VERSION	REFERENCES				EUROPEAN PROJECTION	ISSUE DATE
	IEC	JEDEC	JEITA			
SOD323			SC-76			99-09-13 03-12-17

Silicon PIN diode

BAP63-03

DATA SHEET STATUS

LEVEL	DATA SHEET STATUS ⁽¹⁾	PRODUCT STATUS ⁽²⁾⁽³⁾	DEFINITION
I	Objective data	Development	This data sheet contains data from the objective specification for product development. Philips Semiconductors reserves the right to change the specification in any manner without notice.
II	Preliminary data	Qualification	This data sheet contains data from the preliminary specification. Supplementary data will be published at a later date. Philips Semiconductors reserves the right to change the specification without notice, in order to improve the design and supply the best possible product.
III	Product data	Production	This data sheet contains data from the product specification. Philips Semiconductors reserves the right to make changes at any time in order to improve the design, manufacturing and supply. Relevant changes will be communicated via a Customer Product/Process Change Notification (CPCN).

Notes

1. Please consult the most recently issued data sheet before initiating or completing a design.
2. The product status of the device(s) described in this data sheet may have changed since this data sheet was published. The latest information is available on the Internet at URL <http://www.semiconductors.philips.com>.
3. For data sheets describing multiple type numbers, the highest-level product status determines the data sheet status.

DEFINITIONS

Short-form specification — The data in a short-form specification is extracted from a full data sheet with the same type number and title. For detailed information see the relevant data sheet or data handbook.

Limiting values definition — Limiting values given are in accordance with the Absolute Maximum Rating System (IEC 60134). Stress above one or more of the limiting values may cause permanent damage to the device. These are stress ratings only and operation of the device at these or at any other conditions above those given in the Characteristics sections of the specification is not implied. Exposure to limiting values for extended periods may affect device reliability.

Application information — Applications that are described herein for any of these products are for illustrative purposes only. Philips Semiconductors make no representation or warranty that such applications will be suitable for the specified use without further testing or modification.

DISCLAIMERS

Life support applications — These products are not designed for use in life support appliances, devices, or systems where malfunction of these products can reasonably be expected to result in personal injury. Philips Semiconductors customers using or selling these products for use in such applications do so at their own risk and agree to fully indemnify Philips Semiconductors for any damages resulting from such application.

Right to make changes — Philips Semiconductors reserves the right to make changes in the products - including circuits, standard cells, and/or software - described or contained herein in order to improve design and/or performance. When the product is in full production (status 'Production'), relevant changes will be communicated via a Customer Product/Process Change Notification (CPCN). Philips Semiconductors assumes no responsibility or liability for the use of any of these products, conveys no licence or title under any patent, copyright, or mask work right to these products, and makes no representations or warranties that these products are free from patent, copyright, or mask work right infringement, unless otherwise specified.

Philips Semiconductors – a worldwide company

Contact information

For additional information please visit <http://www.semiconductors.philips.com>. Fax: +31 40 27 24825

For sales offices addresses send e-mail to: sales.addresses@www.semiconductors.philips.com.

© Koninklijke Philips Electronics N.V. 2004

SCA76

All rights are reserved. Reproduction in whole or in part is prohibited without the prior written consent of the copyright owner.

The information presented in this document does not form part of any quotation or contract, is believed to be accurate and reliable and may be changed without notice. No liability will be accepted by the publisher for any consequence of its use. Publication thereof does not convey nor imply any license under patent- or other industrial or intellectual property rights.

Printed in The Netherlands

R77/04/pp7

Date of release: 2004 Feb 11

Document order number: 9397 750 12634

Let's make things better.

**Philips
Semiconductors**



PHILIPS