

V_{RSM}	=	4000 V
$I_{F(AV)M}$	=	4140 A
$I_{F(RMS)}$	=	6500 A
I_{FSM}	=	46×10^3 A
V_{F0}	=	0.905 V
r_F	=	0.109 mW

Rectifier Diode

5SDD 40H4000

Doc. No. 5SYA1176-00 March 05

- Very low on-state losses
- Optimum power handling capability

Blocking

*Maximum rated values*¹⁾

Parameter	Symbol	Conditions	Value	Unit
Repetitive peak reverse voltage	V_{RRM}	$f = 50$ Hz, $t_p = 10$ ms, $T_j = -40 \dots 160^\circ\text{C}$	4000	V
Non - repetitive peak reverse voltage	V_{RSM}	$f = 5$ Hz, $t_p = 10$ ms, $T_j = -40 \dots 160^\circ\text{C}$	4000	V

Characteristic values

Parameter	Symbol	Conditions	min	typ	max	Unit
Max. (reverse) leakage current	I_{RRM}	V_{RRM} , $T_j = 160^\circ\text{C}$			100	mA

Mechanical data

*Maximum rated values*¹⁾

Parameter	Symbol	Conditions	min	typ	max	Unit
Mounting force	F_M		45	50	55	kN
Acceleration	a	Device unclamped			50	m/s^2
Acceleration	a	Device clamped			100	m/s^2

Characteristic values

Parameter	Symbol	Conditions	min	typ	max	Unit
Weight	m			0.9		kg
Housing thickness	H	$F_M = 50$ kN, $T_a = 25^\circ\text{C}$	25.5		26.5	mm
Surface creepage distance	D_S		40			mm
Air strike distance	D_a		20			mm

1) Maximum rated values indicate limits beyond which damage to the device may occur

ABB Switzerland Ltd, Semiconductors reserves the right to change specifications without notice.



On-state

Maximum rated values ¹⁾

Parameter	Symbol	Conditions	min	typ	max	Unit
Max. average on-state current	$I_{F(AV)M}$	50 Hz, Half sine wave, $T_C = 85^\circ\text{C}$			4140	A
Max. RMS on-state current	$I_{F(RMS)}$				6500	A
Max. peak non-repetitive surge current	I_{FSM}	$t_p = 10\text{ ms}$, $T_j = 160^\circ\text{C}$, $V_R = 0\text{ V}$			46×10^3	A
Limiting load integral	I^2t				10.58×10^6	A^2s
Max. peak non-repetitive surge current	I_{FSM}	$t_p = 8.3\text{ ms}$, $T_j = 160^\circ\text{C}$, $V_R = 0\text{ V}$			49×10^3	A
Limiting load integral	I^2t				10.02×10^6	A^2s

Characteristic values

Parameter	Symbol	Conditions	min	typ	max	Unit
On-state voltage	V_F	$I_F = 4000\text{ A}$, $T_j = 160^\circ\text{C}$			1.310	V
Threshold voltage	$V_{(T0)}$	$T_j = 160^\circ\text{C}$			0.905	V
Slope resistance	r_T	$I_T = 6000 \dots 19000\text{ A}$			0.109	$\text{m}\Omega$

Switching

Characteristic values

Parameter	Symbol	Conditions	min	typ	max	Unit
Recovery charge	Q_{rr}	$di_F/dt = -30\text{ A}/\mu\text{s}$, $V_R = 100\text{ V}$ $I_{FRM} = 2000\text{ A}$, $T_j = 160^\circ\text{C}$		4600		μAs

Thermal

Maximum rated values ¹⁾

Parameter	Symbol	Conditions	min	typ	max	Unit
Operating junction temperature range	T _{vj}		-40		160	°C
Storage temperature range	T _{stg}		-40		160	°C

Characteristic values

Parameter	Symbol	Conditions	min	typ	max	Unit
Thermal resistance junction to case	R _{th(j-c)}	Double-side cooled F _m = 45...55 kN			8	K/kW
	R _{th(j-c)A}	Anode-side cooled F _m = 45...55 kN			14.5	K/kW
	R _{th(j-c)C}	Cathode-side cooled F _m = 45...55 kN			18.0	K/kW
Thermal resistance case to heatsink	R _{th(c-h)}	Double-side cooled F _m = 45...55 kN			2.5	K/kW
	R _{th(c-h)}	Single-side cooled F _m = 45...55 kN			5.0	K/kW

Analytical function for transient thermal impedance:

$$Z_{th(j-c)}(t) = \sum_{i=1}^n R_{th i} (1 - e^{-t/\tau_i})$$

i	1	2	3	4
R _{th i} (K/kW)	4.533	2.255	0.868	0.345
τ _i (s)	0.4406	0.1045	0.0092	0.0022

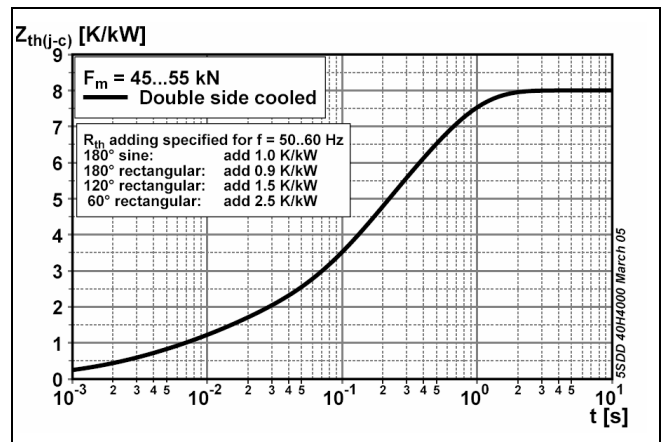

Fig. 1 Transient thermal impedance junction-to-case.

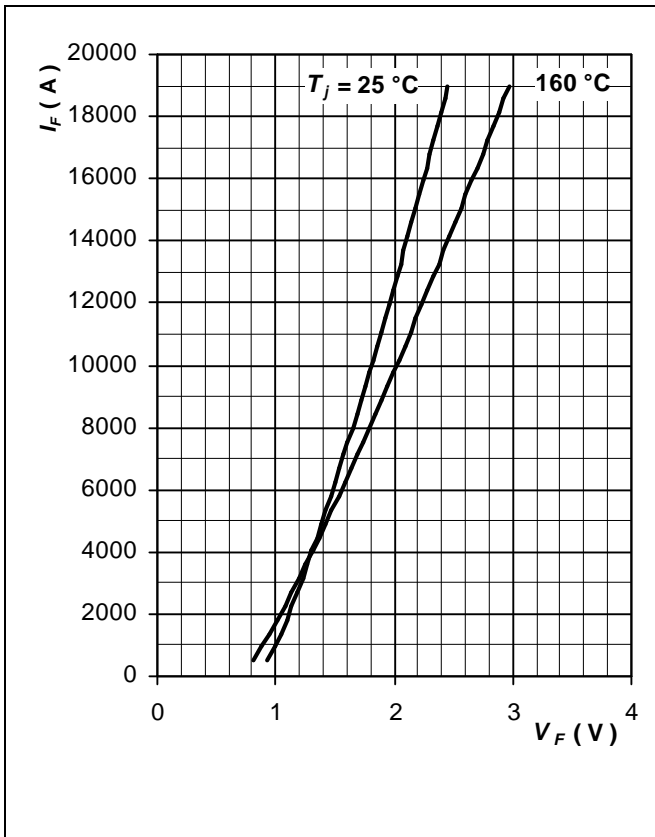

Fig. 2 Max. on-state characteristics.

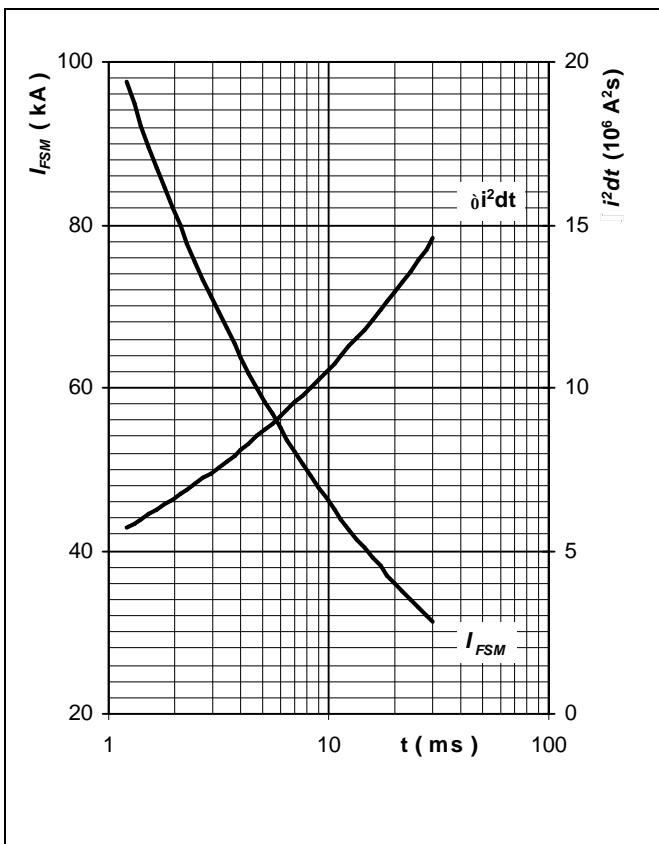

Fig. 3 Surge forward current vs. pulse length. Half sine wave, single pulse, $V_R = 0\text{ V}$

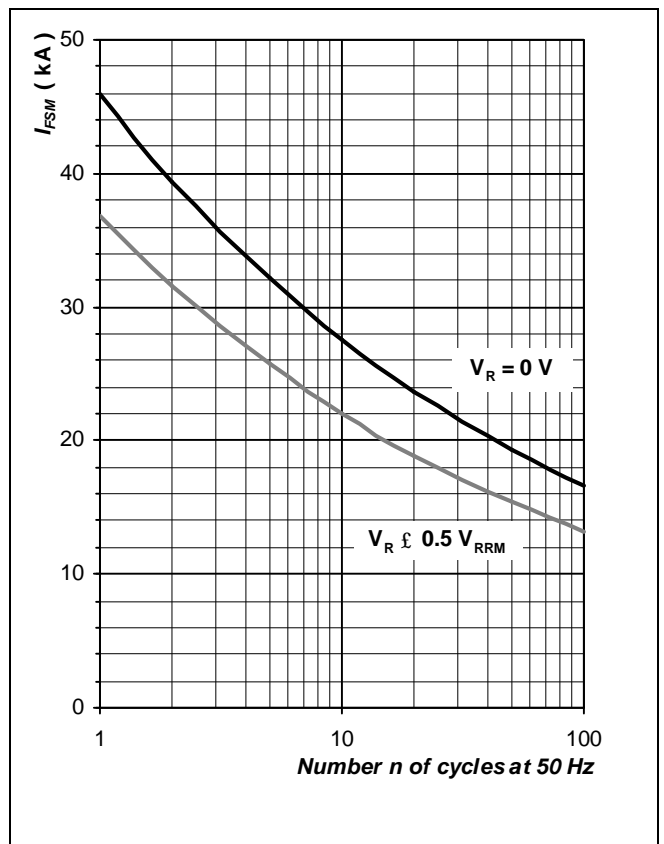

Fig. 4 Surge forward current vs. number of pulses. Half sine wave, $V_R = 0\text{ V}$

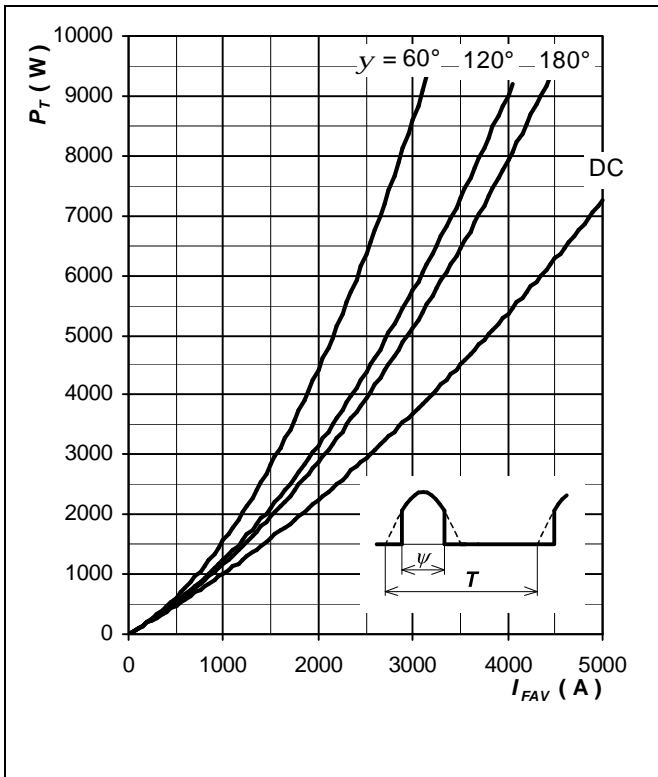

Fig. 5 Forward power loss vs. average forward current, sine waveform, $f = 50$ Hz

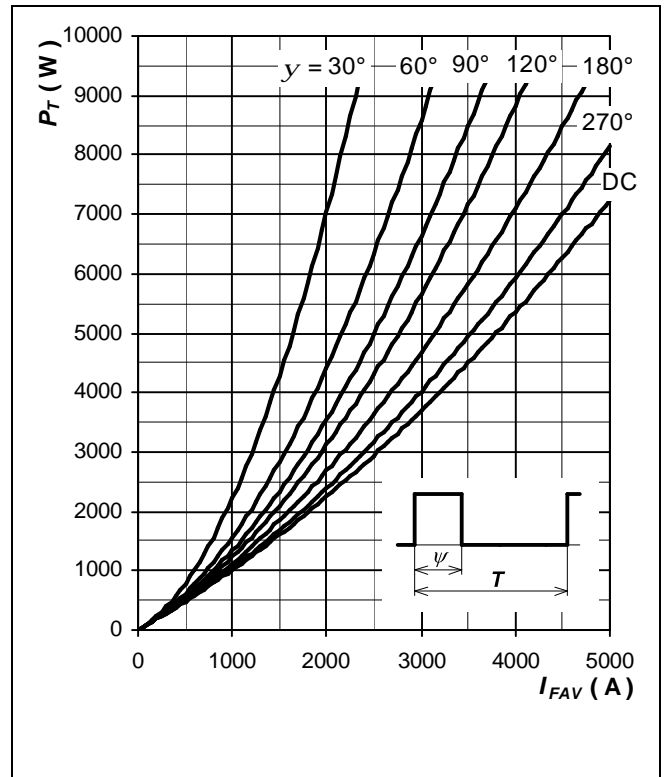

Fig. 6 Forward power loss vs. average forward current, square waveform, $f = 50$ Hz

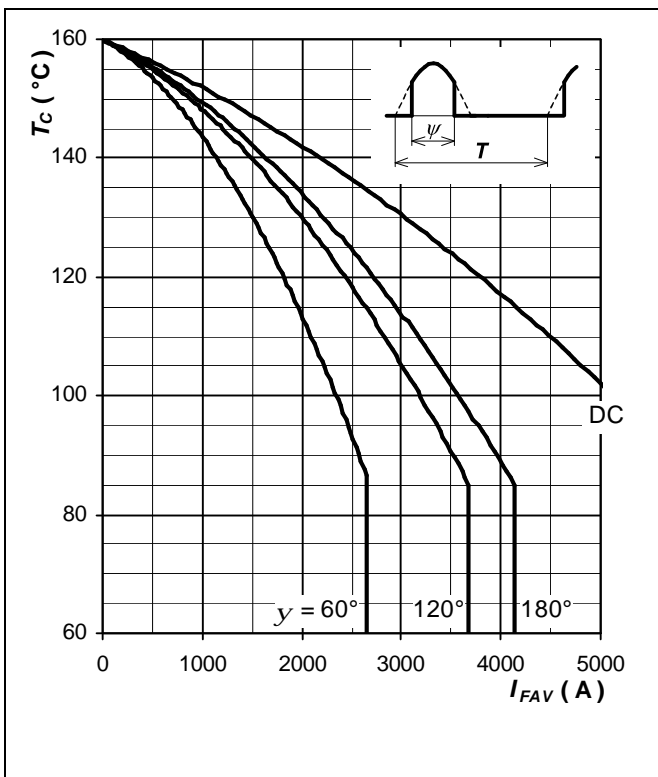

Fig. 7 Max. case temperature vs. aver. forward current, sine waveform, $f = 50$ Hz

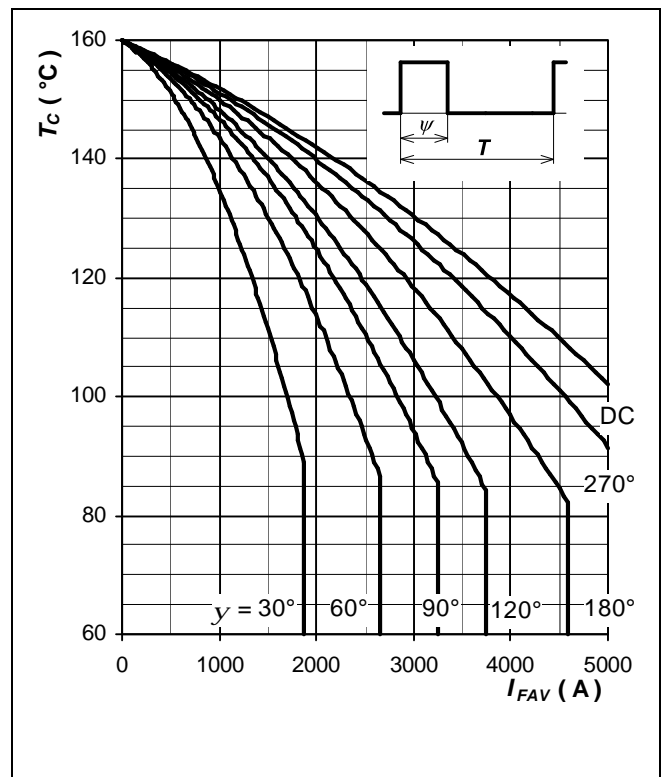

Fig. 8 Max. case temperature vs. aver. forward current, square waveform, $f = 50$ Hz

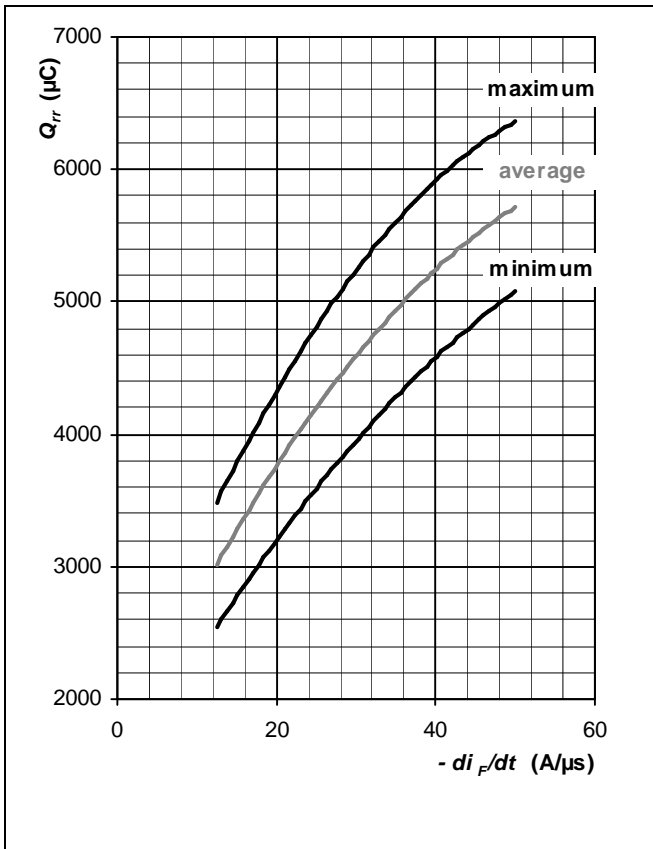

Fig. 9 Reverse recovery charge vs. di_F/dt ,
 $I_F = 2000 \text{ A}$, $V_R = 100 \text{ V}$, $T_j = T_{j\text{max}}$, limit values

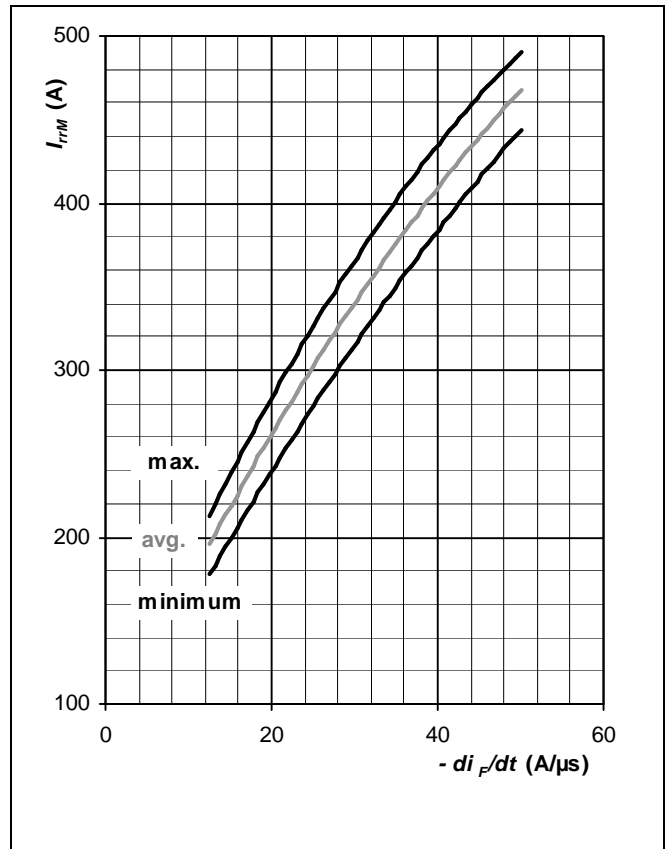

Fig. 10 Peak reverse recovery current vs. di_F/dt ,
 $I_F = 2000 \text{ A}$, $V_R = 100 \text{ V}$, $T_j = T_{j\text{max}}$, limit values

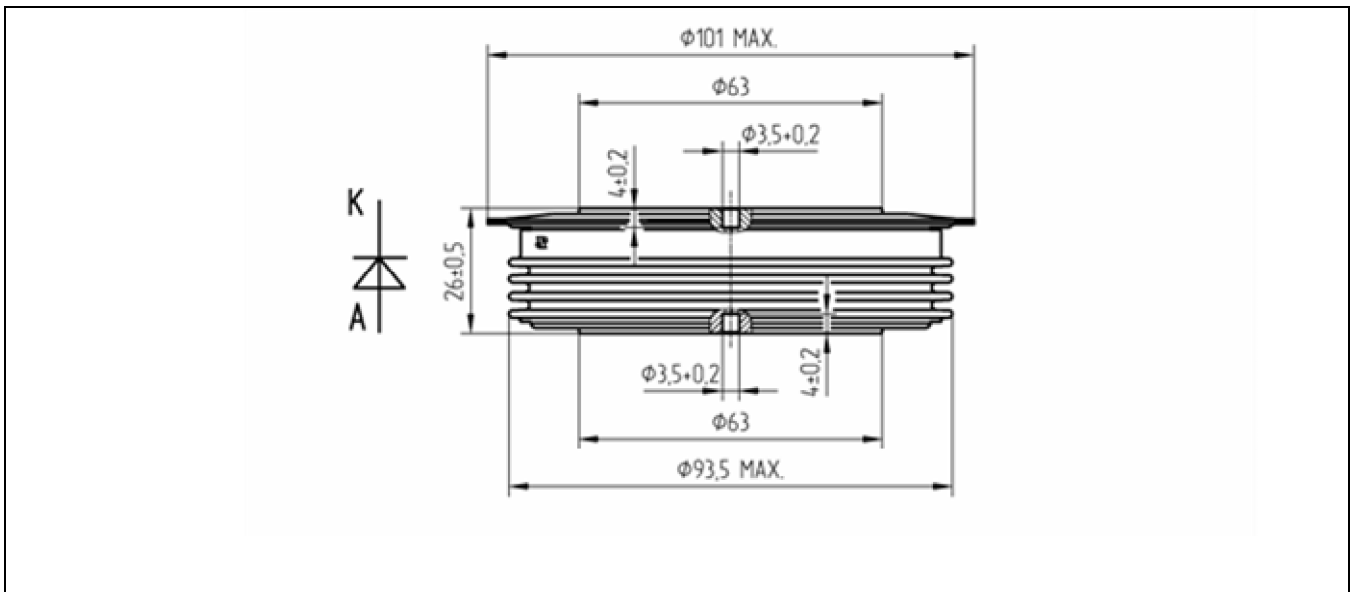

Fig. 11 Outline drawing. All dimensions are in millimeters and represent nominal values unless stated otherwise.

Related application notes:

Doc. Nr	Titel
5SYA 2020	Design of RC-Snubbers for Phase Control Applications
5SYA 2029	Designing Large Rectifiers with High Power Diodes
5SYA 2036	Recommendations regarding mechanical clamping of Press Pack High Power Semiconductors

Please refer to <http://www.abb.com/semiconductors> for actual versions.

ABB Switzerland Ltd, Semiconductors reserves the right to change specifications without notice.



ABB Switzerland Ltd
Semiconductors
 Fabrikstrasse 3
 CH-5600 Lenzburg, Switzerland

Doc. No. 5SYA1176-00 March 05

Telephone +41 (0)58 586 1419
 Fax +41 (0)58 586 1306
 Email abbsem@ch.abb.com
 Internet www.abb.com/semiconductors