



8ETL06SPbF
8ETL06-1PbF

Ultra-low V_F Hyperfast Rectifier for Discontinuous Mode PFC

Features

- Benchmark Ultra-low Forward Voltage Drop
- Hyperfast Recovery Time
- Low Leakage Current
- 175°C Operating Junction Temperature
- Lead-Free ("PbF" suffix)

$V_F = 0.96V$ typ.

$I_{F(AV)} = 8Amp$

$V_R = 600V$

Description

State of the art, ultra-low V_F , soft-switching Hyperfast Rectifiers optimized for Discontinuous (Critical) Mode (DCM) Power Factor Correction (PFC).

The minimised conduction loss, optimized stored charge and low recovery current minimize the switching losses and reduce over dissipation in the switching element and snubbers.

The device is also intended for use as a free wheeling diode in power supplies and other power switching applications.

Applications

AC-DC SMPS 70W-400W

e.g. Laptop & Printer AC Adaptors, Desktop PC, TV & Monitor, Games units and DVD AC-DC power supplies.

Absolute Maximum Ratings

Parameters	Max	Units
V_{RRM} Peak Repetitive Reverse Voltage	600	V
$I_{F(AV)}$ Average Rectified Forward Current @ $T_C = 160^\circ C$	8	A
I_{FSM} Non Repetitive Peak Surge Current @ $T_J = 25^\circ C$	175	
I_{FM} Peak Repetitive Forward Current	16	
T_J, T_{STG} Operating Junction and Storage Temperatures	- 65 to 175	$^\circ C$

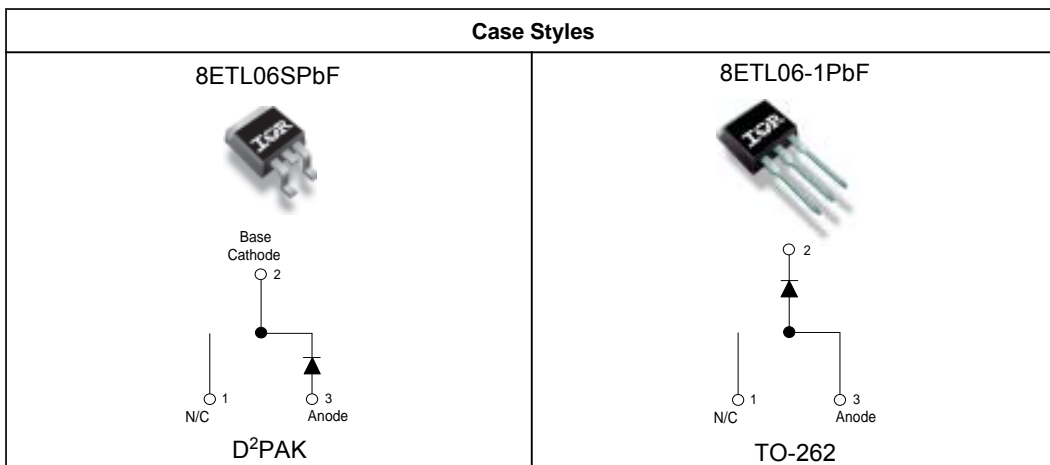

Electrical Characteristics @ $T_J = 25^\circ\text{C}$ (unless otherwise specified)

Parameters	Min	Typ	Max	Units	Test Conditions
V_{BR}, V_F Breakdown Voltage, Blocking Voltage	600	-	-	V	$I_R = 100\mu\text{A}$
V_F Forward Voltage	-	0.96	1.05	V	$I_F = 8\text{A}, T_J = 25^\circ\text{C}$
	-	0.81	0.86	V	$I_F = 8\text{A}, T_J = 150^\circ\text{C}$
I_R Reverse Leakage Current	-	0.05	5	μA	$V_R = V_R$ Rated
	-	20	100	μA	$T_J = 150^\circ\text{C}, V_R = V_R$ Rated
C_T Junction Capacitance	-	17	-	pF	$V_R = 600\text{V}$
L_S Series Inductance	-	8.0	-	nH	Measured lead to lead 5mm from package body

Dynamic Recovery Characteristics @ $T_C = 25^\circ\text{C}$ (unless otherwise specified)

Parameters	Min	Typ	Max	Units	Test Conditions
t_{rr} Reverse Recovery Time	-	60	100	ns	$I_F = 1\text{A}, di_F/dt = 100\text{A}/\mu\text{s}, V_R = 30\text{V}$
	-	150	250		$I_F = 8\text{A}, di_F/dt = 100\text{A}/\mu\text{s}, V_R = 30\text{V}$
	-	170	-		$T_J = 25^\circ\text{C}$
	-	250	-		$T_J = 125^\circ\text{C}$
I_{RRM} Peak Recovery Current	-	15	-	A	$T_J = 25^\circ\text{C}$
	-	20	-		$T_J = 125^\circ\text{C}$
Q_{rr} Reverse Recovery Charge	-	1.3	-	μC	$T_J = 25^\circ\text{C}$
	-	2.6	-		$T_J = 125^\circ\text{C}$

$I_F = 8\text{A}$
 $di_F/dt = 200\text{A}/\mu\text{s}$
 $V_R = 390\text{V}$

Thermal - Mechanical Characteristics

Parameters	Min	Typ	Max	Units
T_J Max. Junction Temperature Range	- 65	-	175	$^\circ\text{C}$
T_{Stg} Max. Storage Temperature Range	- 65	-	175	$^\circ\text{C}$
R_{thJC} Thermal Resistance, Junction to Case Per Leg	-	1.4	2	$^\circ\text{C}/\text{W}$
R_{thJA} ① Thermal Resistance, Junction to Ambient Per Leg	-	-	70	$^\circ\text{C}/\text{W}$
R_{thCS} ② Thermal Resistance, Case to Heatsink	-	0.5	-	$^\circ\text{C}/\text{W}$
Weight	-	2.0	-	g
	-	0.07	-	(oz)
Mounting Torque	6.0	-	12	Kg-cm
	5.0	-	10	lbf.in
Marking Device	8ETL06S		Case style D ² Pak	
	8ETL06-1		Case style TO-262	

① Typical Socket Mount

② Mounting Surface, Flat, Smooth and Greased

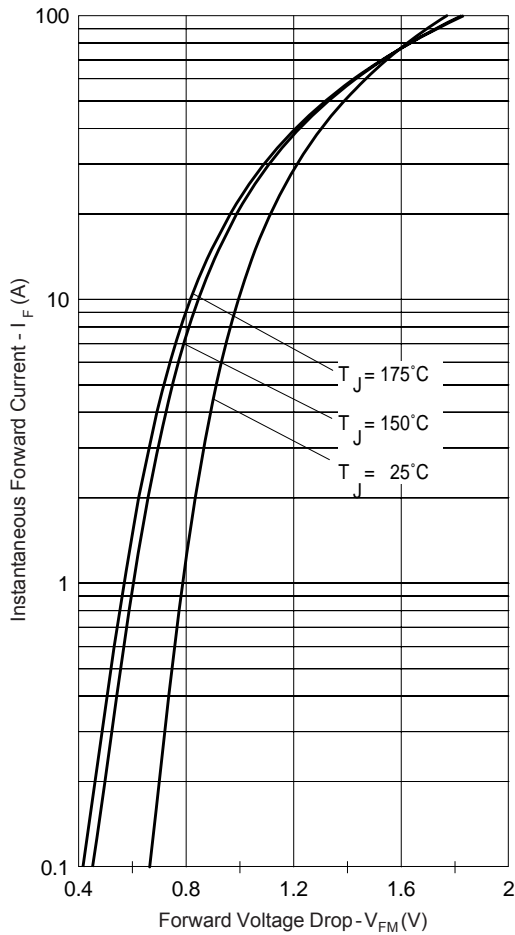

Fig. 1 - Typical Forward Voltage Drop Characteristics

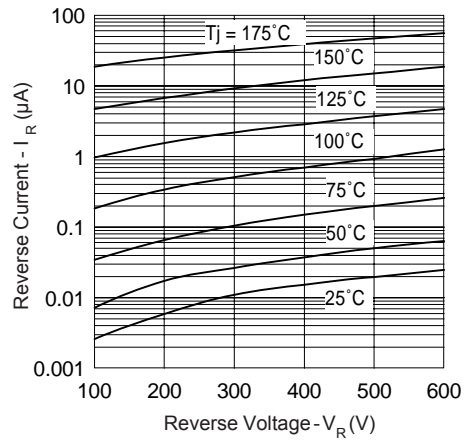

Fig. 2 - Typical Values Of Reverse Current Vs. Reverse Voltage

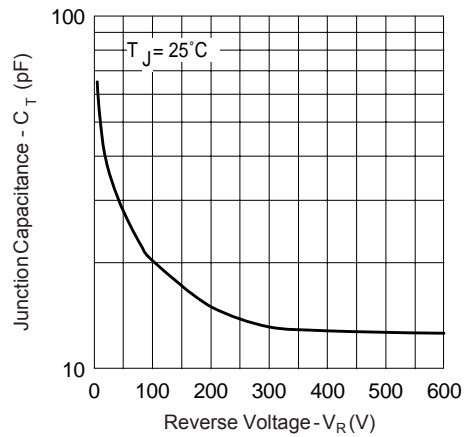

Fig. 3 - Typical Junction Capacitance Vs. Reverse Voltage

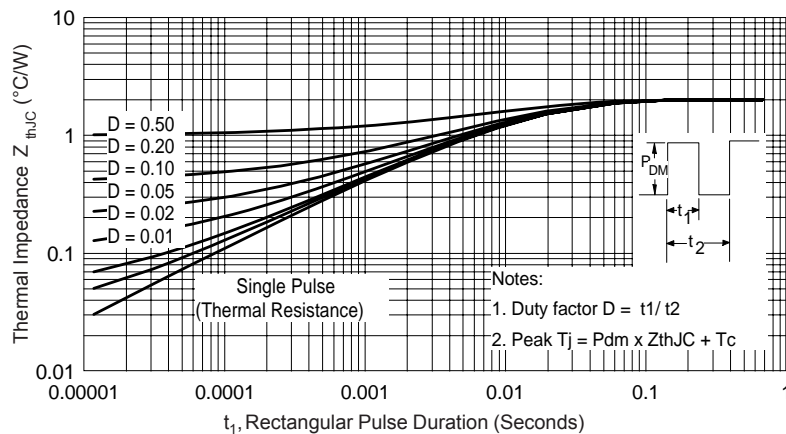

Fig. 4 - Max. Thermal Impedance Z_{thJC} Characteristics

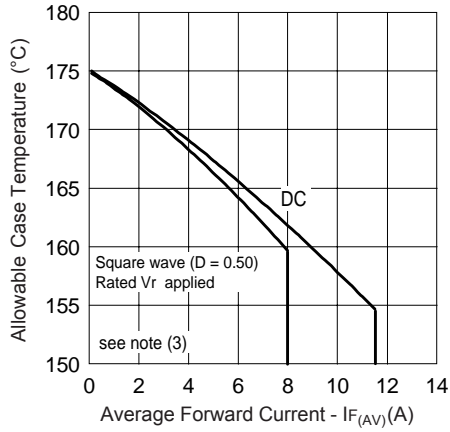

Fig. 5 - Max. Allowable Case Temperature Vs. Average Forward Current

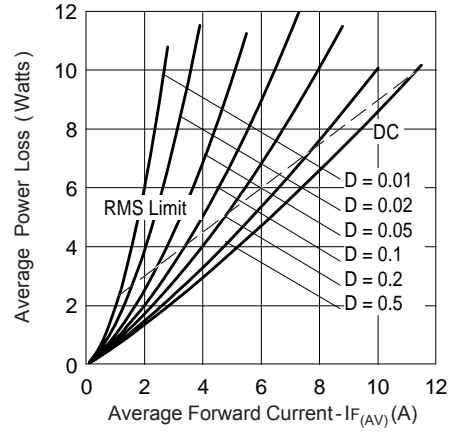

Fig. 6 - Forward Power Loss Characteristics

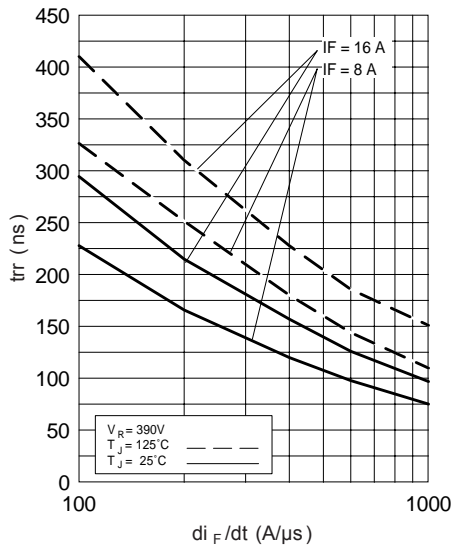

Fig. 7 - Typical Reverse Recovery vs. di_F/dt

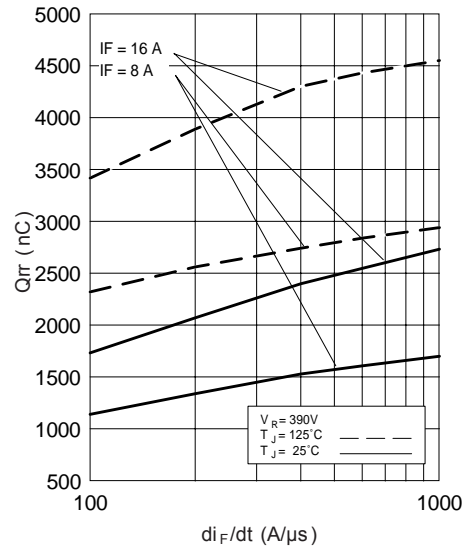

Fig. 8 - Typical Stored Charge vs. di_F/dt

(3) Formula used: $T_C = T_J - (Pd + Pd_{REV}) \times R_{thJC}$; Pd = Forward Power Loss = $I_{F(AV)} \times V_{FM} @ (I_{F(AV)} / D)$ (see Fig. 8);
 Pd_{REV} = Inverse Power Loss = $V_{R1} \times I_{R1} (1 - D)$; $I_{R1} @ V_{R1}$ = rated V_R

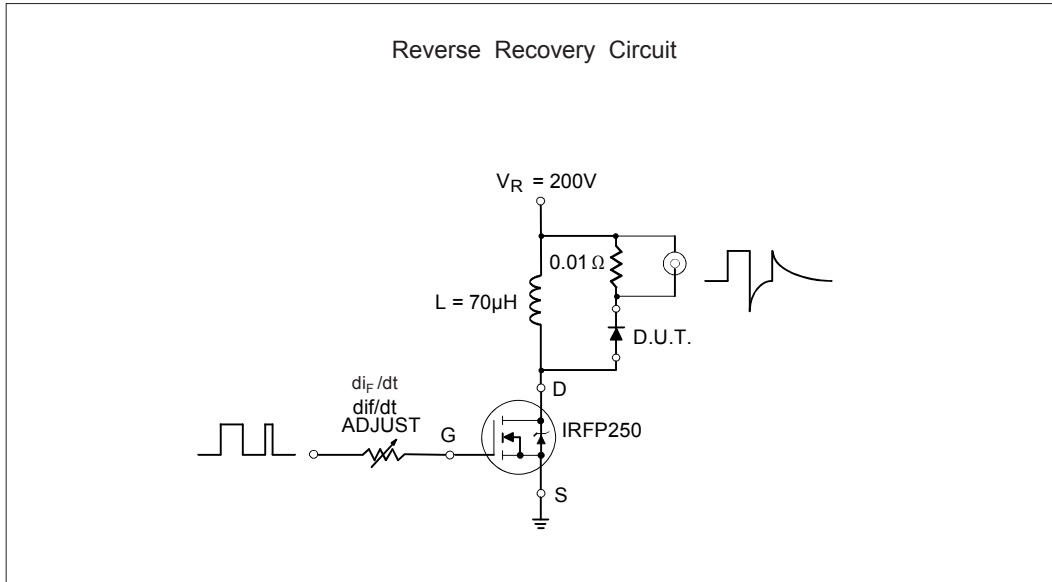

Fig. 9- Reverse Recovery Parameter Test Circuit

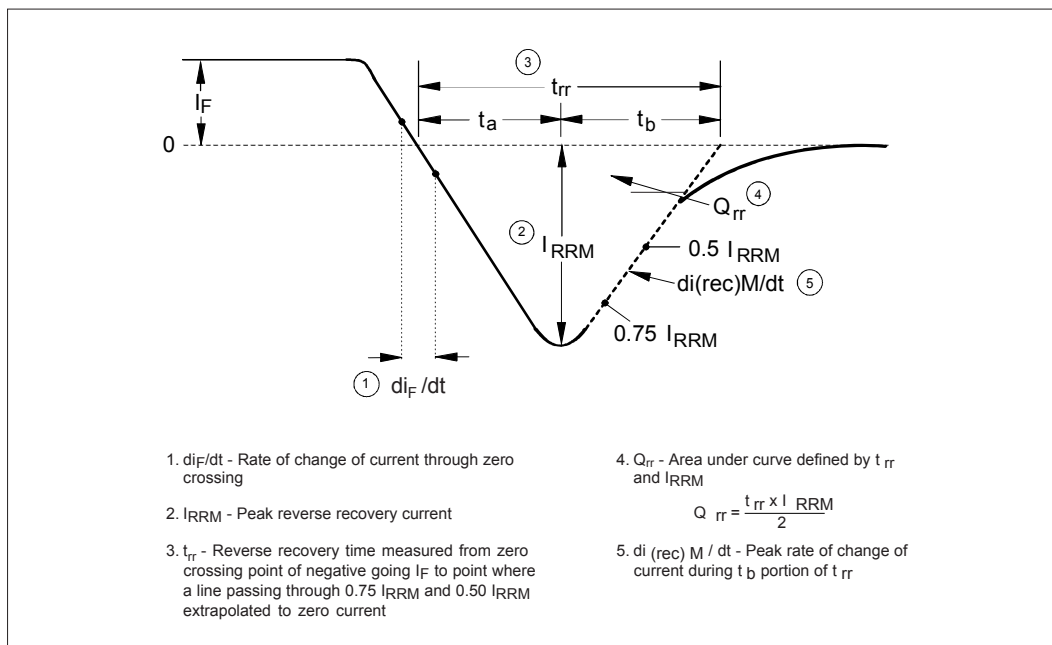
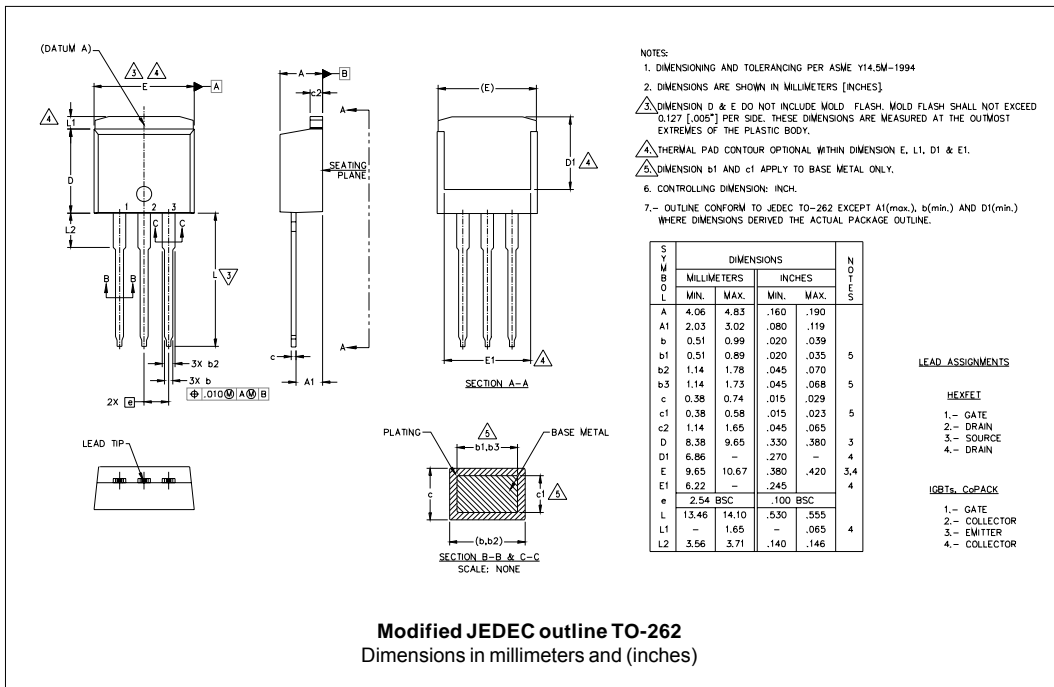
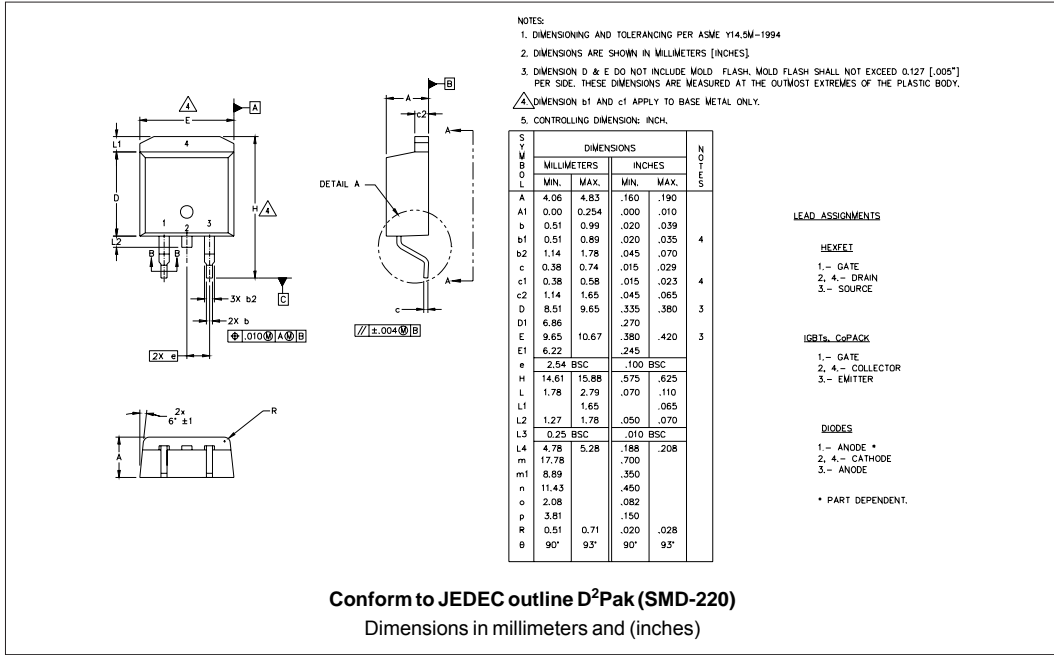
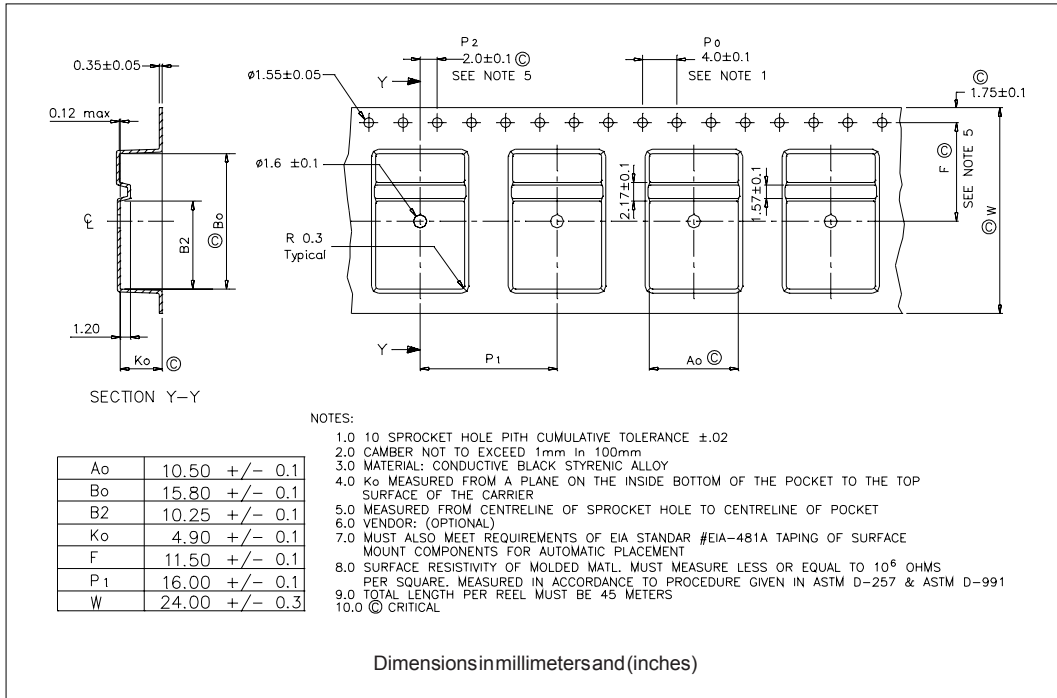

Fig. 10 - Reverse Recovery Waveform and Definitions

Outline Table



Tape & Reel Information



Part Marking Information

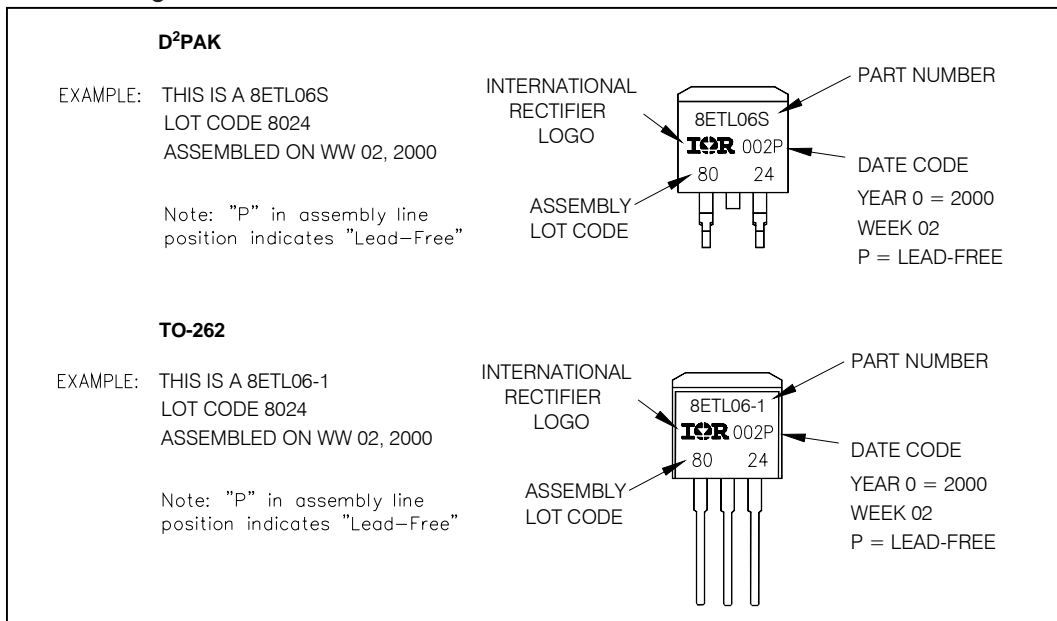

Ordering Information Table

Device Code							
	8	E	T	L	06	S	TRL PbF
	①	②	③	④	⑤	⑥	⑦
1	-	Current Rating (8A)					
2	-	E = Single Diode					
3	-	T = TO-220, D ² Pak					
4	-	L = Ultra-low V _F HyperFast Recovery					
5	-	Voltage Rating (06 = 600V)					
6	-	<ul style="list-style-type: none"> • S = D²Pak • -1 = TO-262 					
7	-	<ul style="list-style-type: none"> • none = Tube (50 pieces) • TRL = Tape & Reel (Left Oriented, for D²PAK package) • TRR = Tape & Reel (Right Oriented, for D²PAK package) 					
8	-	<ul style="list-style-type: none"> • none = Standard Production • PbF = Lead-Free 					

Data and specifications subject to change without notice.
 This product has been designed and qualified for Industrial Level and Lead-Free.
 Qualification Standards can be found on IR's Web site.