

General Description

The AAT7361 is a low threshold dual P-channel MOSFET designed for the battery, cell phone, and PDA markets. Using AnalogicTech's ultra-high-density MOSFET process and space-saving, small-outline, J-lead package, performance superior to that normally found in a larger footprint has been squeezed into the footprint of a TSOPJW8 package.

Applications

- Battery Packs
- Battery-Powered Portable Equipment
- Cellular and Cordless Telephones

Absolute Maximum Ratings

$T_A = 25^\circ\text{C}$, unless otherwise noted.

Symbol	Description	Value	Units	
V_{DS}	Drain-Source Voltage	-20	V	
V_{GS}	Gate-Source Voltage	± 12		
I_D	Continuous Drain Current @ $T_J = 150^\circ\text{C}^1$	$T_A = 25^\circ\text{C}$	± 3.0	A
		$T_A = 70^\circ\text{C}$	± 2.4	
I_{DM}	Pulsed Drain Current ²	± 9		
I_S	Continuous Source Current (Source-Drain Diode) ¹	-1.0		
T_J	Operating Junction Temperature Range	-55 to 150	$^\circ\text{C}$	
T_{STG}	Storage Temperature Range	-55 to 150	$^\circ\text{C}$	

Features

- Drain-Source Voltage (max): -20V
- Continuous Drain Current¹ (max) -3.0A @ 25°C
- Low On-Resistance:
 - $100\text{m}\Omega$ @ $V_{GS} = -4.5\text{V}$
 - $175\text{m}\Omega$ @ $V_{GS} = -2.5\text{V}$

Dual TSOPJW-8 Package

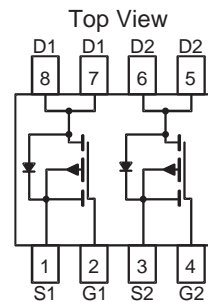

Thermal Characteristics¹

Symbol	Description	Typ	Max	Units
$R_{\theta JA}$	Junction-to-Ambient Steady State, One FET On	124	155	$^\circ\text{C}/\text{W}$
$R_{\theta JA2}$	Junction-to-Ambient $t < 5$ Seconds	74	90	$^\circ\text{C}/\text{W}$
$R_{\theta JF}$	Junction-to-Foot	66	80	$^\circ\text{C}/\text{W}$
P_D	Maximum Power Dissipation	$T_A = 25^\circ\text{C}$	1.4	W
		$T_A = 70^\circ\text{C}$	0.9	

1. Based on thermal dissipation from junction to ambient while mounted on a 1" x 1" PCB with optimized layout. A 5-second pulse on a 1" x 1" PCB approximates testing a device mounted on a large multi-layer PCB as in most applications. $R_{\theta JF} + R_{\theta FA} = R_{\theta JA}$ where the foot thermal reference is defined as the normal solder mounting surface of the device's leads. $R_{\theta JF}$ is guaranteed by design; however, $R_{\theta CA}$ is determined by the PCB design. Actual maximum continuous current is limited by the application's design.

2. Pulse test: Pulse Width = 300 μs .

Electrical Characteristics

$T_J = 25^\circ\text{C}$, unless otherwise noted.

Symbol	Description	Conditions	Min	Typ	Max	Units
DC Characteristics						
BV_{DSS}	Drain-Source Breakdown Voltage	$V_{GS} = 0V, I_D = -250\mu A$	-20			V
$R_{DS(ON)}$	Drain-Source On-Resistance ¹	$V_{GS} = -4.5V, I_D = -3.0A$		80	100	m Ω
		$V_{GS} = -2.5V, I_D = -2.3A$		140	175	
$I_{D(ON)}$	On-State Drain Current ¹	$V_{GS} = -4.5V, V_{DS} = -5V$ (pulsed)	-9			A
$V_{GS(th)}$	Gate Threshold Voltage	$V_{GS} = V_{DS}, I_D = -250\mu A$	-0.6			V
I_{GSS}	Gate-Body Leakage Current	$V_{GS} = \pm 12V, V_{DS} = 0V$			± 100	nA
I_{DSS}	Drain Source Leakage Current	$V_{GS} = 0V, V_{DS} = -20V$			-1	μA
		$V_{GS} = 0V, V_{DS} = -16V, T_J = 70^\circ\text{C}^2$			-5	
g_{fs}	Forward Transconductance ¹	$V_{DS} = -5V, I_D = -3.0A$		5		S
Dynamic Characteristics²						
Q_G	Total Gate Charge	$V_{DS} = -10V, R_D = 3.3\Omega, V_{GS} = -4.5V$		6		nC
Q_{GS}	Gate-Source Charge	$V_{DS} = -10V, R_D = 3.3\Omega, V_{GS} = -4.5V$		1.3		
Q_{GD}	Gate-Drain Charge	$V_{DS} = -10V, R_D = 3.3\Omega, V_{GS} = -4.5V$		1.7		
$t_{D(ON)}$	Turn-On Delay	$V_{DS} = -10V, R_D = 3.3\Omega, V_{GS} = -4.5V, R_G = 6\Omega$		7		ns
t_R	Turn-On Rise Time	$V_{DS} = -10V, R_D = 3.3\Omega, V_{GS} = -4.5V, R_G = 6\Omega$		13		
$t_{D(OFF)}$	Turn-Off Delay	$V_{DS} = -10V, R_D = 3.3\Omega, V_{GS} = -4.5V, R_G = 6\Omega$		15		
t_F	Turn-Off Fall Time	$V_{DS} = -10V, R_D = 3.3\Omega, V_{GS} = -4.5V, R_G = 6\Omega$		20		
Source-Drain Diode Characteristics						
V_{SD}	Source-Drain Forward Voltage ¹	$V_{GS} = 0, I_S = -3.0A$			-1.3	V
I_S	Continuous Diode Current ³				-1.0	A

1. Pulse test: Pulse Width = 300 μs .

2. Guaranteed by design. Not subject to production testing.

3. Based on thermal dissipation from junction to ambient while mounted on a 1" x 1" PCB with optimized layout. A 5-second pulse on a 1" x 1" PCB approximates testing a device mounted on a large multi-layer PCB as in most applications. $R_{\theta JF} + R_{\theta FA} = R_{\theta JA}$ where the foot thermal reference is defined as the normal solder mounting surface of the device's leads. $R_{\theta JF}$ is guaranteed by design; however, $R_{\theta CA}$ is determined by the PCB design. Actual maximum continuous current is limited by the application's design.

Typical Characteristics

$T_J = 25^\circ\text{C}$, unless otherwise noted.

Output Characteristics

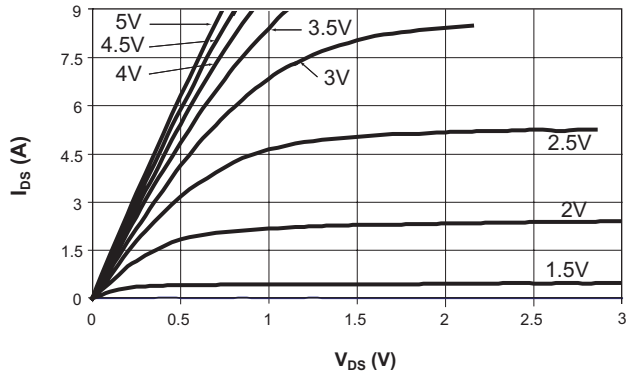

Transfer Characteristics

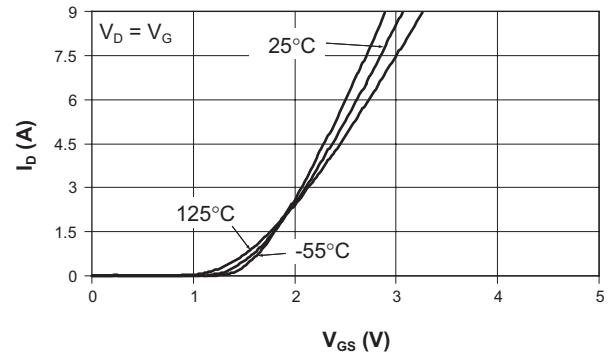

On-Resistance vs. Drain Current

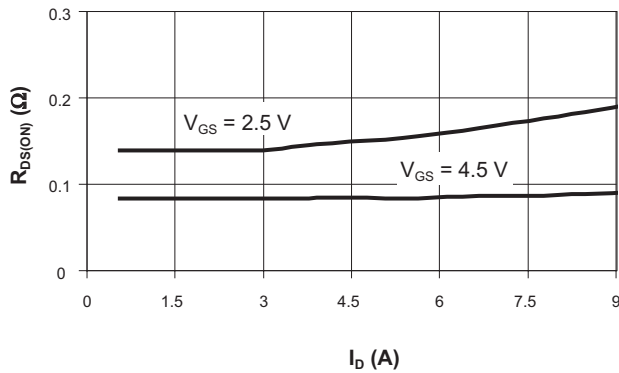

On-Resistance vs. Gate-to-Source Voltage

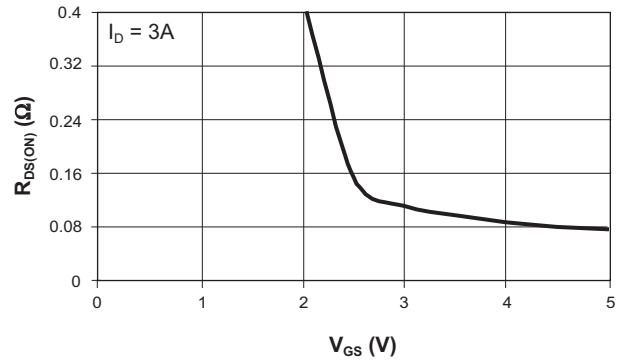

On-Resistance vs. Junction Temperature

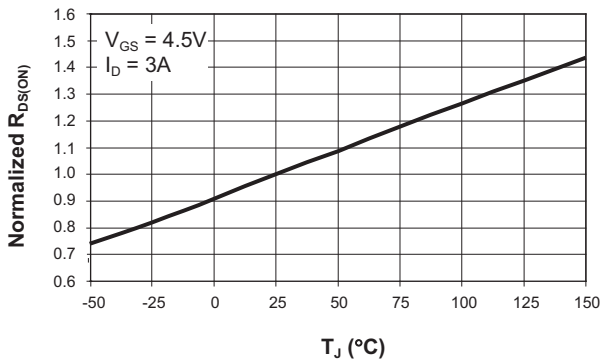

Threshold Voltage

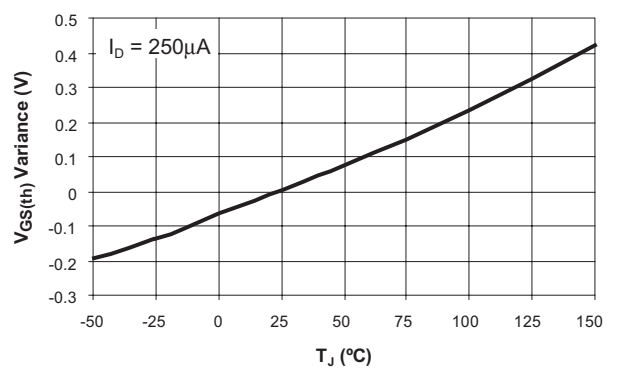

Typical Characteristics

$T_J = 25^\circ\text{C}$, unless otherwise noted.

Gate Charge

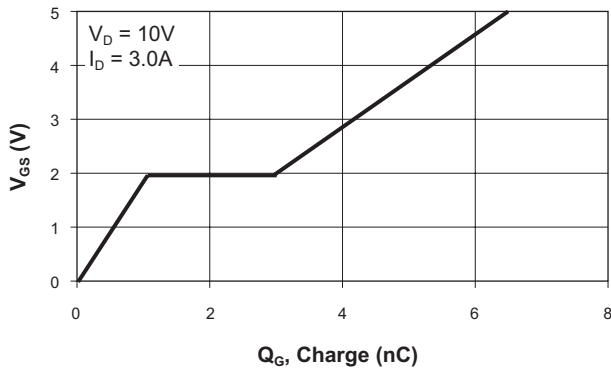

Source-Drain Diode Forward Voltage

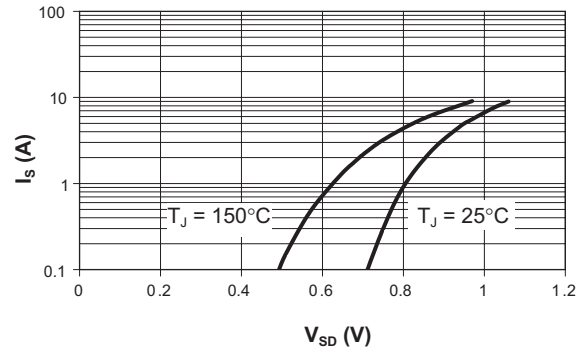

Capacitance

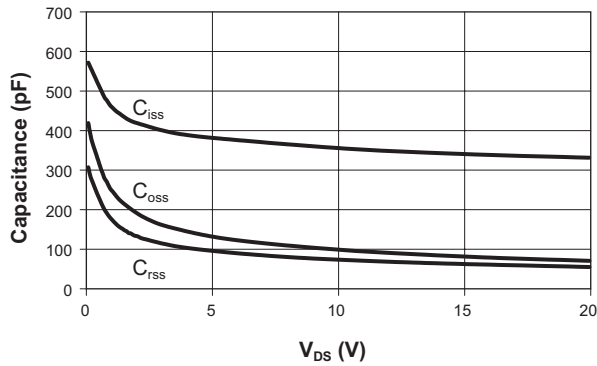

Single Pulse Power, Junction To Ambient

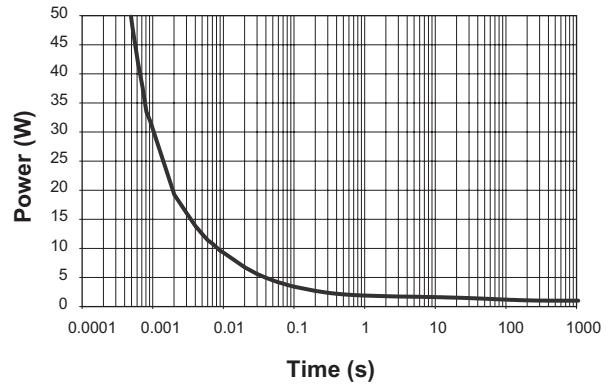

Transient Thermal Response, Junction to Ambient

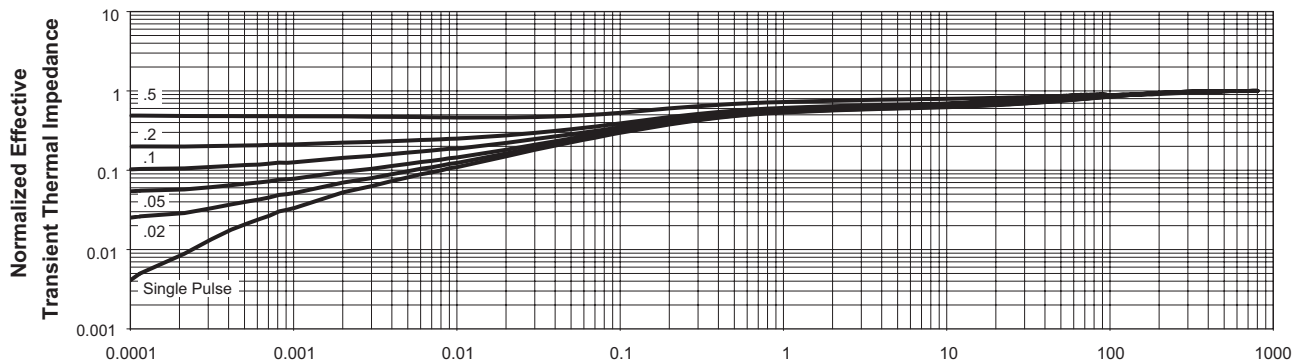

Ordering Information

Package	Marking ¹	Part Number (Tape and Reel) ²
TSOPJW-8	JYXYY	AAT7361ITS-T1

Package Information

TSOPJW-8

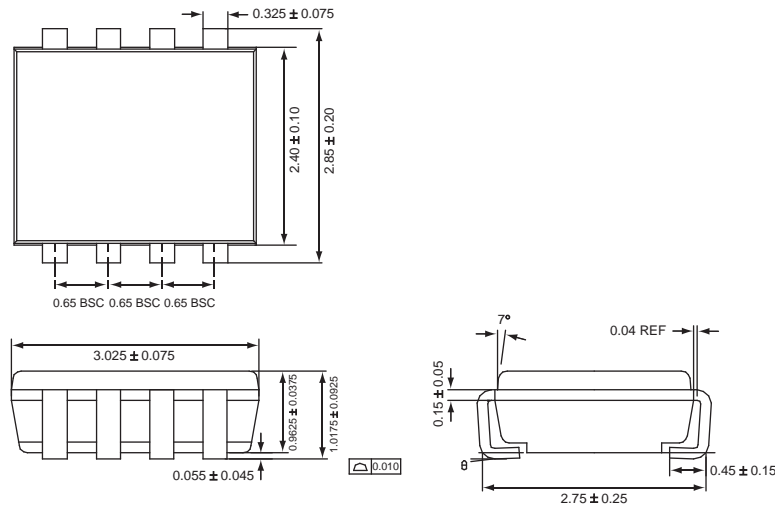

All dimensions in millimeters.

1. XYY = assembly and date code.
 2. Sample stock is generally held on part numbers listed in **BOLD**.

AnalogicTech cannot assume responsibility for use of any circuitry other than circuitry entirely embodied in an AnalogicTech product. No circuit patent licenses, copyrights, mask work rights, or other intellectual property rights are implied.

AnalogicTech reserves the right to make changes to their products or specifications or to discontinue any product or service without notice, and advise customers to obtain the latest version of relevant information to verify, before placing orders, that information being relied on is current and complete. All products are sold subject to the terms and conditions of sale supplied at the time of order acknowledgement, including those pertaining to warranty, patent infringement, and limitation of liability.

AnalogicTech warrants performance of its semiconductor products to the specifications applicable at the time of sale in accordance with AnalogicTech's standard warranty. Testing and other quality control techniques are utilized to the extent AnalogicTech deems necessary to support this warranty. Specific testing of all parameters of each device is not necessarily performed.

Advanced Analogic Technologies, Inc.
830 E. Arques Avenue, Sunnyvale, CA 94085
Phone (408) 737-4600
Fax (408) 737-4611