

PRELIMINARY SPEC

Part Number: APBDA3020CGKSYKC

Green
Super Bright Yellow

Features

- 3.0mmx2.0mm SMT LED, 2.8mm THICKNESS.
- LOW POWER CONSUMPTION.
- VARIOUS COLORS AND LENS TYPES AVAILABLE.
- IDEAL FOR BACK LIGHT AND INDICATOR
- PACKAGE : 2000PCS / REEL.
- WHEN SOLDERED IN THE SIDEVIEW CONFIGURATION, THE MAXIMUM SHEAR TOLERANCE OF THE EPOXY LENS IS 300G.
- MOISTURE SENSITIVITY LEVEL : LEVEL 3.
- RoHS COMPLIANT.

Description

The Green source color devices are made with InGaAlP on GaAs substrate Light Emitting Diode.
The Super Bright Yellow device is made with DH InGaAlP (on GaAs substrate) light emitting diode chip.

Package Dimensions

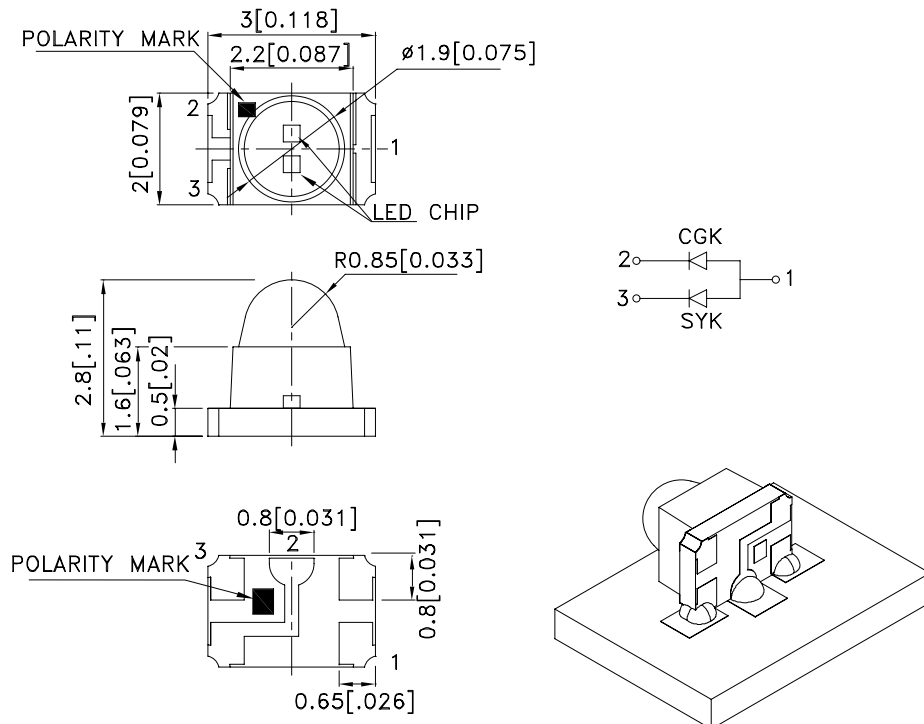

Notes:

1. All dimensions are in millimeters (inches).
2. Tolerance is ± 0.2 (0.008") unless otherwise noted.
3. Specifications are subject to change without notice.
4. The device has a single mounting surface. The device must be mounted according to the specifications.



Selection Guide

Part No.	Dice	Lens Type	Iv (mcd) [2] @ 20mA		Viewing Angle [1]
			Min.	Typ.	2θ1/2
APBDA3020CGKSYKC	Green (InGaAlP)	WATER CLEAR	180	320	15°
	Super Bright Yellow (InGaAlP)		480	750	

Notes:

1. θ1/2 is the angle from optical centerline where the luminous intensity is 1/2 the optical centerline value.
2. Luminous intensity/ Luminous Flux: +/-15%.

Electrical / Optical Characteristics at TA=25°C

Symbol	Parameter	Device	Typ.	Max.	Units	Test Conditions
λ _{peak}	Peak Wavelength	Green Super Bright Yellow	574 590		nm	I _F =20mA
λ _D [1]	Dominant Wavelength	Green Super Bright Yellow	570 590		nm	I _F =20mA
Δλ _{1/2}	Spectral Line Half-width	Green Super Bright Yellow	20 20		nm	I _F =20mA
C	Capacitance	Green Super Bright Yellow	15 20		pF	V _F =0V;f=1MHz
V _F [2]	Forward Voltage	Green Super Bright Yellow	2.1 2	2.5 2.5	V	I _F =20mA
I _R	Reverse Current	Green Super Bright Yellow		10 10	μA	V _R = 5V

Notes:

1. Wavelength: +/-1nm.
2. Forward Voltage: +/-0.1V.

Absolute Maximum Ratings at TA=25°C

Parameter	Green	Super Bright Yellow	Units
Power dissipation	75	75	mW
DC Forward Current	30	30	mA
Peak Forward Current [1]	150	175	mA
Reverse Voltage	5		V
Operating Temperature	-40°C To +85°C		
Storage Temperature	-40°C To +85°C		

Note:

1. 1/10 Duty Cycle, 0.1ms Pulse Width.

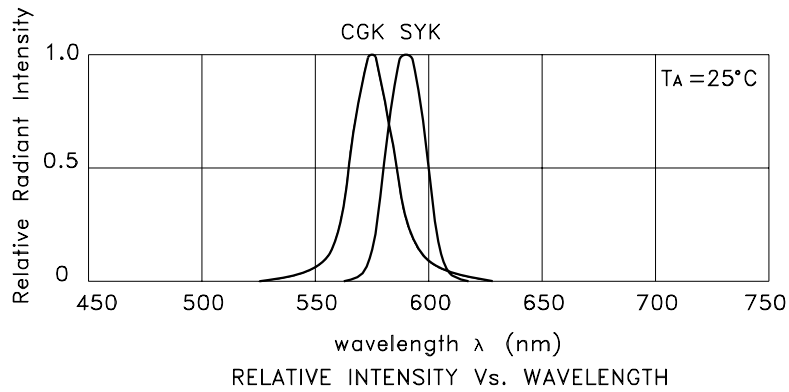

APBDA3020CGKSYKC
Green

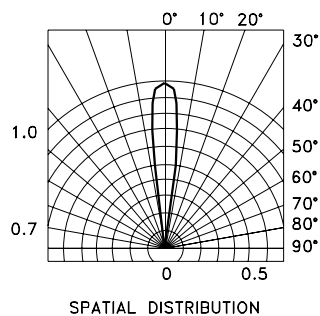
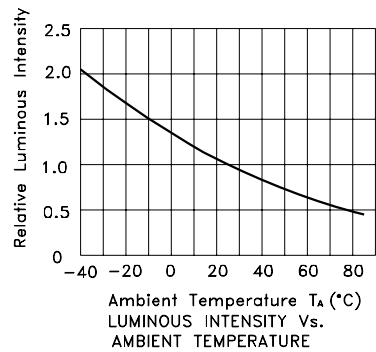
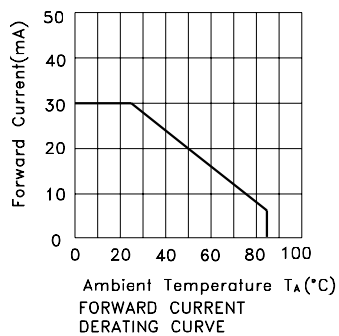
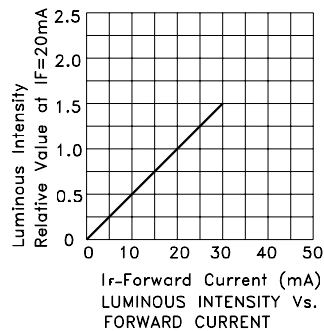
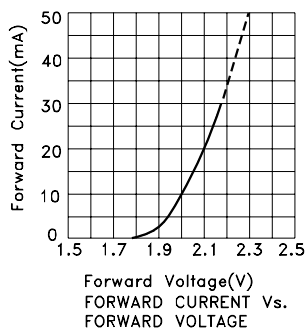

Kingbright

Super Bright Yellow

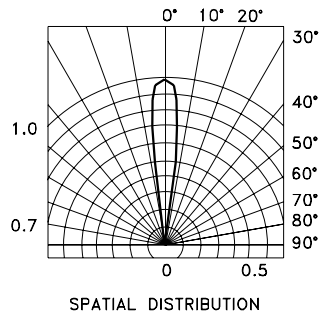
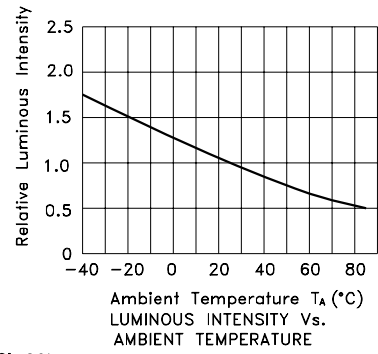
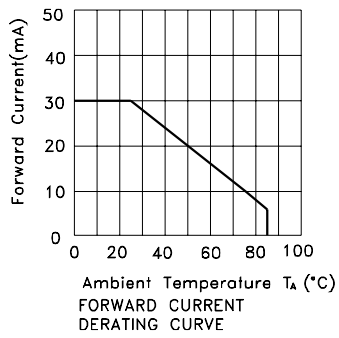
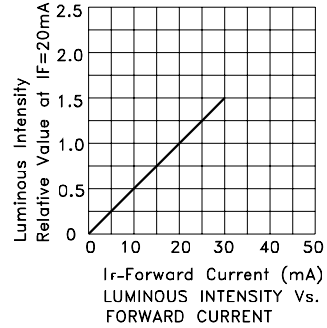
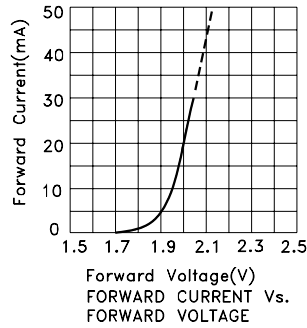

Kingbright

PACKING & LABEL SPECIFICATIONS

APBDA3020CGKSYKC

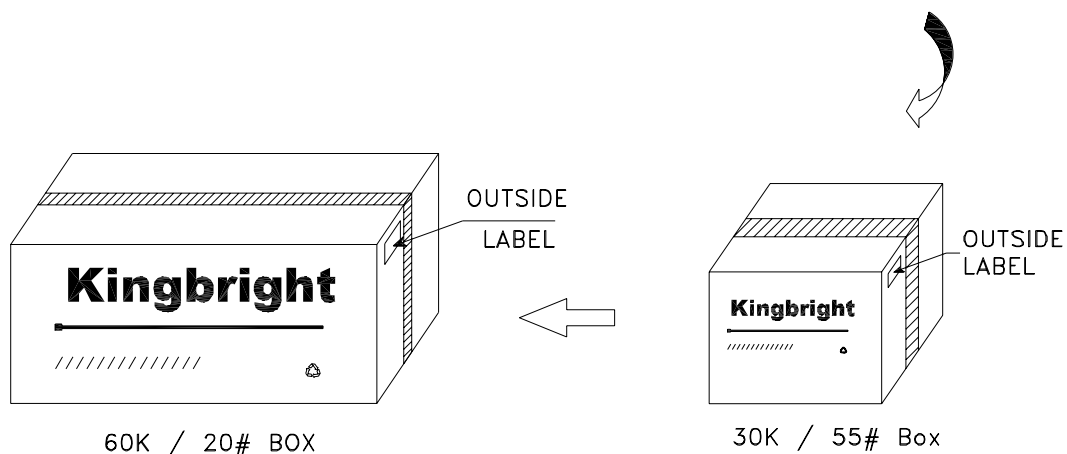
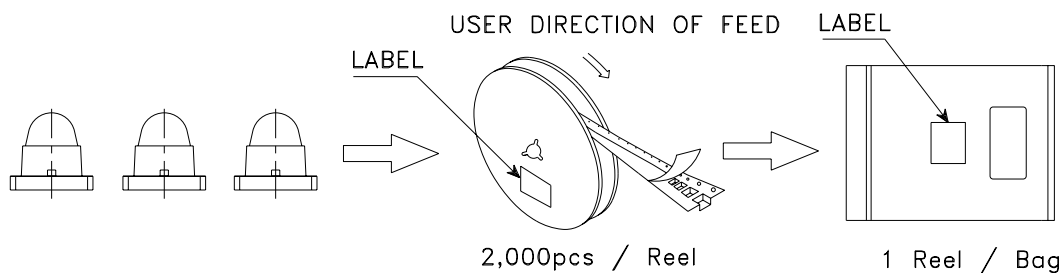

<h1>Kingbright</h1>	
P/NO: APBDA3020xxx	
QTY: 2,000 pcs	Q.C. Q C xx xx xxxx PASSED
S/N: XXXX	
CODE: XXX	
LOT NO:	
 xxxxxxxxxxxxxxxxxxxxxxxxxxxx	
RoHS Compliant	