

**Single switch
Series & parallel diodes
MOSFET Power Module**

**$V_{DSS} = 1000V$
 $R_{DSon} = 130m\Omega$ typ @ $T_j = 25^\circ C$
 $I_D = 65A$ @ $T_c = 25^\circ C$**

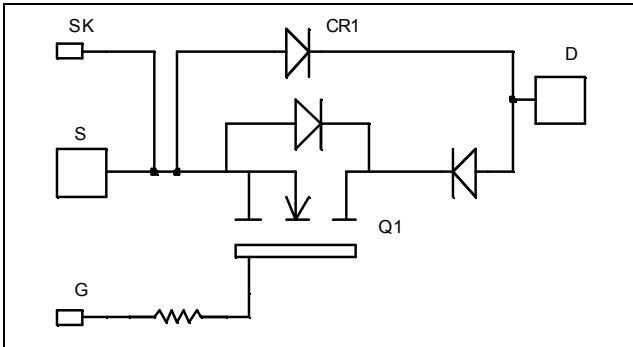

Application

- Motor control
- Switched Mode Power Supplies
- Uninterruptible Power Supplies

Features

- Power MOS V[®] MOSFETs
 - Low R_{DSon}
 - Low input and Miller capacitance
 - Low gate charge
 - Avalanche energy rated
 - Very rugged
- Kelvin source for easy drive
- Very low stray inductance

Benefits

- Outstanding performance at high frequency operation
- Direct mounting to heatsink (isolated package)
- Low junction to case thermal resistance

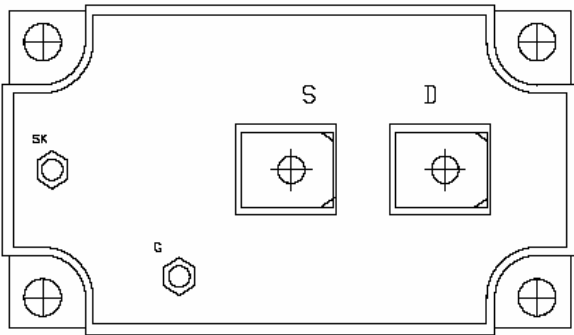

Absolute maximum ratings

Symbol	Parameter	Max ratings	Unit
V_{DSS}	Drain - Source Breakdown Voltage	1000	V
I_D	Continuous Drain Current	$T_c = 25^\circ C$	65
		$T_c = 80^\circ C$	48
I_{DM}	Pulsed Drain current	260	A
V_{GS}	Gate - Source Voltage	± 30	V
R_{DSon}	Drain - Source ON Resistance	145	$m\Omega$
P_D	Maximum Power Dissipation	$T_c = 25^\circ C$	1250
I_{AR}	Avalanche current (repetitive and non repetitive)	17	A
E_{AR}	Repetitive Avalanche Energy	50	mJ
E_{AS}	Single Pulse Avalanche Energy	2500	

CAUTION: These Devices are sensitive to Electrostatic Discharge. Proper Handling Procedures Should Be Followed.

All ratings @ $T_j = 25^\circ\text{C}$ unless otherwise specified

Electrical Characteristics

Symbol	Characteristic	Test Conditions	Min	Typ	Max	Unit
I_{DSS}	Zero Gate Voltage Drain Current	$V_{GS} = 0V, V_{DS} = 1000V$			100	μA
		$T_j = 25^\circ\text{C}$				
$R_{DS(on)}$	Drain – Source on Resistance	$V_{GS} = 0V, V_{DS} = 800V$			400	$\text{m}\Omega$
		$T_j = 125^\circ\text{C}$				
$R_{DS(on)}$	Drain – Source on Resistance	$V_{GS} = 10V, I_D = 32.5A$		130	145	$\text{m}\Omega$
$V_{GS(th)}$	Gate Threshold Voltage	$V_{GS} = V_{DS}, I_D = 10\text{mA}$	2		4	V
I_{CSS}	Gate – Source Leakage Current	$V_{GS} = \pm 30V, V_{DS} = 0V$			± 200	nA

Dynamic Characteristics

Symbol	Characteristic	Test Conditions	Min	Typ	Max	Unit
C_{iss}	Input Capacitance	$V_{GS} = 0V$		26.4	31.6	nF
C_{oss}	Output Capacitance	$V_{DS} = 25V$		2.38	3.32	
C_{rss}	Reverse Transfer Capacitance	$f = 1\text{MHz}$		1.16	1.72	
Q_g	Total gate Charge	$V_{GS} = 10V$ $V_{Bus} = 500V$ $I_D = 65A$		1340	2000	nC
Q_{gs}	Gate – Source Charge			116	180	
Q_{gd}	Gate – Drain Charge			660	1000	
$T_{d(on)}$	Turn-on Delay Time	Inductive Switching @ 25°C $V_{GS} = 15V$ $V_{Bus} = 667V$ $I_D = 65A$ $R_G = 1.5\Omega$		20		ns
T_r	Rise Time			20		
$T_{d(off)}$	Turn-off Delay Time			125		
T_f	Fall Time			40		
E_{on}	Turn-on Switching Energy	Inductive switching @ 25°C $V_{GS} = 15V, V_{Bus} = 667V$ $I_D = 65A, R_G = 1.5\Omega$		2.6		μJ
E_{off}	Turn-off Switching Energy			1.6		
E_{on}	Turn-on Switching Energy	Inductive switching @ 125°C $V_{GS} = 15V, V_{Bus} = 667V$ $I_D = 65A, R_G = 1.5\Omega$		4.2		μJ
E_{off}	Turn-off Switching Energy			1.82		
R_{thJC}	Junction to Case				0.1	$^\circ\text{C/W}$

Series diode ratings and characteristics

Symbol	Characteristic	Test Conditions	Min	Typ	Max	Unit
V_{RRM}	Maximum Peak Repetitive Reverse Voltage		200			V
I_{RM}	Maximum Reverse Leakage Current	$V_R = 200V$	$T_j = 25^\circ\text{C}$		350	μA
			$T_j = 125^\circ\text{C}$		600	
$I_{F(AV)}$	Maximum Average Forward Current	50% duty cycle		120		A
V_F	Diode Forward Voltage	$I_F = 120A$		1.1	1.15	V
		$I_F = 240A$		1.4		
		$I_F = 120A$	$T_j = 125^\circ\text{C}$		0.9	
t_{rr}	Reverse Recovery Time	$I_F = 120A$ $V_R = 133V$	$T_j = 25^\circ\text{C}$		31	ns
			$T_j = 125^\circ\text{C}$		60	
Q_{rr}	Reverse Recovery Charge	$di/dt = 400A/\mu\text{s}$	$T_j = 25^\circ\text{C}$		120	nC
			$T_j = 125^\circ\text{C}$		500	
R_{thJC}	Junction to Case				0.46	$^\circ\text{C/W}$

Parallel diode ratings and characteristics

Symbol	Characteristic	Test Conditions	Min	Typ	Max	Unit
V _{RRM}	Maximum Peak Repetitive Reverse Voltage		1000			V
I _{RM}	Maximum Reverse Leakage Current	V _R =1000V			250 500	μA
I _{F(AV)}	Maximum Average Forward Current	50% duty cycle		100		A
V _F	Diode Forward Voltage	I _F = 100A		1.9	2.5	V
		I _F = 200A		2.2		
		I _F = 100A	T _j = 125°C	1.7		
t _{rr}	Reverse Recovery Time	I _F = 100A V _R = 667V di/dt = 200A/μs	T _j = 25°C	300		ns
			T _j = 125°C	360		
Q _{rr}	Reverse Recovery Charge	di/dt = 200A/μs	T _j = 25°C	800		nC
			T _j = 125°C	4050		
R _{thJC}	Junction to Case				0.6	°C/W

Thermal and package characteristics

Symbol	Characteristic	Min	Typ	Max	Unit
V _{ISOL}	RMS Isolation Voltage, any terminal to case t = 1 min, I _{isol} < 1mA, 50/60Hz	2500			V
T _J	Operating junction temperature range	-40		150	°C
T _{STG}	Storage Temperature Range	-40		125	
T _C	Operating Case Temperature	-40		100	
Torque	Mounting torque	M4		1.2	N.m
		M6	3	5	
Wt	Package Weight			400	g

J3 Package outline (dimensions in mm)

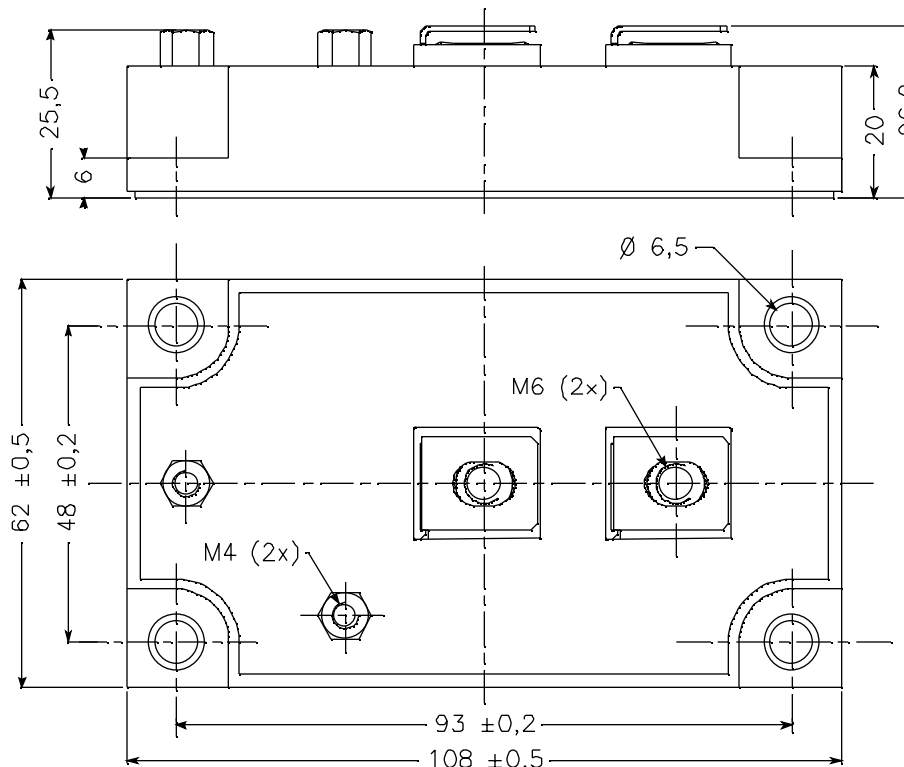

Typical Performance Curve

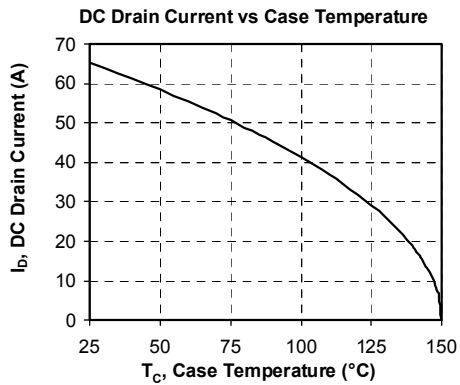
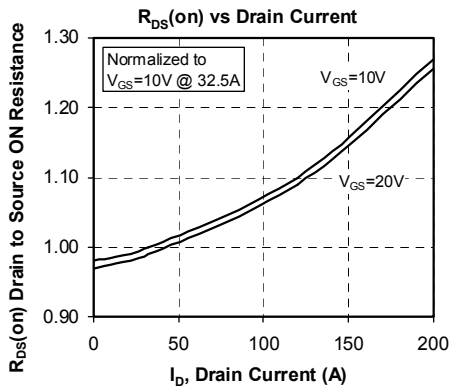
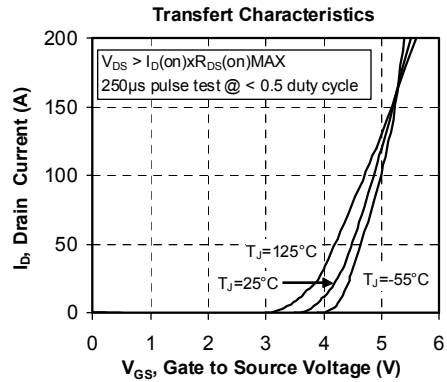
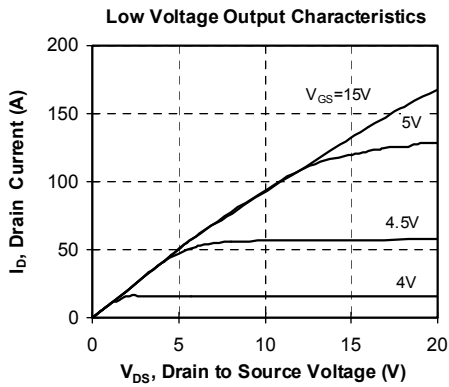
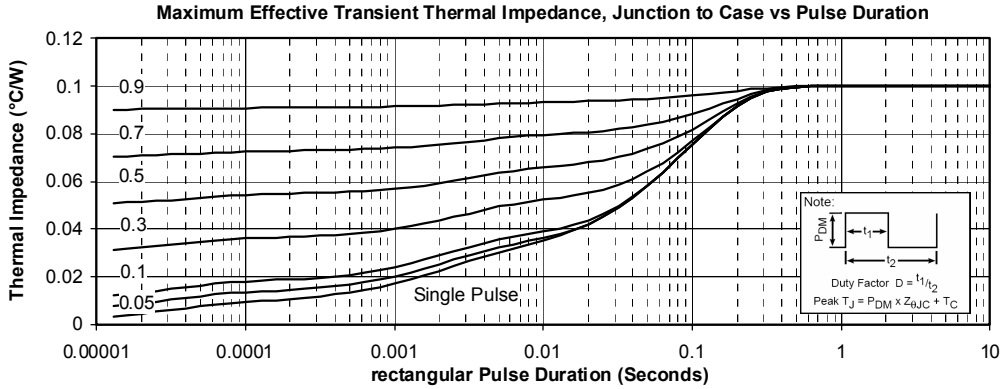

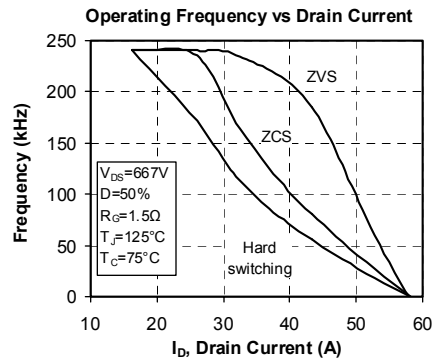
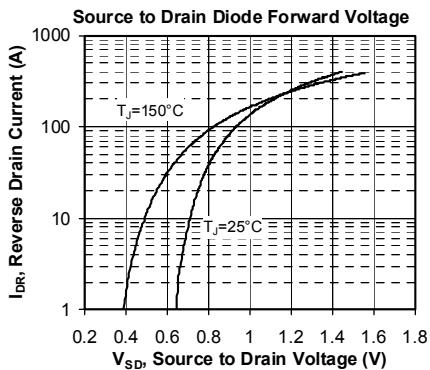
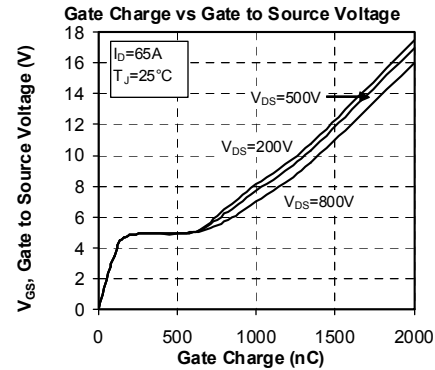
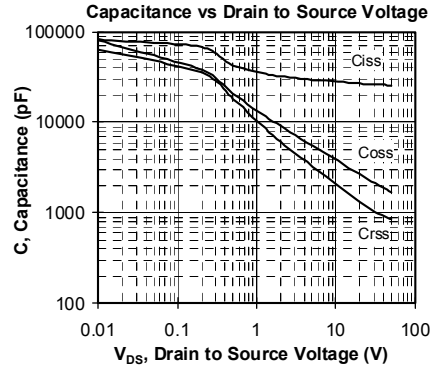
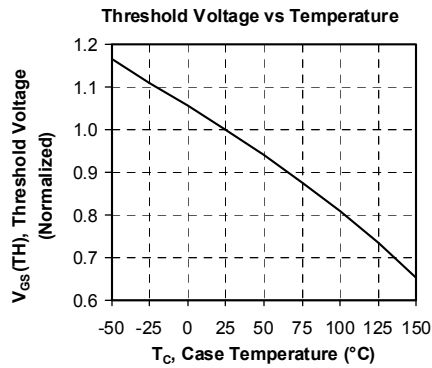
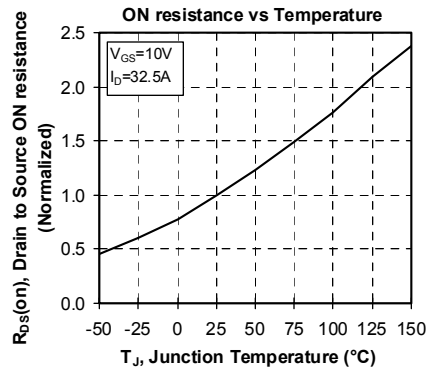
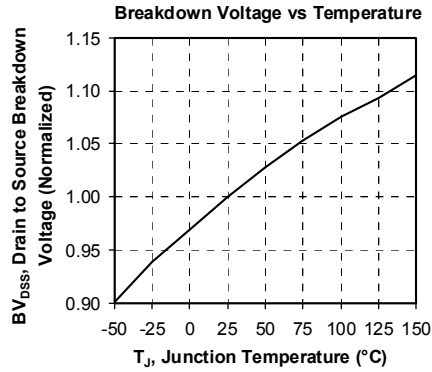

APT reserves the right to change, without notice, the specifications and information contained herein

APT's products are covered by one or more of U.S. patents 4,895,810 5,045,903 5,089,434 5,182,234 5,019,522 5,262,336 6,503,786 5,256,583 4,748,103 5,283,202 5,231,474 5,434,095 5,528,058 and foreign patents. U.S. and Foreign patents pending. All Rights Reserved.