

# SBD Type : C30T03QL

OUTLINE DRAWING

**FEATURES**

- \*SQUARE-PAK TO-263AB(SMD)  
Packaged in 24mm Tape and Reel
- \*Dual Diodes – Cathode Common
- \*Low Forward Voltage Drop
- \*High Surge Capability
- \*T<sub>j</sub>=150 °C operation

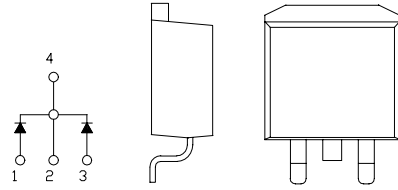

## Maximum Ratings

Approx Net Weight: 1.4g

Rating	Symbol	C30T03QL		Unit
Repetitive Peak Reverse Voltage	V <sub>RRM</sub>	30		V
Repetitive Peak Surge Reverse Voltage	V <sub>RRSM</sub>	35(pulse width ≤ 1μs duty ≤ 1/50)		V
Average Rectified Output Current	I <sub>O</sub>	30	T <sub>c</sub> =105°C 50 Hz Full Sine Wave Resistive Load	A
RMS Forward Current	I <sub>F(RMS)</sub>	33.3		A
Surge Forward Current	I <sub>FSM</sub>	250	50Hz Full Sine Wave ,1cycle Non-repetitive	A
Operating JunctionTemperature Range	T <sub>jw</sub>	-40 to +150		°C
Storage Temperature Range	T <sub>stg</sub>	-40 to +150		°C

## Electrical • Thermal Characteristics

Characteristics	Symbol	Conditions	Min.	Typ.	Max.	Unit
Peak Reverse Current	I <sub>RM</sub>	T <sub>j</sub> = 25°C, V <sub>RM</sub> = V <sub>RRM</sub> per arm	-	-	15	mA
Peak Forward Voltage	V <sub>FM</sub>	T <sub>j</sub> = 25°C, I <sub>FM</sub> = 15A per arm	-	-	0.49	V
Thermal Resistance	R <sub>th(j-c)</sub>	Junction to Case	-	-	1.5	°C /W

C\_T\_ OUTLINE DRAWING (Dimensions in mm)



SOLDERING PAD

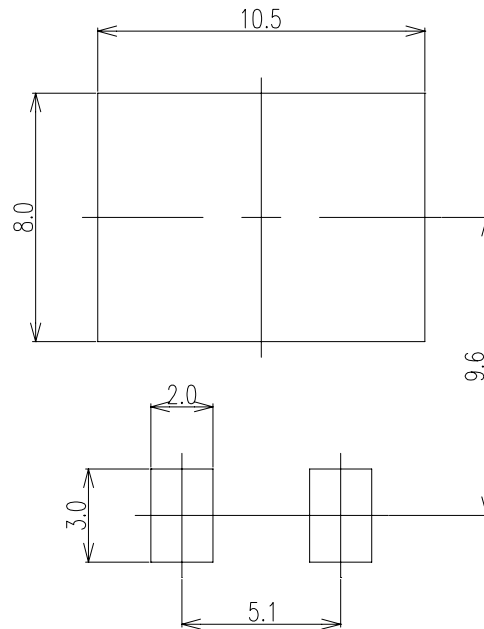

FORWARD CURRENT VS. VOLTAGE

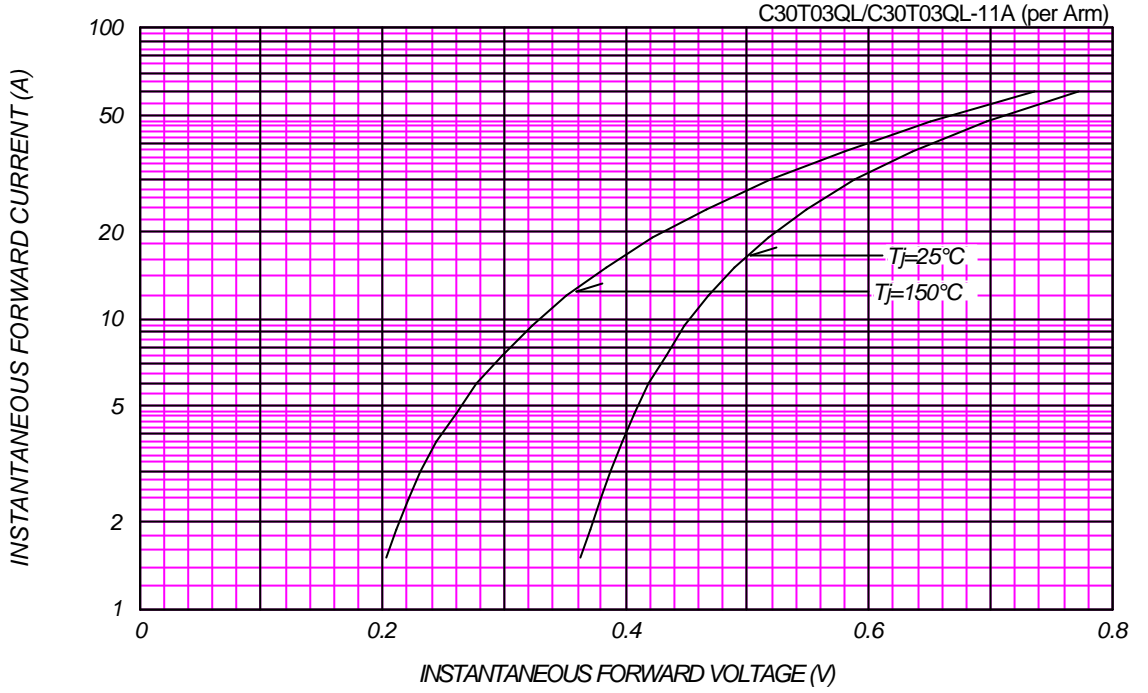

AVERAGE FORWARD POWER DISSIPATION

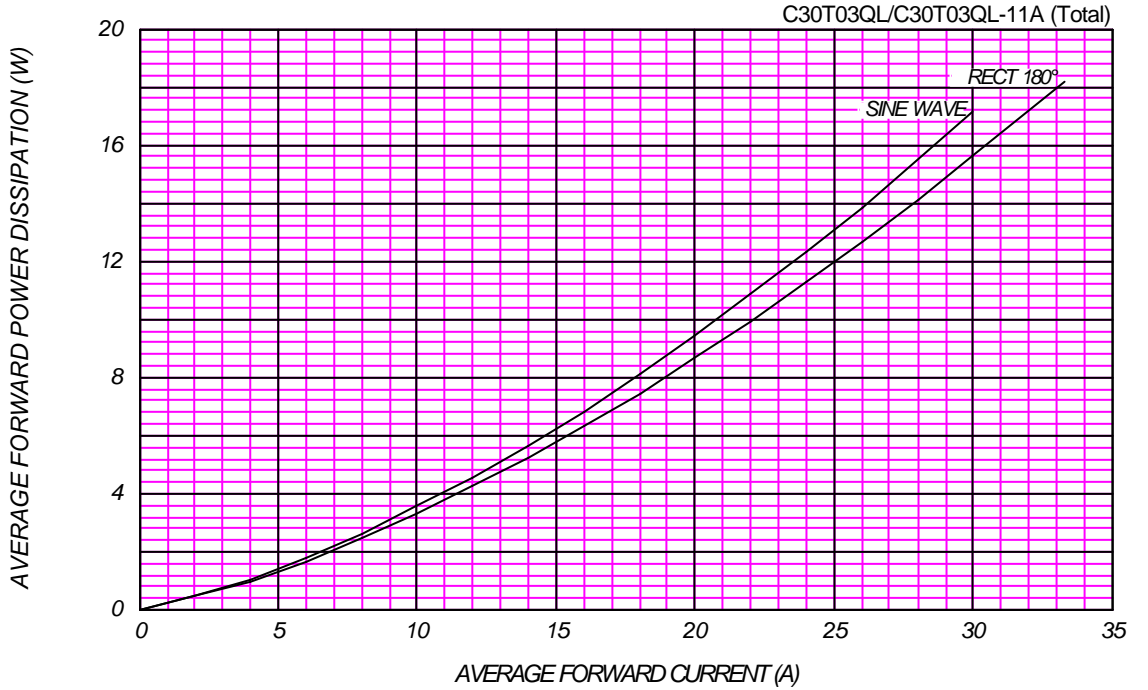

PEAK REVERSE CURRENT VS. PEAK REVERSE VOLTAGE

$T_j = 150\text{ }^\circ\text{C}$

C30T03QL/C30T03QL-11A (per Arm)



AVERAGE REVERSE POWER DISSIPATION

C30T03QL/C30T03QL-11A (Total)

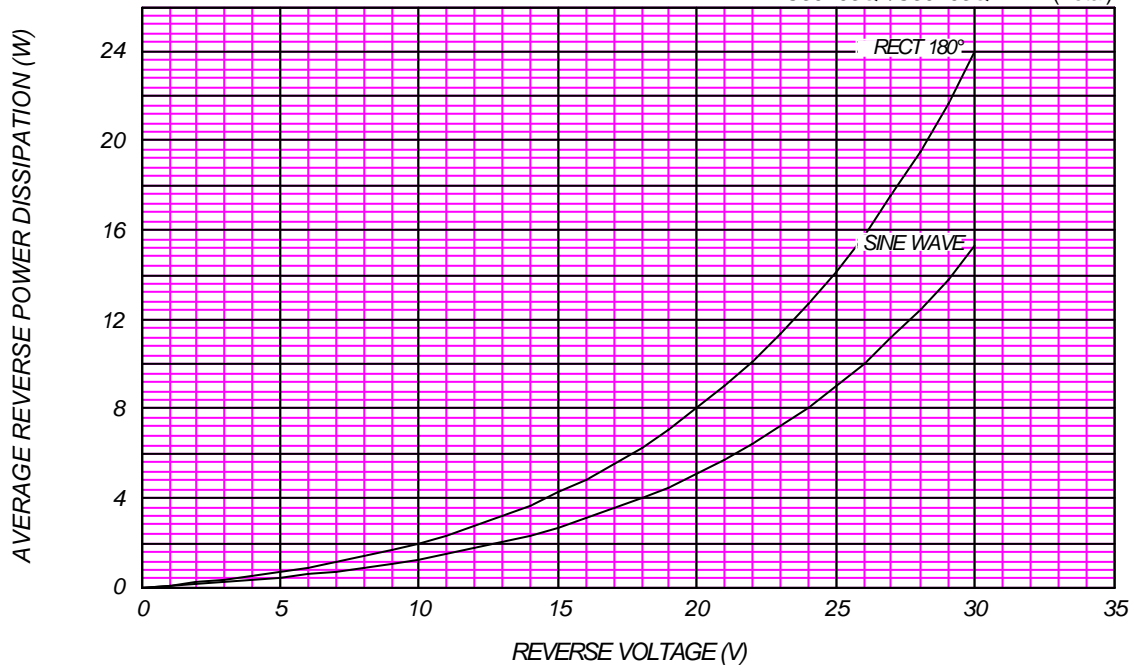



### AVERAGE FORWARD CURRENT VS. CASE TEMPERATURE

$V_{RM}=30V$

C30T03QL/C30T03QL-11A (Total)

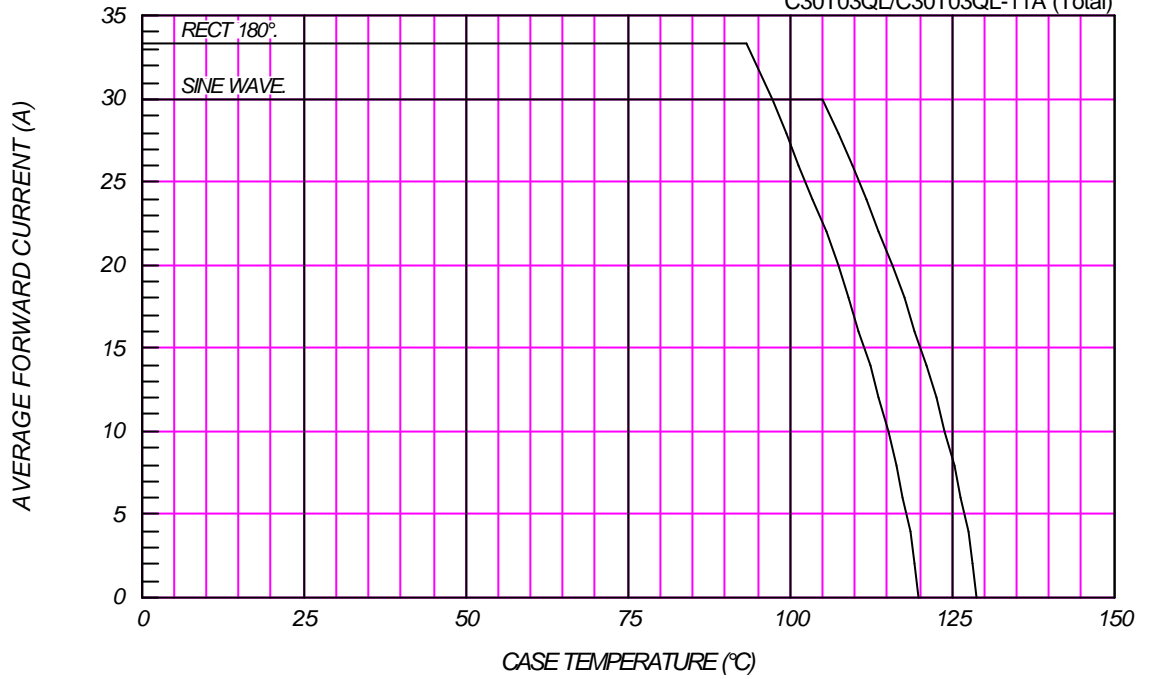

### SURGE CURRENT RATINGS

$f=50Hz$ , Sine Wave, Non-Repetitive, No Load

C30T03QL/C30T03QL-11A

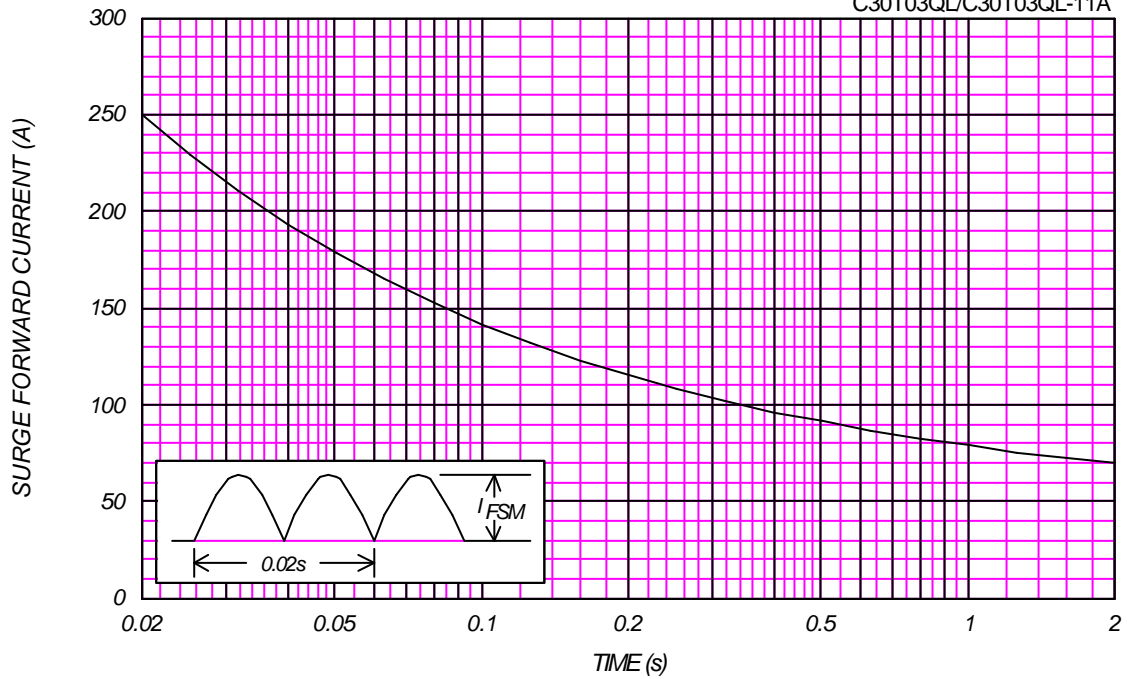

### JUNCTION CAPACITANCE VS. REVERSE VOLTAGE

$T_j=25^\circ\text{C}$ ,  $V_m=20\text{mV}_{\text{RMS}}$ ,  $f=100\text{kHz}$ , Typical Value

C30T03QL/C30T03QL-11A (per Arm)

