

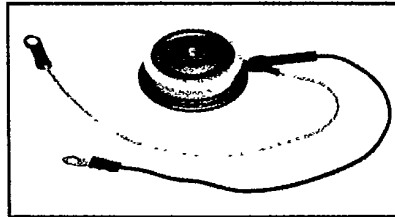

C431

Powerex, Inc. Hillis Street, Youngwood, Pennsylvania 15697 (412) 925-7272
 Powerex Europe, S.A., 428 Ave. G. Durand, BP107, 72003 LeMans, France (43) 72.75.15

Phase Control SCR
450-600 Amperes Avg
500-1800 Volts

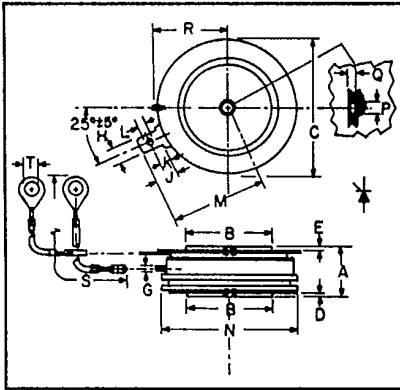

C431
Phase Control SCR
 450-600 Amperes/500-1800 Volts

C431
Outline Drawing

Dimensions	Inches		Millimeters	
	Min.	Max.	Min.	Max.
A	.560	.605	14.22	15.37
B	.985	.995	25.01	25.27
C	1.600	1.650	40.64	41.91
D	.030	—	.76	—
E	.040	—	1.01	—
G	.057	.059	1.44	1.50
H	.186	.191	4.72	4.85
J	.245	.255	6.22	6.48
K	.115	.130	2.92	3.30
L	.064	.070	1.62	1.78
M	—	1.120	—	28.45
N	—	1.585	—	40.26
P	.135	.145	3.42	3.68
Q	.070	.084	1.77	2.13
R	—	.875	—	22.23
S	12.219	12.343	310.36	313.51
T	.137	.153	3.47	3.89

Description

Powerex Silicon Controlled Rectifiers (SCR) are designed for phase control applications. These are all-diffused, Press-Pak (Pow-R-Disc) devices employing the field-proven amplifying (di/namic) gate.

Features:

- Low On-State Voltage
- High di/dt
- High dv/dt
- Hermetic Packaging
- Excellent Surge and I²t Ratings

Applications:

- Power Supplies
- Battery Chargers
- Motor Control
- Light Dimmers
- VAR Generators

Ordering Information

Example: Select the complete six or seven digit part number you desire from the table – i.e. C431T1 is a 900 Volt, 600 Ampere Phase Control SCR.

Type	Voltage		Current	
	V _{DRM} V _{RRM}	Code	I _T (avg)	Code
C431	500	E	450	2
	600	M		
	700	S	600	1
	800	N		
	900	T		
	1000	P		
	1100	PA		
	1200	PB		
	1300	PC		
	1400	PD		
	1500	PE		
	1600	PM		



T-25-20

Powerex, Inc., Hillis Street, Youngwood, Pennsylvania 15697 (412) 925-7272

Powerex Europe, S.A., 428 Ave. G. Durand, BP107, 72003 LeMans, France (43) 72.75.15

C431

Phase Control SCR

450-600 Amperes Avg/500-1800 Volts

Absolute Maximum Ratings

	Symbol	C431...1	C431...2	Units
RMS On-State Current	$I_{T(RMS)}$	950	700	Amperes
Average On-State Current	$I_{T(av)}$	600	450	Amperes
Peak One-Cycle Surge (Non Repetitive) On-State Current (60Hz)	I_{TSM}	8000	6500	Amperes
Peak One-Cycle Surge (Non-Repetitive) On-State Current (50Hz)	I_{TSM}	7300	5950	Amperes
Critical Rate-of-Rise of On-State Current (Non-Repetitive)	di/dt	150	150	Amperes/ μ s
Critical Rate-of-Rise of On-State Current (Repetitive)	di/dt	100	100	Amperes/ μ s
I^2t (for Fusing), One Cycle at 60Hz	I^2t	2.678×10^5	1.76×10^5	A ² sec
Peak Gate Power Dissipation	P_{GM}	200	200	Watts
Average Gate Power Dissipation	$P_{G(av)}$	5	5	Watts
Storage Temperature	T_{STG}	-40 to 150	-40 to 150	°C
Operating Temperature	T_J	-40 to 125	-40 to 125	°C
Mounting Force [ⓐ]		800-2500	800-2500	lb.
Mounting Force [ⓐ]		3.6-11.1	3.6-11.1	kN

[ⓐ] Consult recommended mounting procedures.



T-25-20

Powerex, Inc., Hillis Street, Youngwood, Pennsylvania 15697 (412) 925-7272
 Powerex Europe, S.A., 428 Ave. G. Durand, BP107, 72003 LeMans, France (43) 72.75.15

C431
 Phase Control SCR
 450-600 Amperes Avg/500-1800 Volts

Electrical and Thermal Characteristics

	Symbol	Test Conditions	C431_1	C431_2	Units
Current—Conducting State Maximums					
Peak On-State Voltage	V_{TM}	$I_{TM} = 3000A$ Peak, $T_J = 25^\circ C$, Duty Cycle $\leq 0.01\%$	2.62	3.6	Volts
Voltage—Blocking State Maximums					
Forward Leakage, Peak	I_{DRM}	$T_J = 125^\circ C$, $V = V_{DRM}$	45	60	mA
Reverse Leakage, Peak	I_{RRM}	$T_J = 125^\circ C$, $V = V_{RRM}$	45	60	mA
Switching					
Typical Turn-Off Time	t_q	$T_J = 125^\circ C$, $I_{TM} = 500A$; $V_R = 50V$ Min; V_{DRM} (Reapplied); $dv/dt = 20V/\mu sec$ (linear); Commutation $di/dt = 25A/\mu sec$; Repetition Rate = 1pps; Gate Bias during Turn-Off Interval = 0V, 100 Ω	200	75	μsec
Typical Delay Time	t_d	$T_J = 25^\circ C$, $I_T = 50A$, Gate Supply: 20V, 20 Ω , 0.1 μsec rise time	C431		μsec
Min. Critical dv/dt exponential to V_{DRM}	dv/dt	$T_J = 125^\circ C$, $V_{DRM} = .8$ Rated, Gate Open	200		V/ μsec
Thermal and Mechanical					
Maximum Thermal Resistance, [ⓐ] double sided cooling					
Junction to Case (2000 lb force)	$R_{\theta JC}$.045		$^\circ C/Watt$
Case to Sink, Lubricated (2000 lb force)	$R_{\theta CS}$.02		$^\circ C/Watt$
Gate—Maximum Parameters					
Gate Current to Trigger	I_{GT}	$V_D = 6Vdc$, $T_J = 25^\circ C$, $R_L = 3\Omega$	150		mA
Gate Voltage to Trigger	V_{GT}	$T_J = -40$ to $125^\circ C$, $V_D = 6Vdc$, $R_L = 3\Omega$	5		Volts
Non-Triggering Gate Voltage	V_{GDM}	$T_J = 125^\circ C$, Rated V_{DRM} , $R_L = 1000\Omega$.15		Volts
Peak Forward Gate Current	I_{GTM}		10		Amperes
Peak Reverse Gate Voltage	V_{GRM}		5		Volts

[ⓐ] Consult recommended mounting procedures.



T-25-70

Powerex, Inc., Hillis Street, Youngwood, Pennsylvania 15697 (412) 925-7272

Powerex Europe, S.A., 428 Ave. G. Durand, BP107, 72003 LeMans, France (43) 72.75.15

C431

Phase Control SCR

450-600 Amperes Avg/500-1800 Volts

MAXIMUM ON-STATE CHARACTERISTICS

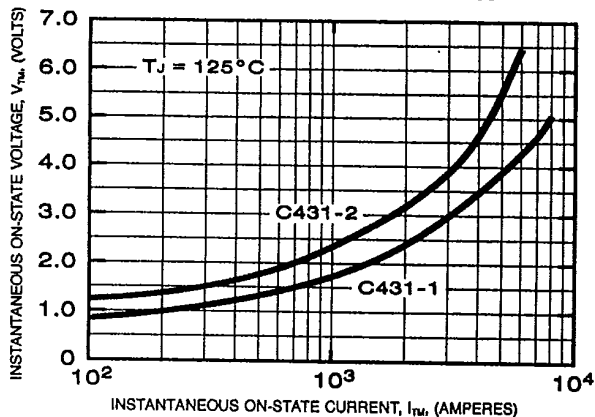

TRANSIENT THERMAL IMPEDANCE CHARACTERISTICS (JUNCTION TO CASE)

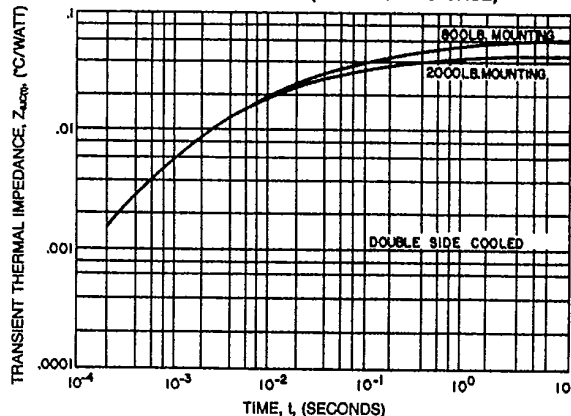

MAXIMUM ALLOWABLE CASE TEMPERATURE (SINUSOIDAL WAVEFORM)

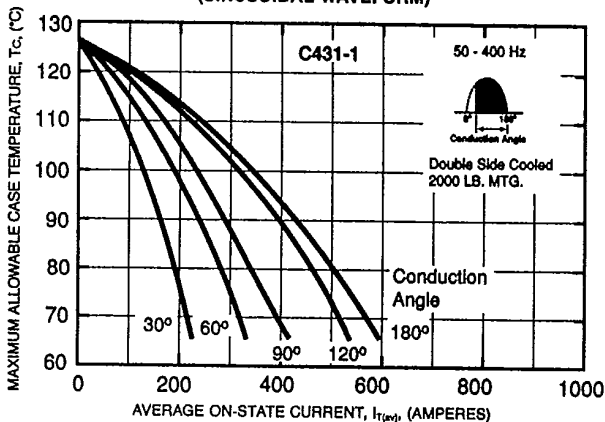

MAXIMUM ON-STATE POWER DISSIPATION (SINUSOIDAL WAVEFORM)

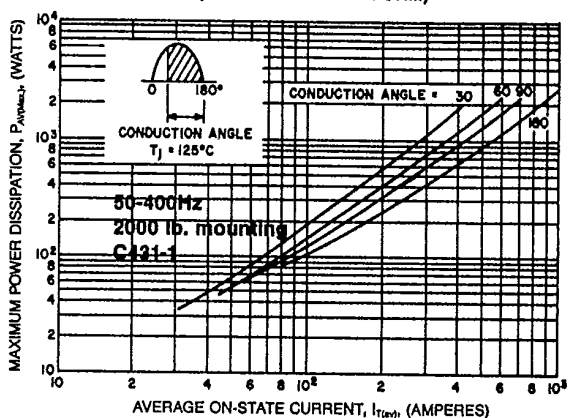

MAXIMUM ALLOWABLE CASE TEMPERATURE (RECTANGULAR WAVEFORM)

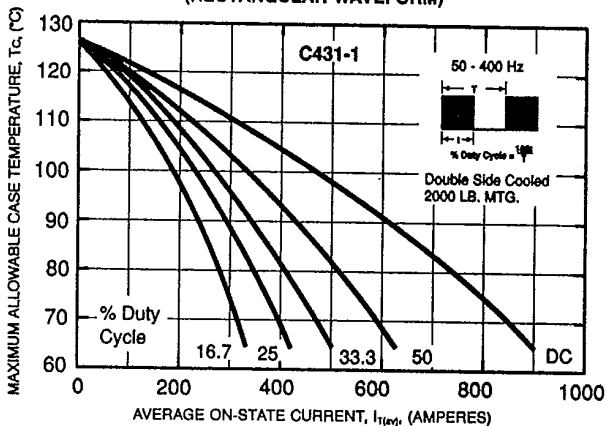

MAXIMUM ON-STATE POWER DISSIPATION (RECTANGULAR WAVEFORM)

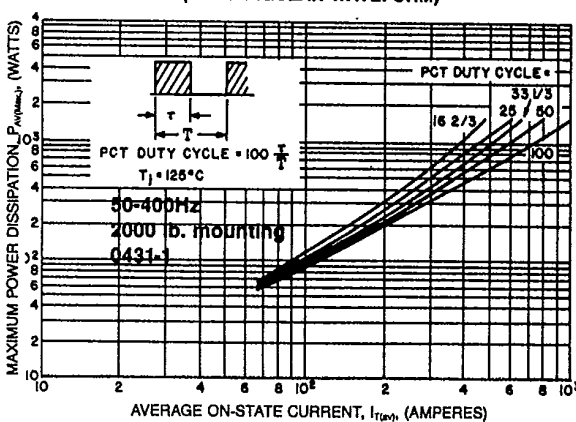



T-25-20

Powerex, Inc., Hillis Street, Youngwood, Pennsylvania 15697 (412) 925-7272
 Powerex Europe, S.A., 428 Ave. G. Durand, BP107, 72003 LeMans, France (43) 72.75.15

C431
Phase Control SCR
 450-600 Amperes Avg/500-1800 Volts

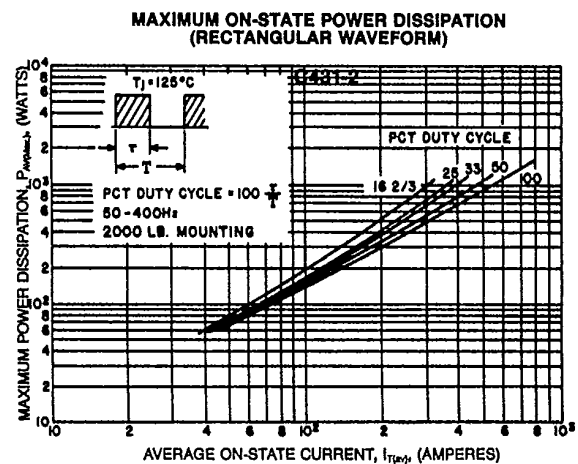
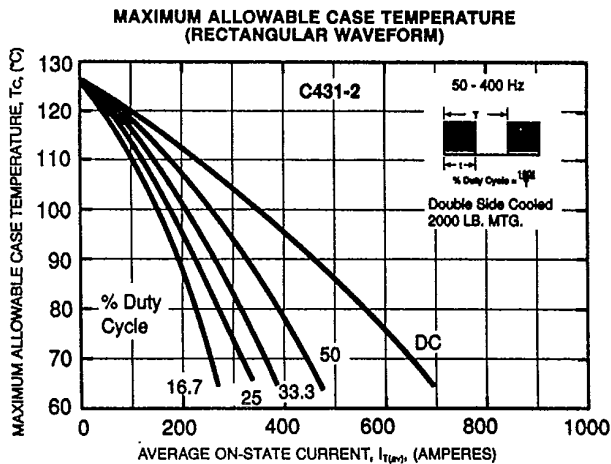
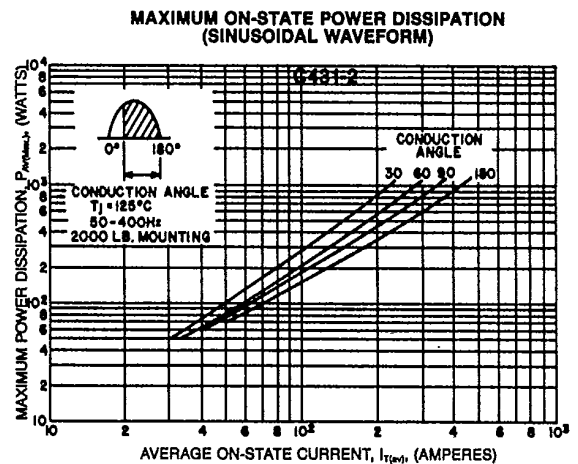
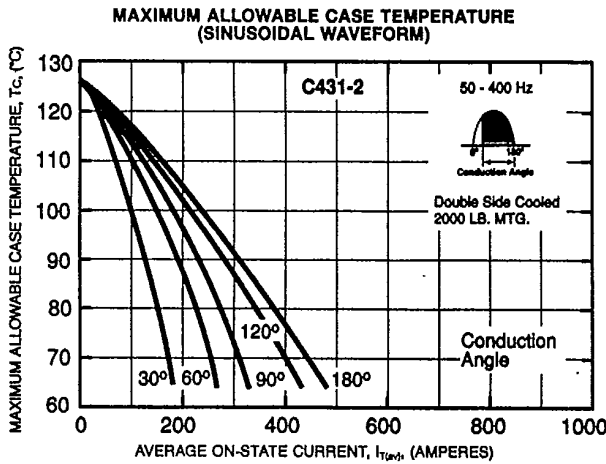
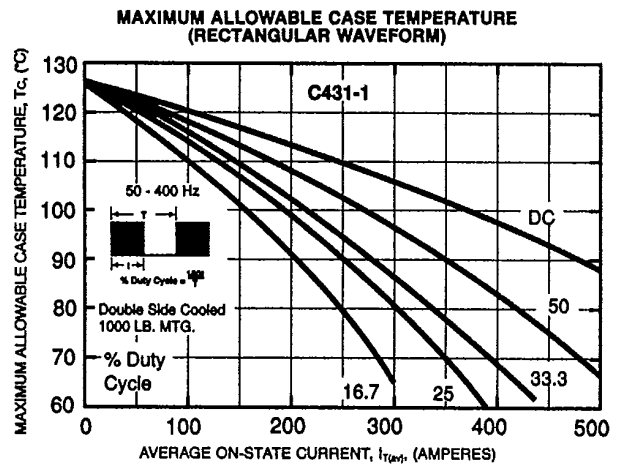
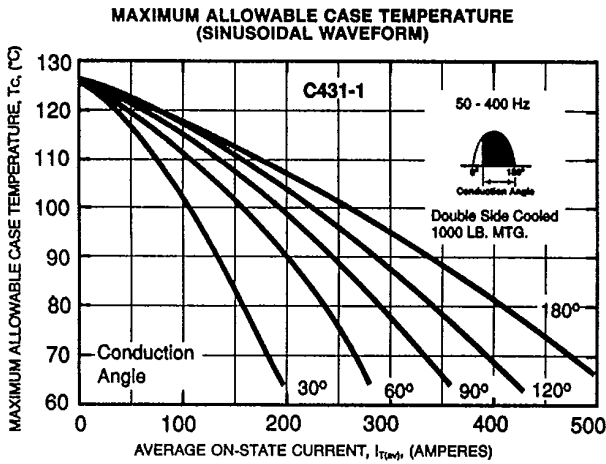



T-25-20

Powerex, Inc., Hillis Street, Youngwood, Pennsylvania 15697 (412) 925-7272
 Powerex Europe, S.A., 428 Ave. G. Durand, BP107, 72003 LeMans, France (43) 72.75.15

C431
 Phase Control SCR
 450-600 Amperes Avg/500-1800 Volts

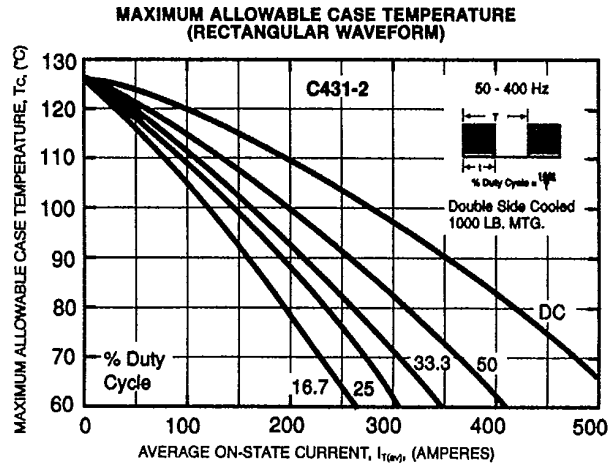
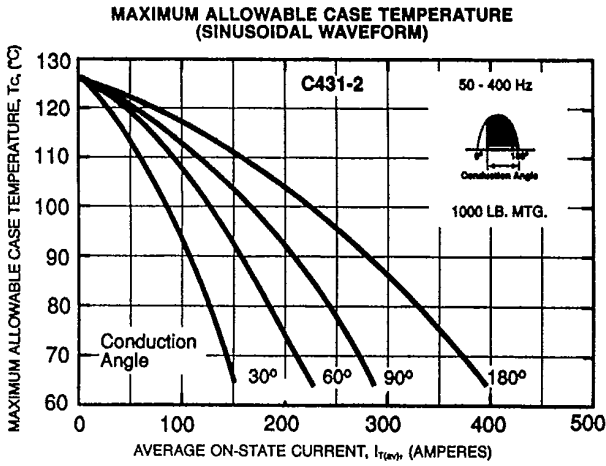

SUB-CYCLE SURGE AND I²t RATINGS (RATED LOAD CONDITIONS)

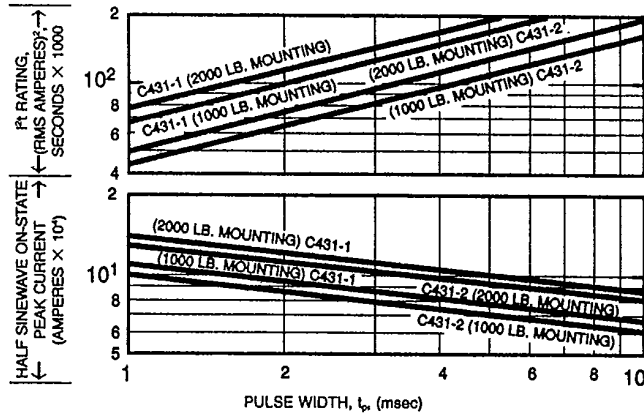

MAXIMUM RECOVERED CHARGE

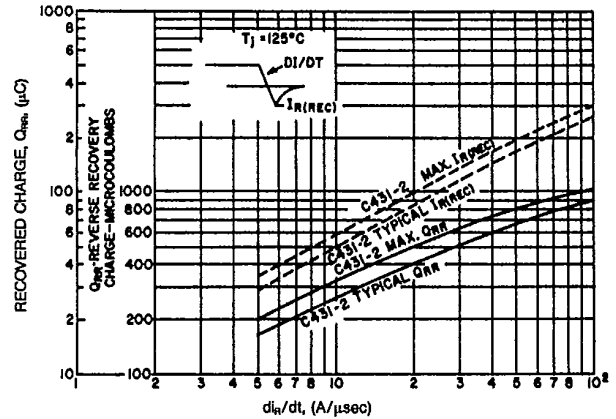

GATE CHARACTERISTICS

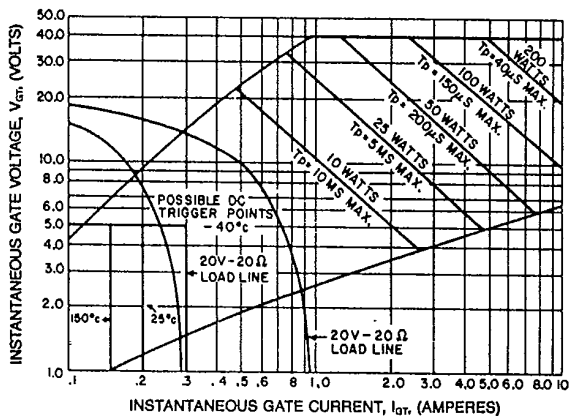

NOTES:

1. Maximum allowable average gate dissipation = 5 watts.
2. The locus of possible dc trigger points lie outside the boundaries shown at various case temperatures.
3. T_p = Rectangular gate current pulse width (5μs min. duration; 1.0μs max. rise time for 20V, 65Ω source).
4. 20V - 20Ω is the minimum gate source load line when rate of circuit current rise > 100 Amp/μs or anode rate of current rise > 200 Amps/μs (T_p = 5μs min., 0.5μs max. rise time).

Maximum long-term repetitive anode di/dt = 500 Amps/μs with 20V - 20Ω gate source.