

E-Series Surface Mount Mixer
80 – 2500 MHz

ESMD-C50M
V3

Features

- LO Power +13 dBm
- Up to +8 dBm RF
- Surface Mount
- Tape and reel packaging available

Description

M/A-COM's ESMD-C50M is a Low Cost, Medium Drive, Passive, Double Double Balanced Mixer. Constructed using very broad band ferrite balun transformers and matched silicon schottky diodes. It's performance is especially suited to high dynamic range receivers. Given it's high 1dB compression point, the ESMD-C50M is also suitable for Transmitter upconversion at any frequency up to 2.5GHz. Parts are packaged in tape & reel.

SM - 2 Package

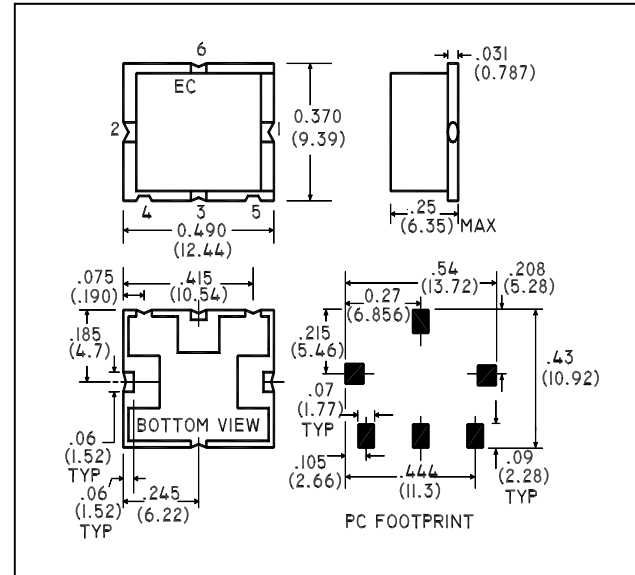

Electrical Specifications: $T_A = 25^\circ\text{C}$, $Z_0 = 50\Omega$ ¹

Parameter	Test Conditions	Frequency	Units	Min	Typ	Max
Frequency	IF 1.0 dB bandwidth = DC - 1000 MHz	80 -2500	MHz	—	—	—
Conversion Loss	—	80 - 1000 1000 - 2500	dB	—	6.21 7.37	7.5 9.0
Isolation	LO to RF	80 - 1000 1000 - 2500	dB	27 22	32.5 29.1	— —
Isolation	LO to IF	80 - 1000 1000 - 2500	dB	25 15	31.8 19.8	— —
Isolation	RF to IF	80 - 1000 1000 - 2500	dB	22 18	28.3 24.6	— —
VSWR	LO	80 - 1000 1000 - 2500	—	—	1.56 1.25	2.15 1.7
VSWR	RF	80 - 1000 1000 - 2500	—	—	1.62 1.71	2.1 2.2
VSWR	IF	DC - 600	—	—	1.65	2.3
Input IP3	—	200 - 1000 1000 - 2500	dBm	21.0 17.0	26.6 23.5	— —
Input 1 dB Compression	—	80 -2500	dBm	—	8.0	—

Ordering Information

Part Number	Package
ESMD-C50MTR	Tape and Reel (500 piece Reel)

1

M/A-COM Inc. and its affiliates reserve the right to make changes to the product(s) or information contained herein without notice. M/A-COM makes no warranty, representation or guarantee regarding the suitability of its products for any particular purpose, nor does M/A-COM assume any liability whatsoever arising out of the use or application of any product(s) or information.

• **North America** Tel: 800.366.2266 / Fax: 978.366.2266
 • **Europe** Tel: 44.1908.574.200 / Fax: 44.1908.574.300
 • **Asia/Pacific** Tel: 81.44.844.8296 / Fax: 81.44.844.8298

Visit www.macom.com for additional data sheets and product information.

Pin Configuration

Pin No.	Function
1	RF
2	LO
3	IF
4	Ground
5	Ground
6	Ground

Schematic

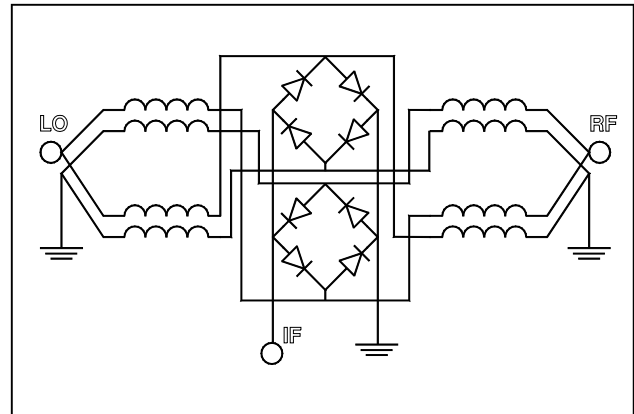

Absolute Maximum Ratings ¹

Parameter	Absolute Maximum
RF Input Power	+20 dBm
LO Drive Power	+20 dBm
Operating Temperature	-40°C to +85°C
Storage Temperature	-55°C to +125°C

1. Operation of this device above any one of these parameters may cause permanent damage.

Typical Performance Curves

Conversion Loss

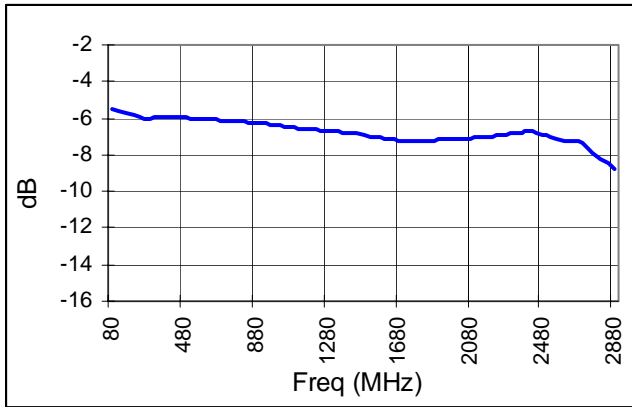

Isolation

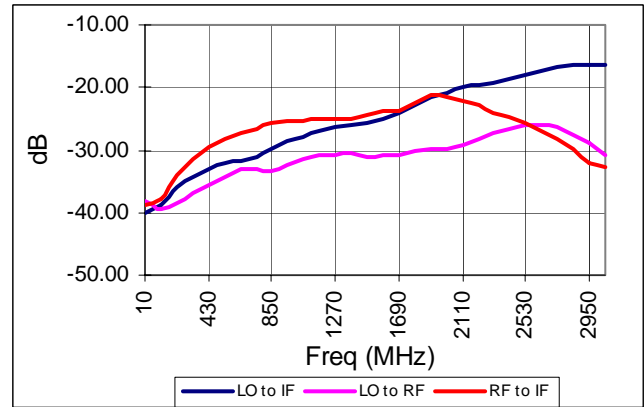

LO & RF VSWR

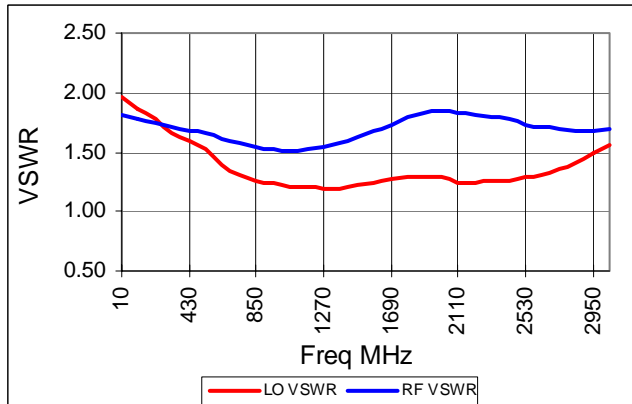

IF VSWR

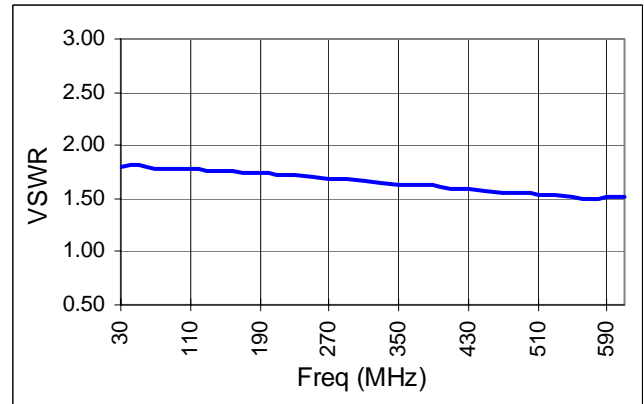

IF Bandwidth

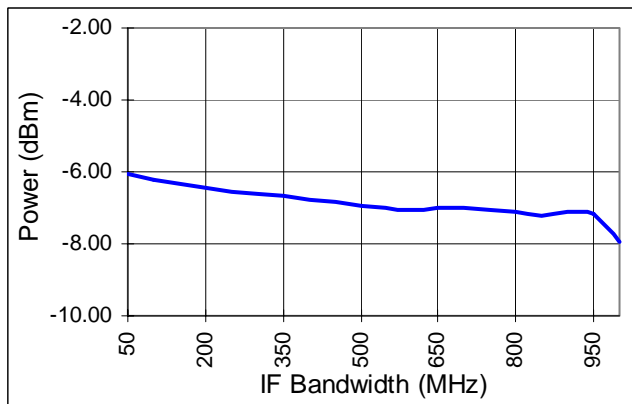

IIP3 & 1 dB Compression

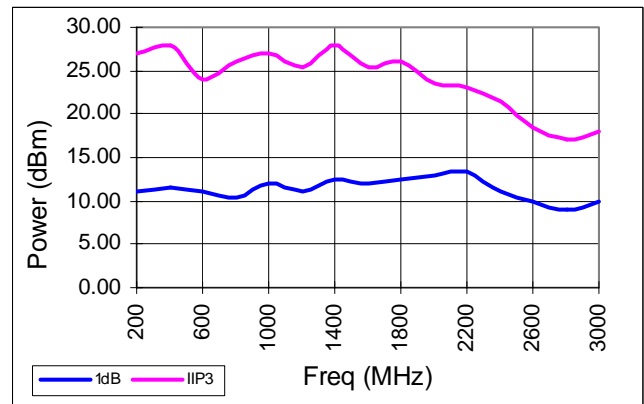

Spurious Table: 1800MHz

(In dBc below IF, assuming down conversion)

		nf _{LO} - mf _{RF}					
		0	X	-3	19	32	28
		1	19	0	31	17	43
RF		2	54	52	52	48	56
(n)		3	72	65	78	63	68
		4	83	83	84	82	84
		0	1	2	3	4	

LO (m)

RF = 1842.50 MHz, -5dBm
LO = 1772.50 MHz, +13dBm
IF = 70 MHz

Spurious Table: 900MHz

(In dBc below IF, assuming down conversion)

		nf _{LO} - mf _{RF}					
		0	X	8	23	15	30
		1	18	0	36	12	35
RF		2	58	49	55	52	53
(n)		3	67	68	67	68	67
		4	85	84	82	83	83
		0	1	2	3	4	

LO (m)

RF = 970 MHz, -5dBm
LO = 900 MHz, +13dBm
IF = 70 MHz

Spurious Table: 1900MHz

(In dBc below IF, assuming down conversion)

		nf _{LO} - mf _{RF}					
		0	X	-5	22	13	29
		1	16	0	38	17	18
RF		2	26	22	23	26	41
(n)		3	48	38	50	42	38
		4	50	55	54	52	55
		0	1	2	3	4	

LO (m)

RF = 1960 MHz, -5dBm
LO = 1890 MHz, +13dBm
IF = 70 MHz