

GL7101

EARTH LEAKAGE CURRENT DETECTOR

Description

The GL7101 is designed for use in earth leakage circuit interrupters for operation directly off the AC Line in breakers.

It contains pre regulator, main regulator, after regulator, differential amplifier, level comparator, latch circuit. The input in the differential amplifier is connect to the secondary node of zero current transformer.

The level comparator generates high level when earth leakage current is greater than some level.

(Top view)

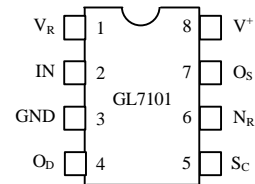

Feature

- Low Power consumption ($P_D = 5mW$) 100V/ 200V
- 100V/200V Common Built-in Voltage Regulator
- High Gain Differential Amplifier
- High Input Sensitivity
- Minimum External Parts
- Large Surge Margin
- Wide Operating Temperature Range ($T_A = -30$ to 85 °C)
- High Noise Immunity

Absolute Maximum Rating ($T_A = 25$ °C)

Supply voltage	20	V
Supply Current	8	mA
Power Dissipation	200	mW
Operating Temperature	-30 to 85	°C
Storage Temperature	-55 to 125	°C

Pin Configuration

Block diagram

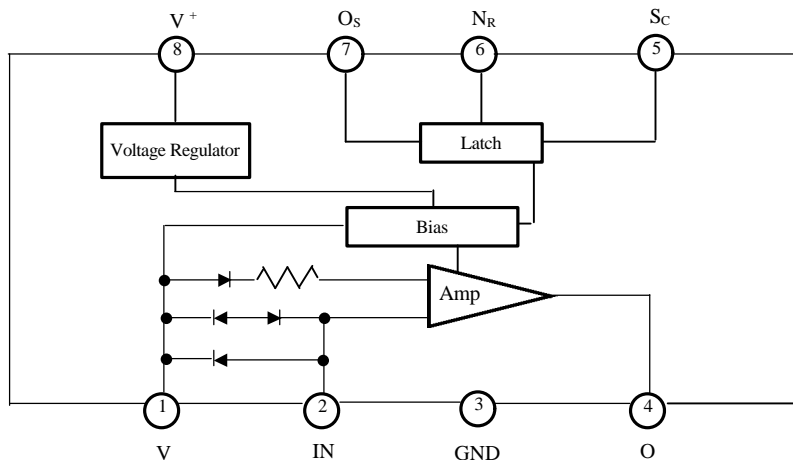

Recommended Operating Condition : $T_a = -30$; \dot{E} to 80 ; \dot{E}

PARAMETER	SYMBOL	MIN.	TYP.	MAX.	UNIT
Supply Voltage	V^+	12			V
V_S -GND Capacitor	C_{VS}	1			μF
O_S -GND Capacitor	C_{OS}			1	μF

Electrical Characteristics

PARAMETER	SYMBOL	CONDITIONS	TEMP (\dot{E})	MIN.	TYP.	MAX.	UNIT	TEST CIRCUIT
Supply Current 1	I_{S1}	$V^+=12V, V_R-V_I=30mV$	-30	-	-	580	μA	1
			25	-	400	530		
			85	-	-	480		
* Trip Voltage	V_T	$V^+=16V, V_R-V_I=X$	-30 85	9	13.5	18	mV(rms)	2
Differential Amplifier Output Current 1	I_{TD1}	$V^+=16V, V_R-V_I=30mV$ $V_{OD}=1.2V$	25	-12	-	-30	μA	3
Differential Amplifier Output Current 2	I_{TD2}	$V^+=6V, V_R-V_I=short$ $V_{OD}=0.8V$	25	17	-	37	μA	4
Output Current	I_O	$V_{SC}=1.4V$ $V_{OS}=0.8V$	$I_{SI}=580 \mu A$	-30	-200	-	μA	5
			$I_{SI}=530 \mu A$	25	-100	-		
			$I_{SI}=480 \mu A$	85	-75	-		
S_C On Voltage	$V_{SC ON}$	$V^+=16V$	25	0.7	-	1.4	V	6
S_C Input Current	$I_{SC ON}$	$V^+=12V$	25	-	-	5	μA	7
Output "L" Current	I_{OSL}	$V^+=12V, V_{OSL}=0.2V$	-30 85	200	-	-	μA	8
Input Clamp Voltage	V_{IC}	$V^+=12V, V_{IC}=20mA$	-30 85	4.3	-	6.7	V	9
Differential Input Clamp Voltage	V_{IDC}	$I_{IDC}=100mV$	-30 85	0.4	-	2	V	10
Max. Current voltage	V_{SM}	$I_{SM}=7mA$	25	20	-	28	V	11
Supply Current 2	I_{S2}	$V_{OS}=0.5V, V_R-V_I=X$	-30 85	-	-	900	μA	12
Latch Circuit Off Supply Voltage	V_{+OFF}		25	0.5	-		V	13
Response Time	T_{ON}	$V^+=16V, V_R-V_I=0.3V$	25	1	-	4	ms	14

* A: 9 ~ 12.55 B: 11.5 ~ 15.5 C: 14.5 ~ 18

Typical Performance Curves

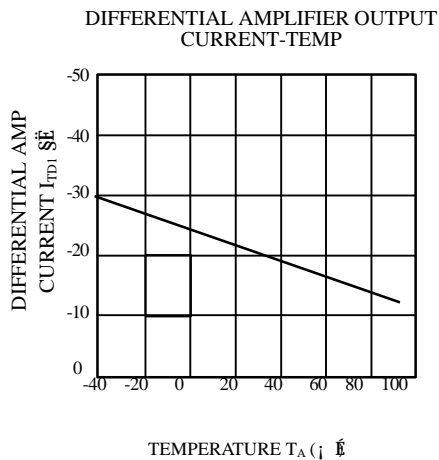
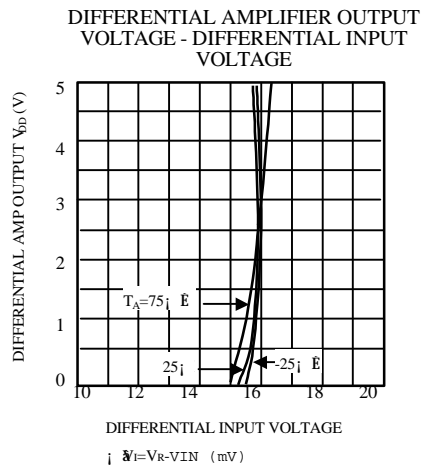
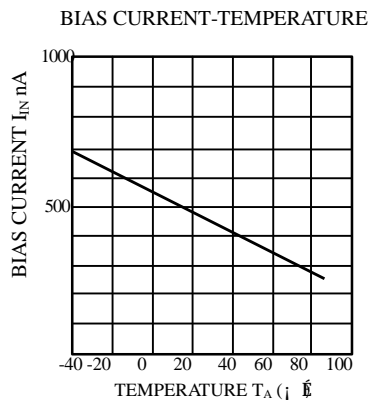
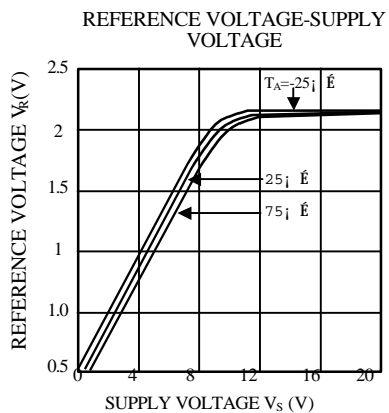
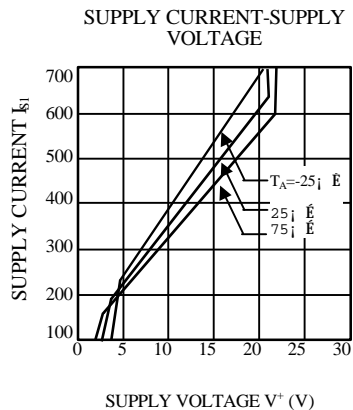
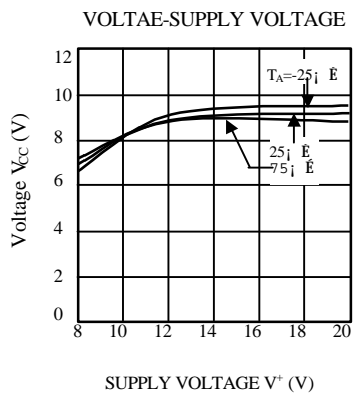

Test Circuit

1.

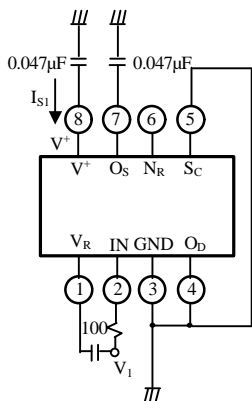

2.

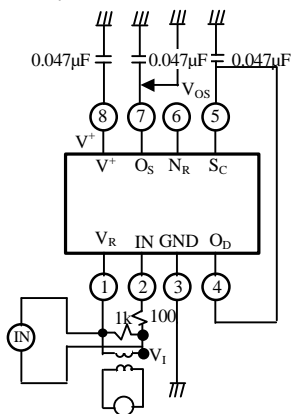

3.

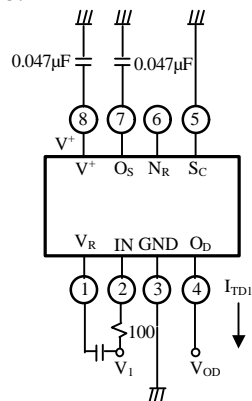

4.

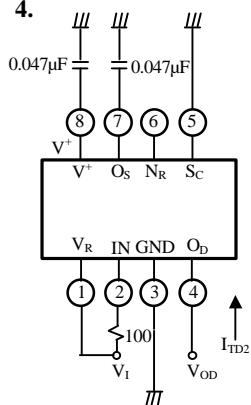

5.

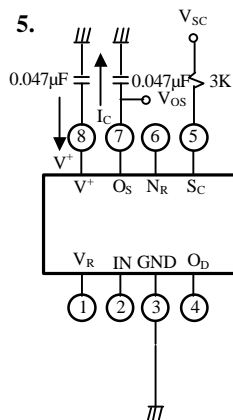

6.

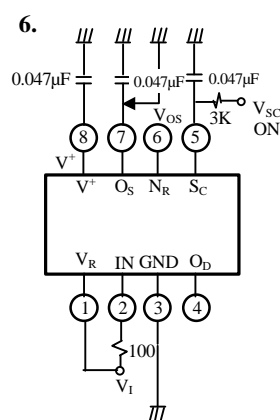

7.

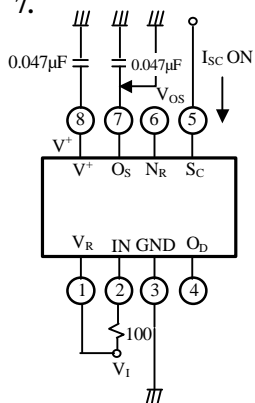

8.

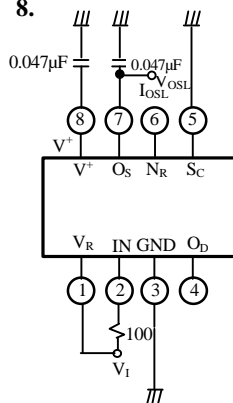

9.

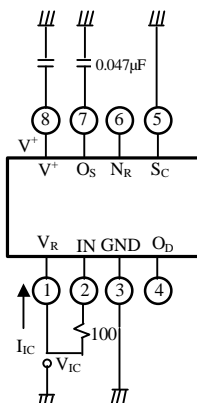

10.

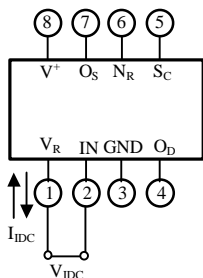

11.

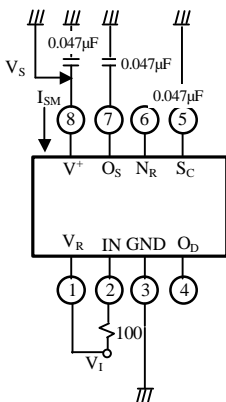

12.

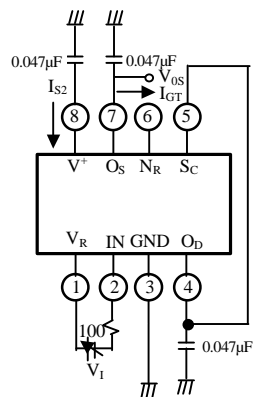

13.

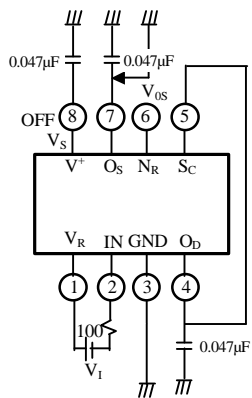

14.

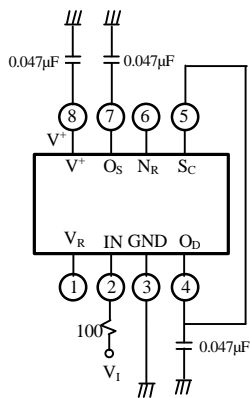

Typical Application

