



# *TANTALUM HIGH RELIABILITY*



To find parts fast, visit



at [www.kemet.com](http://www.kemet.com).



# GR500 INDEX

Introduction .....3

**GR500/T210**

    ordering information .....4

    ratings and part number reference .....4-6

    capacitor markings .....6

    applications information .....7-10

**GR500/T240**

    ordering information .....11

    ratings and part number reference .....12

    capacitor markings .....12

    applications information .....13-15

**GR500 GRADED RELIABILITY SPECIFICATION**

    scope .....16

    applicable documents .....16

    requirements .....16-18

    quality assurance provisions .....18-21

    preparation for delivery .....22

    certified grading papers .....23

**Notice**

Although the information in this catalog has been carefully checked for accuracy, and is believed to be correct and current, no warranty, either express or implied, is made to either its applicability to, or its compatibility with, specific requirements; nor does KEMET Electronics Corporation assume any responsibility for correctness of this information, nor for damages consequent to its use. All design characteristics, specifications, tolerances, and the like are subject to change without notice.

## Introduction

The solid tantalum capacitor has become an essential device in circuits requiring high capacitance-voltage product and extended environmental capability. The KEMET GR500 Graded Reliability concept has made available state-of-the-art devices providing maximum assurance of meeting system reliability goals. All Graded Reliability capacitors receive meticulous attention from raw material selection through manufacture, final inspection and shipping. Having survived a very stringent quality control program, the resulting capacitors meet or exceed the most critical requirements of space, satellite, missile and medical applications where failure is, at best, expensive, and at worst, fatal.

KEMET is, therefore, committed to the principle of the highest possible reliability in the manufacture and grading of its GR500 Series capacitors.

The KEMET GR500 High Reliability concept disallows grouping of diverse ratings and production batches to determine average failure rates. Instead, data from each and every capacitor batch are statistically fitted to determine failure rate on the basis of 100% life testing. Each homogeneous production batch is "graded" as a single inspection lot, and documented evidence of failure rate achieved is supplied with the parts, providing assurance of the most sophisticated and accurate reliability measurement method in the industry.

## Basic Requirements

**A. Manufacturing Environment** — It is of vital importance that high reliability electronic components be manufactured in an environment which provides commitment to the philosophy of high reliability production. GR500 Series capacitors are manufactured in a plant area that stresses this philosophy. Manufacturing and quality control personnel are selected for experience and competence. Extensive training in quality and reliability assurance techniques is provided, and motivation of personnel is heavily stressed. Raw material and in-process inspection techniques are especially rigid. The result is a capacitor product of inherently superior quality.

**B. Screening Test** — All GR500 Series capacitors are subjected to a broad test program. Despite the most rigid of quality control procedures, some variation among batches of capacitors must be recognized. This fact is understandable when one considers the inherent differences which derive from the 16 to 1 ratio of operating voltages, the 20 to 1 ratio of physical sizes, and the 60,000 to 1 ratio among capacitance ratings. Maximum assurance of reliability is achieved by maintaining batch identity from the raw material with respect to capacitor sizes and ratings as well as material identification. Each batch is then subjected to extensive, non-destructive 100% screening tests as indicated below.

**1. Thermal Shock** — Inherent variations exist among the temperature coefficients of expansion of the various materials required in the manufacture of solid tantalum capacitors. In worst-case combinations, individual capacitors will exhibit sensitivity to temperature excursions. Consequently, all GR500 Series capacitors undergo ten temperature cycles between -65°C and

+125°C prior to the electrical testing which eliminates those capacitors failing to withstand this extreme change in environment.

**2. Surge Current** — Each GR500 capacitor receives 10 cycles @ -55°C, +85°C. Each cycle consists of rated voltage charge for 4±1 seconds and a discharge for 4±1 seconds. Total DC resistance (excluding the test capacitor) is ≤1.0 ohms. The energy storage bank capacitor(s) is 100,000 µF minimum.

**3. Grading** — This term is used to describe the technique which defines the failure rate of KEMET Graded Reliability capacitors. Grading consists of placing GR500 capacitors in an oven at 85°C for a minimum of 250 hours at a voltage greater than rated voltage. The technique is fundamentally based upon the oft-documented fact that solid tantalum capacitors do not conform to the exponential distribution of time-ordered failures, but instead exhibit a constantly decreasing failure rate. The Weibull distribution provides a valuable tool for describing the behavior of solid tantalum capacitors, and experimental fits are made to this distribution in determining performance levels for each GR500 Series batch. Actual test data are provided with each shipment of capacitors to document the failure rate obtained.

**4. Electrical Testing** — Each GR500 Series capacitor is tested at 25°C for leakage current at rated voltage, as well as capacitance and dissipation factor at 120 Hz. Since uniformity is generally a valid indicator of reliability, parametric distributions are graphically recorded for each lot. Parts which deviate from the normal population are discarded. Guaranteed maximum values are as detailed in Table 1.

**5. ESR** — Each GR500 capacitor is tested for ESR @ 100 KHz. See electrical specification tables.

**6. X-ray** — Each GR500 Series capacitor is examined by X-ray in two planes with 90 degree rotation. Since assembly of the solid tantalum capacitor is a blind operation, optical inspection cannot reveal internal defects such as loose solder balls or deficient anode solder bonding.

**7. Hermeticity** — Each GR500 capacitor receives hermeticity testing per MIL-STD-202, Method 112, Condition D. This test uses a fluorocarbon liquid at 125°C±5° (257°F±9°F) at ambient pressure and detects gross leaks by the observation of bubbles.

**C. Sampling** — In addition to the 100% screening tests, other tests are imposed on a sample basis to determine parametric stability and resistance to environmental extremes. These tests are fully described in the GR500 Graded Reliability Specification.

**D. Available Special Testing** — In addition to the standard testing outlined in this catalog, optional testing is available.

1. 100% ESR testing at various frequencies
2. 1 KHz DF
3. Tightened DC leakage, Capacitance and Dissipation Factor limits.

**DETAIL SPECIFICATION**  
**GR500/T210 Capacitors**  
**CAPACITOR OUTLINE DRAWINGS**

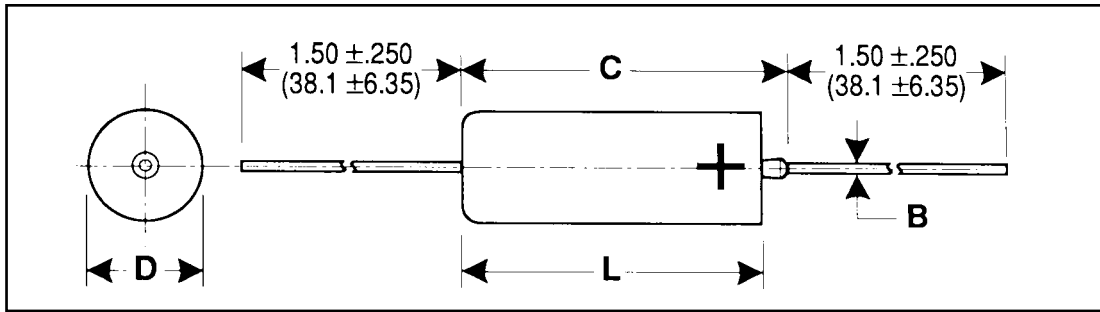

CASE SIZE	UNINSULATED		INSULATED		B ±0.001 ±(.03)	C MAX.
	D ±0.005 ±(.13)	L ±0.031 ±(.79)	D ±0.010 ±(.25)	L ±0.031 ±(.79)		
A	0.125 (3.18)	0.250 (6.35)	0.135 (3.43)	0.286 (7.26)	0.020 (.51)	0.422 (10.72)
B	0.175 (4.45)	0.438 (11.13)	0.185 (4.70)	0.474 (12.04)	0.020 (.51)	0.610 (15.49)
C	0.279 (7.09)	0.650 (16.51)	0.289 (7.34)	0.686 (17.42)	0.025 (.64)	0.822 (20.88)
D	0.341 (8.66)	0.750 (19.05)	0.351 (8.92)	0.786 (19.96)	0.025 (.64)	0.922 (23.42)

**T210 ORDERING INFORMATION**

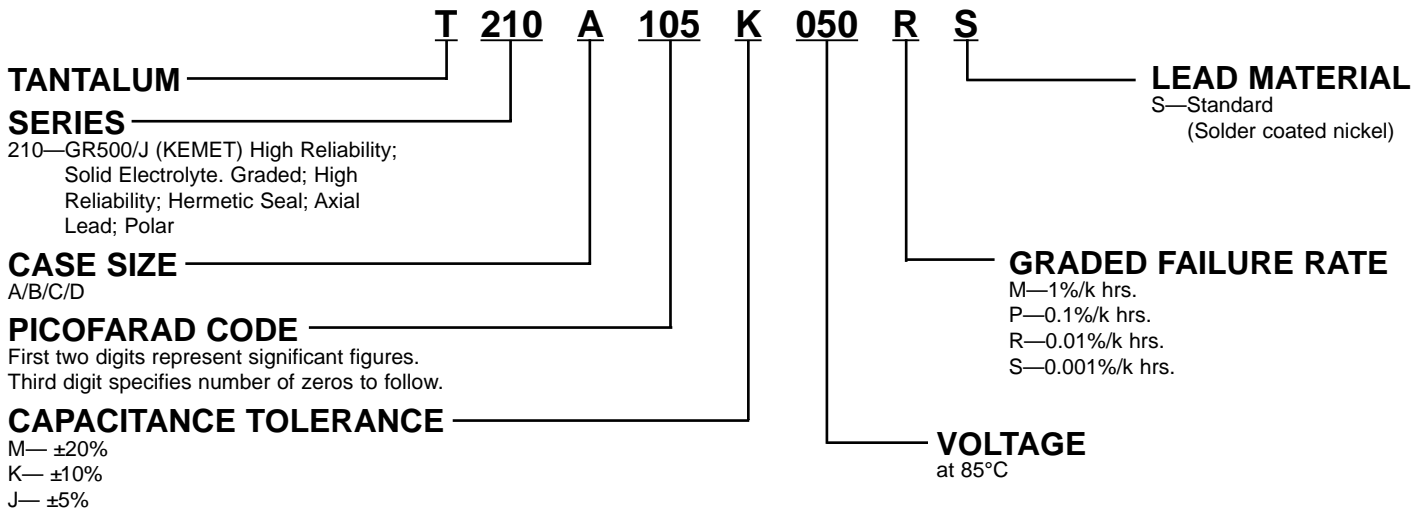

**RATINGS & PART NUMBER REFERENCE**

NOMINAL CAPACITANCE (μF) 25°C 120 Hz	CASE SIZE	PART NUMBER	GRADED FAILURE RATES	MAXIMUM LEAKAGE CURRENT AT RATED VOLTS			MAXIMUM DISSIPATION FACTOR (%) AT 120 Hz		ESR MAXIMUM OHMS 100 kHz +25°C	NOMINAL CAPACITANCE (μF) 25°C 120 Hz	CASE SIZE	PART NUMBER	GRADED FAILURE RATES	MAXIMUM LEAKAGE CURRENT AT RATED VOLTS			MAXIMUM DISSIPATION FACTOR (%) AT 120 Hz		ESR MAXIMUM OHMS 100 kHz +25°C
				+25°C (μA)	+85°C (μA)	+125°C (μA)	-55°C +25°C	+85°C +125°C						+25°C (μA)	+85°C (μA)	+125°C (μA)	-55°C +25°C	+85°C +125°C	
<b>6 VOLT RATING AT 85°C—4 VOLT RATING AT 125°C</b>										<b>6 VOLT RATING AT 85°C—4 VOLT RATING AT 125°C</b>									
3.9	A	T210A395(1)006(2)S	R,S	0.1	1.0	1.25	4.0	4.0	1.00	27.0	B	T210B276(1)006(2)S	R,S	0.5	5.0	6.25	4.0	6.0	0.25
4.7	A	T210A475(1)006(2)S	R,S	0.1	1.0	1.25	4.0	4.0	0.90	33.0	B	T210B336(1)006(2)S	R,S	0.5	5.0	6.25	4.0	6.0	0.24
5.6	A	T210A565(1)006(2)S	R,S	0.1	1.0	1.25	4.0	4.0	0.90	39.0	B	T210B396(1)006(2)S	R,S	0.5	5.0	6.25	4.0	6.0	0.24
6.8	A	T210A685(1)006(2)S	R,S	0.1	1.0	1.25	4.0	6.0	0.80	47.0	B	T210B476(1)006(2)S	R,S	0.5	5.0	6.25	4.0	6.0	0.24
										56.0	B	T210B566(1)006(2)S	R,S	0.5	5.0	6.25	4.0	6.0	0.24

(1) To complete Part Number, insert Capacitance Tolerance Symbol in 9th character, M— ±20%, K— ±10%, J— ±5%.  
 (2) To complete Part Number, insert Failure Rate Symbol in the 13th character as shown above.

# DETAIL SPECIFICATION

## GR500/T210 Capacitors

### CAPACITOR OUTLINE DRAWINGS

NOMINAL CAPACITANCE (μF) 25°C 120 Hz	CASE SIZE	PART NUMBER	GRADED FAILURE RATES	MAXIMUM LEAKAGE CURRENT AT RATED VOLTS			MAXIMUM DISSIPATION FACTOR (%) AT 120 Hz		ESR MAXIMUM OHMS 100 kHz 25°C	NOMINAL CAPACITANCE (μF) 25°C 120 Hz	CASE SIZE	PART NUMBER	GRADED FAILURE RATES	MAXIMUM LEAKAGE CURRENT AT RATED VOLTS			MAXIMUM DISSIPATION FACTOR (%) AT 120 Hz		ESR MAXIMUM OHMS 100 kHz 25°C
				+25°C (μA)	+85°C (μA)	+125°C (μA)	-55° +25°C	+85°C +125°C						+25°C (μA)	+85°C (μA)	+125°C (μA)	-55° +25°C	+85°C +125°C	
<b>6 VOLT RATING AT 85°C—4 VOLT RATING AT 125°C</b>										<b>20 VOLT RATING AT 85°C—13 VOLT RATING AT 125°C (CONT'D.)</b>									
82.0	C	T210C826μ006μS	R,S	1.5	15.0	18.75	5.0	8.0	0.12	4.7	B	T210B475μ020μS	R,S	0.5	5.0	6.25	4.0	6.0	0.51
100.0	C	T210C107μ006μS	R,S	1.5	15.0	18.75	5.0	8.0	0.11	5.6	B	T210B565μ020μS	P,R	0.5	5.0	6.25	4.0	6.0	0.47
120.0	C	T210C127μ006μS	R,S	1.5	15.0	18.75	5.0	8.0	0.10	6.8	B	T210B685μ020μS	P,R	0.5	5.0	6.25	4.0	6.0	0.43
150.0	C	T210C157μ006μS	R,S	1.5	15.0	18.75	5.0	8.0	0.09	8.2	B	T210B825μ020μS	P,R	0.5	5.0	6.25	4.0	6.0	0.39
180.0	C	T210C187μ006μS	R,S	1.5	15.0	18.75	5.0	8.0	0.08	10.0	B	T210B106μ020μS	P,R	0.5	5.0	6.25	4.0	6.0	0.35
220.0	D	T210D227μ006μS	R,S	2.0	20.0	25.00	6.0	8.0	0.07	12.0	B	T210B126μ020μS	P,R	0.5	5.0	6.25	4.0	6.0	0.32
270.0	D	T210D277μ006μS	R,S	2.0	20.0	25.00	6.0	8.0	0.07	15.0	B	T210B156μ020μS	P,R	0.5	5.0	6.25	4.0	6.0	0.29
330.0	D	T210D337μ006μS	R,S	3.0	30.0	39.50	6.0	8.0	0.06	18.0	C	T210C186μ020μS	R,S	1.0	10.0	12.50	4.0	6.0	0.25
<b>10 VOLT RATING AT 85°C—7 VOLT RATING AT 125°C</b>										<b>35 VOLT RATING AT 85°C—23 VOLT RATING AT 125°C</b>									
2.7	A	T210A275μ010μS	R,S	0.1	1.0	1.25	4.0	4.0	1.20	0.82	A	T210A824μ035μS	R,S	0.1	1.0	1.25	2.0	4.0	1.60
3.3	A	T210A335μ010μS	R,S	0.1	1.0	1.25	4.0	4.0	1.00	1.0	A	T210A105μ035μS	R,S	0.1	1.0	1.25	2.0	4.0	1.40
3.9	A	T210A395μ010μS	R,S	0.1	1.0	1.25	4.0	4.0	1.00	2.7	B	T210B275μ035μS	R,S	0.25	2.5	3.13	3.0	4.0	0.68
4.7	A	T210A475μ010μS	R,S	0.1	1.0	1.25	4.0	4.0	0.90	3.3	B	T210B335μ035μS	R,S	0.5	5.0	6.25	3.0	4.0	0.62
12.0	B	T210B126μ010μS	R,S	0.5	5.0	6.25	4.0	6.0	0.32	3.9	B	T210B395μ035μS	R,S	0.5	5.0	6.25	3.0	4.0	0.56
15.0	B	T210B156μ010μS	R,S	0.5	5.0	6.25	4.0	6.0	0.29	4.7	B	T210B475μ035μS	R,S	0.5	5.0	6.25	3.0	4.0	0.51
18.0	B	T210B186μ010μS	R,S	0.5	5.0	6.25	4.0	6.0	0.27	5.6	B	T210B565μ035μS	M,P	0.5	5.0	6.25	3.0	4.0	0.47
22.0	B	T210B226μ010μS	R,S	0.5	5.0	6.25	4.0	6.0	0.26	6.8	B	T210B685μ035μS	M,P	0.5	5.0	6.25	3.0	4.0	0.43
27.0	B	T210B276μ010μS	R,S	0.5	5.0	6.25	4.0	6.0	0.25	8.2	C	T210C825μ035μS	R,S	1.0	10.0	12.50	3.0	5.0	0.36
33.0	B	T210B336μ010μS	R,S	0.5	5.0	6.25	4.0	6.0	0.24	10.0	C	T210C106μ035μS	R,S	1.0	10.0	12.50	3.0	5.0	0.33
39.0	B	T210B396μ010μS	R,S	0.5	5.0	6.25	4.0	6.0	0.24	12.0	C	T210C126μ035μS	P,R	1.0	10.0	12.50	3.0	5.0	0.30
47.0	C	T210C476μ010μS	R,S	1.5	15.0	18.75	5.0	6.0	0.16	15.0	C	T210C156μ035μS	P,R	1.0	10.0	12.50	3.0	5.0	0.27
56.0	C	T210C566μ010μS	R,S	1.5	15.0	18.75	5.0	6.0	0.15	18.0	C	T210C186μ035μS	P,R	1.0	10.0	12.50	3.0	5.0	0.25
68.0	C	T210C686μ010μS	R,S	1.5	15.0	18.75	5.0	6.0	0.13	22.0	C	T210C226μ035μS	M,P	1.0	10.0	12.50	3.0	5.0	0.25
82.0	C	T210C826μ010μS	R,S	1.5	15.0	18.75	5.0	6.0	0.12	27.0	D	T210D276μ035μS	M,P	2.0	20.0	25.00	3.0	5.0	0.18
100.0	C	T210C107μ010μS	R,S	1.5	15.0	18.75	5.0	8.0	0.11	33.0	D	T210D336μ035μS	M,P	2.0	20.0	25.00	3.0	5.0	0.17
120.0	C	T210C127μ010μS	R,S	1.5	15.0	18.75	5.0	8.0	0.10	39.0	D	T210D396μ035μS	M,P	2.0	20.0	25.00	4.0	6.0	0.15
150.0	D	T210D157μ010μS	R,S	2.0	20.0	25.00	5.0	8.0	0.09	47.0	D	T210D476μ035μS	M,P	3.0	30.0	37.50	4.0	6.0	0.14
180.0	D	T210D187μ010μS	R,S	2.0	20.0	25.00	5.0	8.0	0.08	<b>50 VOLT RATING AT 85°C—33 VOLT RATING AT 125°C</b>									
220.0	D	T210D227μ010μS	R,S	3.0	30.0	37.50	5.0	8.0	0.07	0.0047	A	T210A472μ050μS	R,S	0.05	0.5	.63	2.0	4.0	30.00
<b>15 VOLT RATING AT 85°C—10 VOLT RATING AT 125°C</b>										0.0056	A	T210A562μ050μS	R,S	0.05	0.5	.63	2.0	4.0	28.00
1.2	A	T210A125μ015μS	R,S	0.25	2.5	3.13	3.0	4.0	1.40	0.0068	A	T210A682μ050μS	R,S	0.05	0.5	.63	2.0	4.0	26.00
1.5	A	T210A155μ015μS	R,S	0.25	2.5	3.13	3.0	4.0	1.30	0.0082	A	T210A822μ050μS	R,S	0.05	0.5	.63	2.0	4.0	24.00
1.8	A	T210A185μ015μS	R,S	0.25	2.5	3.13	3.0	4.0	1.25	0.01	A	T210A103μ050μS	R,S	0.05	0.5	.63	2.0	4.0	22.00
2.2	A	T210A225μ015μS	R,S	0.25	2.5	3.13	3.0	4.0	1.20	0.012	A	T210A123μ050μS	R,S	0.05	0.5	.63	2.0	4.0	20.00
2.7	A	T210A275μ015μS	P,R	0.25	2.5	3.13	3.0	4.0	1.20	0.015	A	T210A153μ050μS	R,S	0.05	0.5	.63	2.0	4.0	18.00
3.3	A	T210A335μ015μS	P,R	0.25	2.5	3.13	3.0	4.0	1.00	0.018	A	T210A183μ050μS	R,S	0.05	0.5	.63	2.0	4.0	16.00
5.6	B	T210B565μ015μS	R,S	0.5	5.0	6.25	4.0	6.0	0.47	0.022	A	T210A223μ050μS	R,S	0.05	0.5	.63	2.0	4.0	14.00
6.8	B	T210B685μ015μS	R,S	0.5	5.0	6.25	4.0	6.0	0.43	0.027	A	T210A273μ050μS	R,S	0.05	0.5	.63	2.0	4.0	13.00
8.2	B	T210B825μ015μS	R,S	0.5	5.0	6.25	4.0	6.0	0.39	0.033	A	T210A333μ050μS	R,S	0.05	0.5	.63	2.0	4.0	12.00
10.0	B	T210B106μ015μS	R,S	0.5	5.0	6.25	4.0	6.0	0.35	0.039	A	T210A393μ050μS	R,S	0.05	0.5	.63	2.0	4.0	11.00
12.0	B	T210B126μ015μS	R,S	0.5	5.0	6.25	4.0	6.0	0.32	0.047	A	T210A473μ050μS	R,S	0.05	0.5	.63	2.0	4.0	10.00
15.0	B	T210B156μ015μS	R,S	0.5	5.0	6.25	4.0	6.0	0.29	0.056	A	T210A563μ050μS	R,S	0.05	0.5	.63	2.0	4.0	9.00
18.0	B	T210B186μ015μS	P,R	0.5	5.0	6.25	4.0	6.0	0.27	0.068	A	T210A683μ050μS	R,S	0.05	0.5	.63	2.0	4.0	8.00
22.0	B	T210B226μ015μS	P,R	0.5	5.0	6.25	4.0	6.0	0.26	0.082	A	T210A823μ050μS	R,S	0.05	0.5	.63	2.0	4.0	7.50
27.0	C	T210C276μ015μS	R,S	1.5	15.0	18.75	4.0	6.0	0.21	0.1	A	T210A104μ050μS	R,S	0.1	1.0	1.25	2.0	4.0	7.00
33.0	C	T210C336μ015μS	R,S	1.5	15.0	18.75	4.0	6.0	0.19	0.12	A	T210A124μ050μS	R,S	0.1	1.0	1.25	2.0	4.0	6.50
39.0	C	T210C396μ015μS	P,R	1.5	15.0	18.75	4.0	6.0	0.17	0.15	A	T210A154μ050μS	R,S	0.1	1.0	1.25	2.0	4.0	5.50
47.0	C	T210C476μ015μS	P,R	1.5	15.0	18.75	4.0	6.0	0.16	0.18	A	T210A184μ050μS	R,S	0.1	1.0	1.25	2.0	4.0	5.00
56.0	C	T210C566μ015μS	P,R	1.5	15.0	18.75	4.0	6.0	0.15	0.22	A	T210A224μ050μS	R,S	0.1	1.0	1.25	2.0	4.0	4.00
68.0	C	T210C686μ015μS	P,R	1.5	15.0	18.75	4.0	6.0	0.13	0.27	A	T210A274μ050μS	R,S	0.1	1.0	1.25	2.0	4.0	3.50
82.0	D	T210D826μ015μS	P,R	2.0	20.0	25.00	5.0	8.0	0.11	0.33	A	T210A334μ050μS	R,S	0.1	1.0	1.25	2.0	4.0	3.30
100.0	D	T210D107μ015μS	P,R	2.0	20.0	25.00	5.0	8.0	0.10	0.39	A	T210A394μ050μS	R,S	0.1	1.0	1.25	2.0	4.0	3.30
120.0	D	T210D127μ015μS	P,R	2.0	20.0	25.00	5.0	8.0	0.09	0.47	A	T210A474μ050μS	R,S	0.1	1.0	1.25	2.0	4.0	3.00
150.0	D	T210D157μ015μS	P,R	3.0	30.0	37.50	5.0	8.0	0.09	0.56	A	T210A564μ050μS	R,S	0.1	1.0	1.25	2.0	4.0	2.50
<b>20 VOLT RATING AT 85°C—13 VOLT RATING AT 125°C</b>																			
1.2	A	T210A12510202S	P,R	0.25	2.5	3.13	3.0	4.0	1.40										
1.5	A	T210A15510202S	P,R	0.25	2.5	3.13	3.0	4.0	1.30										
1.8	A	T210A18510202S	P,R	0.25	2.5	3.13	3.0	4.0	1.25										
2.2	A	T210A22510202S	P,R	0.25	2.5	3.13	3.0	4.0	1.20										

(1) To complete Part Number, insert Capacitance Tolerance Symbol in 9th character, M— ±20%, K— ±10%, J— ±5%.

(2) To complete Part Number, insert Failure Rate Symbol in the 13th character as shown on page 3.

**DETAIL SPECIFICATION**  
**GR500/T210 Capacitors**

NOMINAL CAPACITANCE (μF) 25°C 120 Hz	CASE SIZE	PART NUMBER	GRADED FAILURE RATES	MAXIMUM LEAKAGE CURRENT AT RATED VOLTS			MAXIMUM DISSIPATION FACTOR (% AT 120 Hz)		ESR MAXIMUM OHMS 100 kHz +25°C	NOMINAL CAPACITANCE (μF) 25°C 120 Hz	CASE SIZE	PART NUMBER	GRADED FAILURE RATES	MAXIMUM LEAKAGE CURRENT AT RATED VOLTS			MAXIMUM DISSIPATION FACTOR (% AT 120 Hz)		ESR MAXIMUM OHMS 100 kHz +25°C
				+25°C (μA)	+85°C (μA)	+125°C (μA)	-55° +25°C	+85° +125°C						+25°C (μA)	+85°C (μA)	+125°C (μA)	-55° +25°C	+85° +125°C	
<b>50 VOLT RATING AT 85°C—33 VOLT RATING AT 125°C (CONT'D.)</b>										<b>75 VOLT RATING AT 85°C—50 VOLT RATING AT 125°C (CONT'D.)</b>									
0.68	A	T210A684μ050μS	R,S	0.1	1.0	1.25	2.0	4.0	1.80	1.8	B	T210B185μ075μS	P,R	0.5	5.0	6.25	2.0	4.0	0.92
0.82	A	T210A824μ050μS	P,R	0.1	1.0	1.25	2.0	4.0	1.60	2.2	B	T210B225μ075μS	P,R	0.5	5.0	6.25	2.0	4.0	0.80
1.0	A	T210A105μ050μS	P,R	0.1	1.0	1.25	2.0	4.0	1.40	2.7	B	T210B275μ075μS	M,P	0.5	5.0	6.25	2.0	4.0	0.68
1.2	B	T210B125μ050μS	R,S	0.25	2.5	3.13	2.0	4.0	1.20	3.3	B	T210B335μ075μS	M,P	0.75	7.5	9.40	2.0	4.0	0.62
1.5	B	T210B155μ050μS	R,S	0.25	2.5	3.13	2.0	4.0	1.10	3.9	B	T210B395μ075μS	M,P	0.75	7.5	9.40	2.0	4.0	0.56
1.8	B	T210B185μ050μS	R,S	0.25	2.5	3.13	2.0	4.0	0.92	4.7	C	T210C475μ075μS	P,R	1.5	15.0	18.75	3.0	4.0	0.47
2.2	B	T210B225μ050μS	R,S	0.25	2.5	3.13	2.0	4.0	0.80	5.6	C	T210C565μ075μS	P,R	1.5	15.0	18.75	3.0	4.0	0.44
2.7	B	T210B275μ050μS	P,R	0.25	2.5	3.13	2.0	4.0	0.68	6.8	C	T210C685μ075μS	M,P	2.0	20.0	25.00	3.0	4.0	0.44
3.3	B	T210B335μ050μS	P,R	0.5	5.0	6.25	2.0	4.0	0.62	8.2	C	T210C825μ075μS	M,P	2.0	20.0	25.00	3.0	5.0	0.36
3.9	B	T210B395μ050μS	P,R	0.5	5.0	6.25	2.0	4.0	0.56	10.0	C	T210C106μ075μS	M,P	2.0	20.0	25.00	3.0	5.0	0.33
4.7	B	T210B475μ050μS	M,P	0.5	5.0	6.25	2.0	4.0	0.51	12.0	D	T210D126μ075μS	M,P	2.5	25.0	31.25	3.0	5.0	0.26
5.6	C	T210C565μ050μS	P,R	1.5	15.0	18.75	3.0	4.0	0.44	15.0	D	T210D156μ075μS	M,P	2.5	25.0	31.25	3.0	5.0	0.23
6.8	C	T210C685μ050μS	P,R	1.5	15.0	18.75	3.0	5.0	0.40	<b>100 VOLT RATING AT 85°C—67 VOLT RATING AT 125°C</b>									
8.2	C	T210C825μ050μS	P,R	1.5	15.0	18.75	3.0	5.0	0.36	0.0047	A	T210A472μ100μS	M,P	0.1	1.0	1.25	2.0	4.0	30.00
10.0	C	T210C106μ050μS	P,R	1.5	15.0	18.75	3.0	5.0	0.33	0.0056	A	T210A562μ100μS	M,P	0.1	1.0	1.25	2.0	4.0	28.00
12.0	C	T210C126μ050μS	M,P	1.5	15.0	18.75	3.0	5.0	0.30	0.0068	A	T210A682μ100μS	M,P	0.1	1.0	1.25	2.0	4.0	26.00
15.0	C	T210C156μ050μS	M,P	1.5	15.0	18.75	3.0	5.0	0.27	0.0082	A	T210A822μ100μS	M,P	0.1	1.0	1.25	2.0	4.0	24.00
18.0	C	T210C186μ050μS	M,P	1.5	15.0	18.75	3.0	5.0	0.25	0.01	A	T210A103μ100μS	M,P	0.1	1.0	1.25	2.0	4.0	22.00
22.0	D	T210D226μ050μS	M,P	2.0	20.0	25.00	3.0	5.0	0.20	0.012	A	T210A123μ100μS	M,P	0.1	1.0	1.25	2.0	4.0	20.00
<b>75 VOLT RATING AT 85°C—50 VOLT RATING AT 125°C</b>										0.015	A	T210A153μ100μS	M,P	0.1	1.0	1.25	2.0	4.0	18.00
0.0047	A	T210A472μ075μS	P,R	0.1	1.0	1.25	2.0	4.0	30.00	0.018	A	T210A183μ100μS	M,P	0.1	1.0	1.25	2.0	4.0	16.00
0.0056	A	T210A562μ075μS	P,R	0.1	1.0	1.25	2.0	4.0	28.00	0.022	A	T210A223μ100μS	M,P	0.1	1.0	1.25	2.0	4.0	14.00
0.0068	A	T210A682μ075μS	P,R	0.1	1.0	1.25	2.0	4.0	26.00	0.027	A	T210A273μ100μS	M,P	0.1	1.0	1.25	2.0	4.0	13.00
0.0082	A	T210A822μ075μS	P,R	0.1	1.0	1.25	2.0	4.0	24.00	0.033	A	T210A333μ100μS	M,P	0.1	1.0	1.25	2.0	4.0	12.00
0.01	A	T210A103μ075μS	P,R	0.1	1.0	1.25	2.0	4.0	22.00	0.039	A	T210A393μ100μS	M,P	0.1	1.0	1.25	2.0	4.0	11.00
0.012	A	T210A123μ075μS	P,R	0.1	1.0	1.25	2.0	4.0	20.00	0.047	A	T210A473μ100μS	M,P	0.1	1.0	1.25	2.0	4.0	10.00
0.015	A	T210A153μ075μS	P,R	0.1	1.0	1.25	2.0	4.0	18.00	0.056	A	T210A563μ100μS	M,P	0.1	1.0	1.25	2.0	4.0	9.00
0.018	A	T210A183μ075μS	P,R	0.1	1.0	1.25	2.0	4.0	16.00	0.068	A	T210A683μ100μS	M,P	0.1	1.0	1.25	2.0	4.0	8.00
0.022	A	T210A223μ075μS	P,R	0.1	1.0	1.25	2.0	4.0	14.00	0.082	A	T210A823μ100μS	M,P	0.1	1.0	1.25	2.0	4.0	7.50
0.027	A	T210A273μ075μS	P,R	0.1	1.0	1.25	2.0	4.0	13.00	0.1	A	T210A104μ100μS	M,P	0.25	2.5	3.13	2.0	4.0	7.00
0.033	A	T210A333μ075μS	P,R	0.1	1.0	1.25	2.0	4.0	12.00	0.12	A	T210A124μ100μS	M,P	0.25	2.5	3.13	2.0	4.0	6.50
0.039	A	T210A393μ075μS	P,R	0.1	1.0	1.25	2.0	4.0	11.00	0.15	A	T210A154μ100μS	M,P	0.25	2.5	3.13	2.0	4.0	4.40
0.047	A	T210A473μ075μS	P,R	0.1	1.0	1.25	2.0	4.0	10.00	0.18	A	T210A184μ100μS	M,P	0.25	2.5	3.13	2.0	4.0	4.00
0.056	A	T210A563μ075μS	P,R	0.1	1.0	1.25	2.0	4.0	9.00	0.22	A	T210A224μ100μS	M,P	0.25	2.5	3.13	2.0	4.0	3.50
0.068	A	T210A683μ075μS	P,R	0.1	1.0	1.25	2.0	4.0	8.00	0.27	A	T210A274μ100μS	M,P	0.25	2.5	3.13	2.0	4.0	3.10
0.082	A	T210A823μ075μS	P,R	0.1	1.0	1.25	2.0	4.0	7.50	0.33	A	T210A334μ100μS	M,P	0.25	2.5	3.13	2.0	4.0	2.80
0.1	A	T210A104μ075μS	P,R	0.25	2.5	3.13	2.0	4.0	7.00	0.39	A	T210A394μ100μS	M,P	0.25	2.5	3.13	2.0	4.0	2.60
0.12	A	T210A124μ075μS	P,R	0.25	2.5	3.13	2.0	4.0	6.50	0.47	A	T210A474μ100μS	M,P	0.25	2.5	3.13	2.0	4.0	2.40
0.15	A	T210A154μ075μS	P,R	0.25	2.5	3.13	2.0	4.0	4.40	0.56	A	T210A564μ100μS	M,P	0.25	2.5	3.13	2.0	4.0	2.25
0.18	A	T210A184μ075μS	P,R	0.25	2.5	3.13	2.0	4.0	4.00	0.68	B	T210B684μ100μS	M,P	0.25	2.5	3.13	2.0	4.0	2.10
0.22	A	T210A224μ075μS	P,R	0.25	2.5	3.13	2.0	4.0	3.50	0.82	B	T210B824μ100μS	M,P	0.25	2.5	3.13	2.0	4.0	1.47
0.27	A	T210A274μ075μS	P,R	0.25	2.5	3.13	2.0	4.0	3.10	1.0	B	T210B105μ100μS	M,P	0.25	2.5	3.13	2.0	4.0	1.40
0.33	A	T310A334μ075μS	P,R	0.25	2.5	3.13	2.0	4.0	2.80	1.2	B	T210B125μ100μS	M,P	0.25	2.5	3.13	2.0	4.0	1.33
0.39	A	T310A394μ075μS	P,R	0.25	2.5	3.13	2.0	4.0	2.60	1.5	B	T210B155μ100μS	M,P	0.5	5.0	6.25	2.0	4.0	1.06
0.47	A	T210A474μ075μS	P,R	0.25	2.5	3.13	2.0	4.0	2.40	1.8	B	T210B185μ100μS	M,P	0.5	5.0	6.25	2.0	4.0	0.92
0.56	A	T210A564μ075μS	P,R	0.25	2.5	3.13	2.0	4.0	2.25	2.2	B	T210B225μ100μS	M,P	0.5	5.0	6.25	2.0	4.0	0.80
0.68	A	T210A684μ075μS	M,P	0.25	2.5	3.13	2.0	4.0	2.10	2.7	B	T210B275μ100μS	M,P	0.5	5.0	6.25	2.0	4.0	0.68
0.82	B	T210B824μ075μS	P,R	0.25	2.5	3.13	2.0	4.0	1.47	3.3	C	T210C335μ100μS	M,P	2.0	20.0	25.00	3.0	5.0	0.62
1.0	B	T210B105μ075μS	P,R	0.25	2.5	3.13	2.0	4.0	1.40	3.9	C	T210C395μ100μS	M,P	2.0	20.0	25.00	3.0	5.0	0.56
1.2	B	T210B125μ075μS	P,R	0.25	2.5	3.13	2.0	4.0	1.33	4.7	C	T210C475μ100μS	M,P	2.0	20.0	25.00	3.0	5.0	0.47
1.5	B	T210B155μ075μS	P,R	0.5	5.0	6.25	2.0	4.0	1.06	5.6	C	T210C565μ100μS	M,P	2.0	20.0	25.00	3.0	5.0	0.44
										6.8	C	T210C685μ100μS	M	2.0	20.0	25.00	3.0	5.0	0.40
										8.2	D	T210D825μ100μS	M	2.5	25.0	31.25	3.0	5.0	0.36
										10.0	D	T210D106μ100μS	M	2.5	25.0	31.25	3.0	5.0	0.33

(1) To complete Part Number, insert Capacitance Tolerance Symbol in 9th character, M—±20%, K—±10%, J—±5%.  
(2) To complete Part Number, insert Failure Rate Symbol in the 13th character as shown on page 3.

**CAPACITOR MARKINGS**

**A Case**

+T210 —Polarity symbol, series designation  
K10%S —KEMET tolerance, failure rate  
R68 μF —Capacitance  
50 V —Voltage  
225XA —Date Code (Year and week of manufacture and batch designator)

**B Case**

+KT210B —Polarity symbol, KEMET part number  
475K050 —KEMET part number (continued)  
SS4R7 μF —KEMET part number (continued), capacitance  
50 V 10% —Voltage, tolerance  
0225XA —Date Code (Year and week of manufacture and batch designator)

**C Case**

+KEMET —Polarity symbol, KEMET  
T210C106K —KEMET part number  
035SS 10% —KEMET part number (continued), tolerance  
10 μF 35V —Capacitance, voltage  
0225XA —Date Code (Year and week of manufacture and batch designator)

## APPLICATIONS INFORMATION GR500/T210

**Introduction** — The following section is provided for assistance in the application of **T210** Series capacitors. Space does not permit a complete discussion of all technical aspects, and further information on specific problems may be obtained through KEMET sales representatives.

**Capacitance** — The nominal values listed in Table 1 conforms to accepted industry practice; intermediate values may be produced on special order. Standard tolerances are  $\pm 20\%$ ,  $\pm 10\%$ , and  $\pm 5\%$ . Closer tolerances of  $\pm 2\%$  may be available upon special order and after agreement upon measurement conditions.

The capacitance of solid tantalum capacitors decreases with frequency as shown in Figure 1. The nominal values of Table 1 are also available at 1 kHz on special order. Typical variation of capacitance with respect to temperature is illustrated in Figure 2.

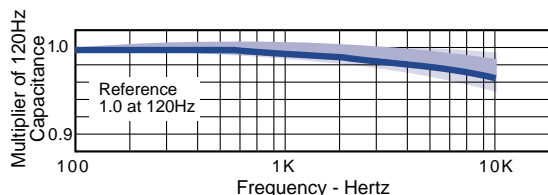

Fig 1 Capacitance Versus Frequency

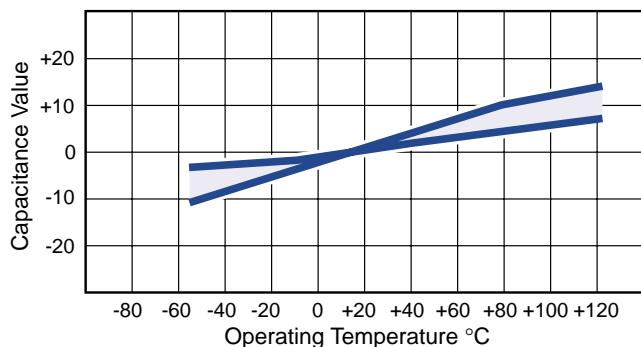

Fig 2 Capacitance Versus Temperature

**Dissipation Factor** — Dissipation factor is defined as the ratio of equivalent series resistance to capacitive reactance at a specified frequency:

$$D = \frac{R}{X_c} = 2\pi fCR$$

Where  $R$  = equivalent series resistance in ohms  
 $D$  = dissipation factor  
 $X_c$  = capacitive reactance in ohms  
 $C$  = series capacitance in farads  
 $f$  = frequency in Hertz

Unless otherwise stated, a standard frequency of 120 Hz is used for both dissipation and capacitance measurements. Typical behavior of dissipation factor with frequency is shown in Figure 3. Dissipation factor loses its importance as

a measurement parameter at higher frequencies, where impedance and ESR are the normal parameters of concern.

### TYPICAL DISSIPATION FACTOR AS A FUNCTION OF FREQUENCY AT + 25° C POLAR CAPACITORS - T210 SERIES

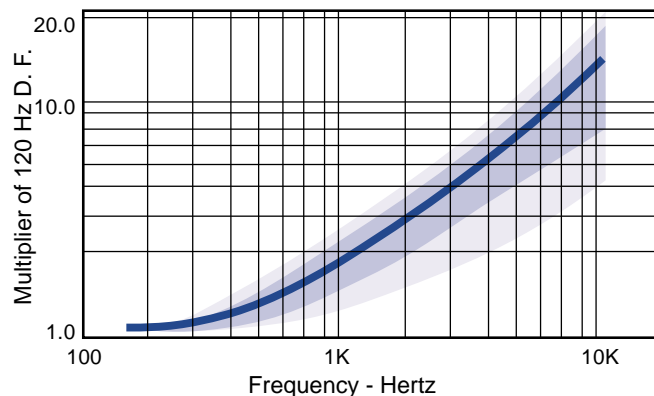

Fig 3 Frequency - Hertz

**DC Leakage Current** — The DC Leakage current limits of Table I are the lowest generally specified in the solid tantalum industry. Even lower leakage currents are available on special order. Low leakage current, aside from its intrinsic value, is an indication of anode quality. DC leakage current as a function of temperature is represented by the typical curve in Figure 4, while similar information pertaining to leakage behavior with respect to voltage is contained in Figure 5.

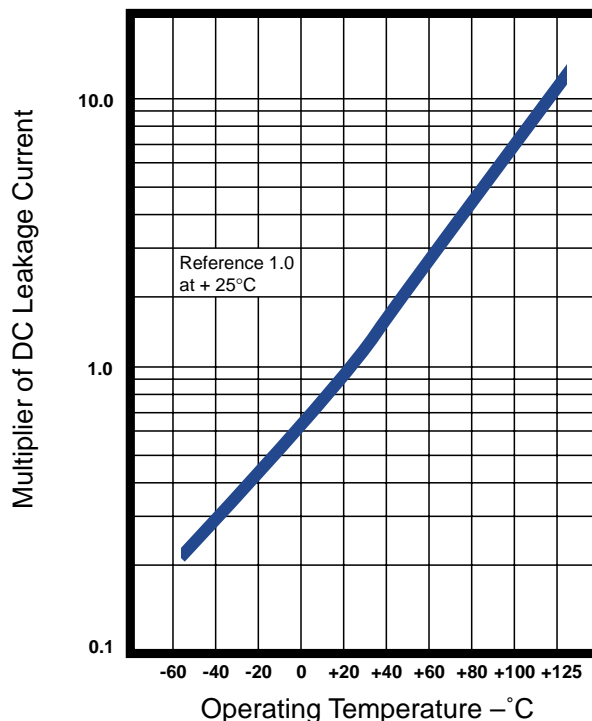

Fig 4 Typical Variation of leakage current with temperature.

APPLICATIONS INFORMATION GR500/T210 (Continued)

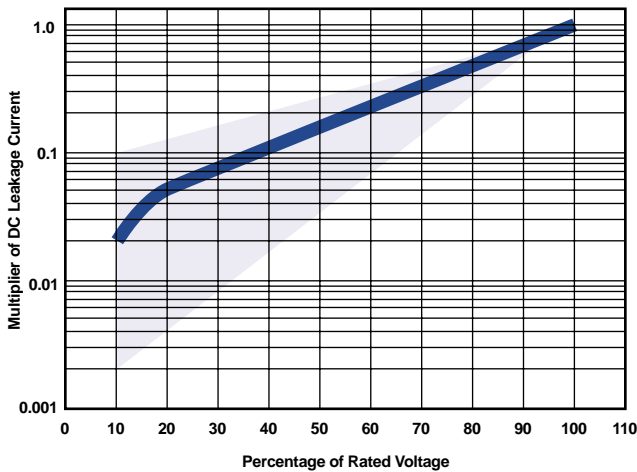

Fig 5 Typical variation of leakage current with voltage

**Voltage and Temperature Ratings; Reliability Effect — T210 Series capacitors** are manufactured in 6 through 100 volt ratings at 85°C. Operation at 125°C with 2/3 rated voltage applied gives equivalent results and voltage may be derated linearly between these two points. Solid tantalum capacitors may be operated continuously at any voltage from zero to the maximum rating without adverse effects. Operation at voltage below nameplate improves reliability, while subsequent operation at a higher voltage will not be affected by prior low voltage use.

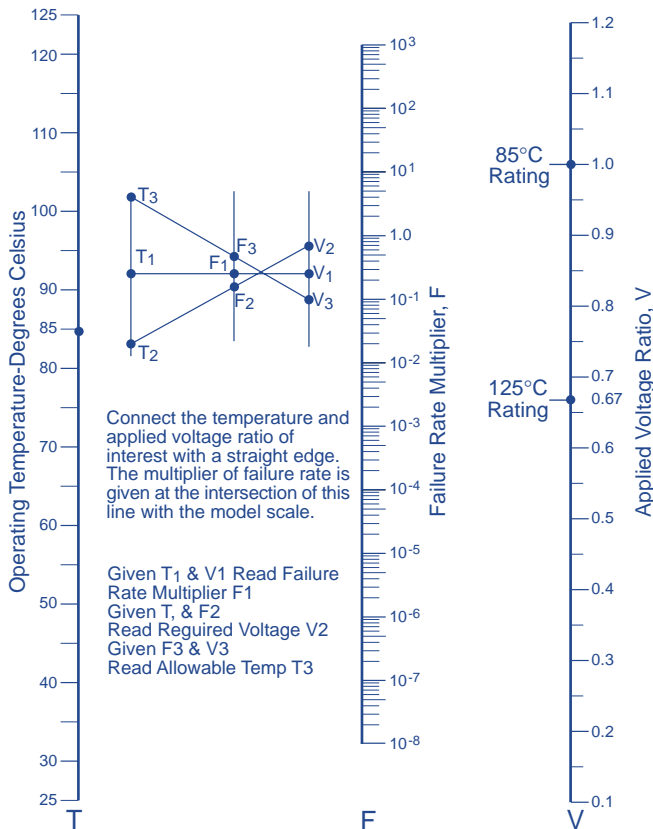

Fig 6 Reliability alignment chart

Expected reliability factors for voltages and temperatures other than the rated conditions may be found in Figure 6. Since **T210 Series** capacitors are supplied with a predetermined failure rate under rated conditions, reliability under use conditions may be estimated with this nomograph.

**Circuit Impedance** — Failure rates are affected by temperature and voltage as described in Figure 6 and also by the circuit impedance seen by the capacitor. Originally, application advice for solid tantalum capacitors suggested an impedance of 3 ohms or higher per applied volt. This advice was later found to be unnecessarily conservative, and the factors below are based on 0.1 ohm per volt as the unity failure rate multiplier.

Circuit Impedance, Ohms per Volt	Failure Rate Multiplying Factor
0.1	1.0
0.2	0.8
0.4	0.6
0.6	0.4
0.8	0.3
1	0.2
2	0.1
≥3	0.07

**Equivalent Series Resistance** — The equivalent series resistance (ESR) of a solid tantalum capacitor is frequency dependent as shown in Figure 7a thru 7g. The curves are typical of the capacitor values noted, with measurements being made by contacting lead wires 1/4 inch from the ends of the capacitor cases. Since ESR decreases with frequency, AC performance at higher frequencies is considerably better than would be predicted from the 120 Hz ratings.

**Capacitor Impedance** — The relationship between impedance and frequency at various voltage ratings is illustrated with typical curves in Figure 7. Impedance declines with decreasing capacitive reactance, but ESR becomes dominant before the self-resonant point is reached, producing the typical damped curves. Finally, impedance increases as inductance of the lead wire and other capacitor elements dominates. Obviously, high frequency impedance is directly influenced by the length of lead wire and general mounting configuration. The typical curves of Figure 7 include 1/4 inch of lead wire at each end of the capacitor.

**AC Ripple** — Permissible AC ripple voltage is related to the rated voltage, the ESR of the capacitor, and the power dissipation capability of a particular case size:

1. The positive peak AC voltage plus the DC bias voltage (if any), must not exceed the rated voltage.
2. The negative peak AC voltage, in combination with the bias voltage (if any), must not exceed that allowable for a polar **T210** capacitor (see Table III).



## APPLICATIONS INFORMATION GR500/T210 (Continued)

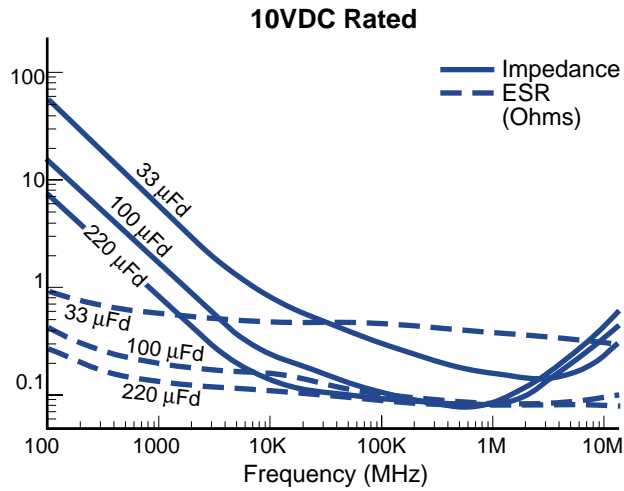

Figure 7a. ESR and Impedance vs. Frequency

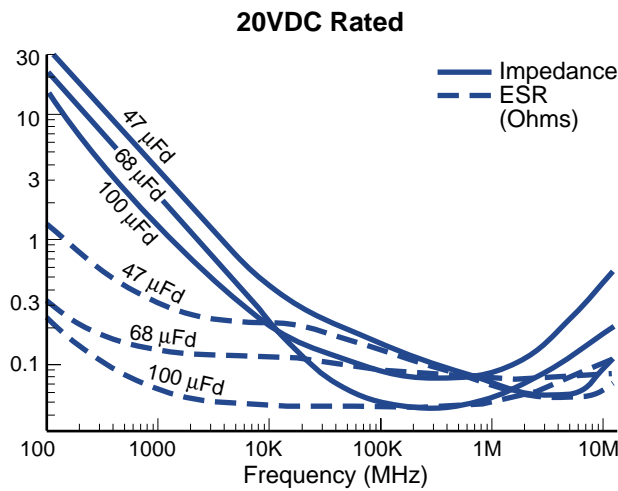

Figure 7b. ESR and Impedance vs. Frequency

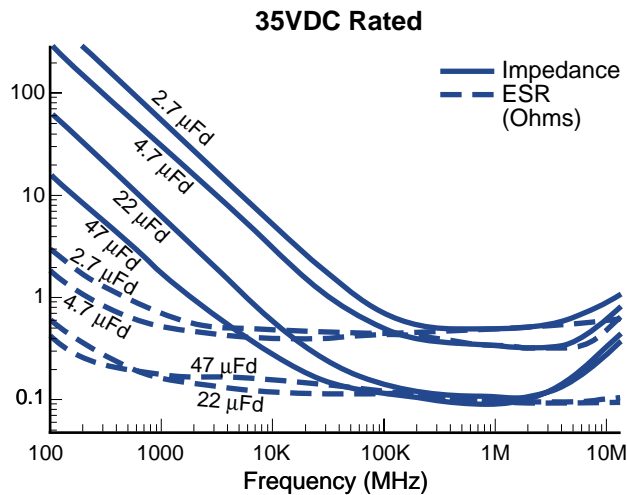

Figure 7c. ESR and Impedance vs. Frequency

**APPLICATIONS INFORMATION GR500/T210 (Continued)**

3. The power dissipated in the equivalent series resistance of the capacitor must not exceed the limits specified in Table II.

The power dissipated may be calculated from the following:

$$P = \frac{E^2 R}{Z^2}$$

Where E = ripple voltage across capacitor in rms volts  
 Z = capacitor impedance in ohms at the specified frequency (typical values from Figure 7)  
 R = equivalent series resistance in ohms (typical values from Figure 7)

Ripple voltage, as limited by power dissipation, may be determined as follows:

$$E_{\max}(25^\circ\text{C}) = Z \sqrt{\frac{P_{\max}}{R}}$$

Where P max=maximum permissible power from Table III

R = ESR from Figure 7  
 E max (85°C) = 0.9 E max (25°C)  
 E max (125°C) = 0.4 E max (25°C)

**TABLE II**

**Maximum Permissible Power Dissipation at 25°C Ambient**

T210 Polar Capacitors	
Case Size	Watts
A	0.090
B	0.100
C	0.125
D	0.180

**Reverse Voltage** — The solid tantalum capacitor is basically a polar device and can be damaged by serious reversals of polarity even for short periods of time, depending upon the circuit impedance. However, some short duration reversal is permissible as shown in Table III.

**TABLE III**

**Permissible Reverse Voltage**

Temp. °C	% of Forward Rated Voltage
25	15
85	5
125	1

**Shelf Life** — Shelf life is particularly difficult to define for the solid tantalum capacitor. Extended periods of storage at high temperature will cause some small change in leakage current which usually returns to normal upon short time application of working voltage. Storage at low temperatures causes little or no degradation of leakage current. Long-term studies of capacitance and dissipation factor shift for as long as 45,000 hours indicate only minor variations (usually less than 2%) in these parameters.

**Installation** — Mounting procedures should not place undue strain on terminals, particularly the positive end with its glass-metal seal. Attention to soldering technique should avoid excessive heat transfer which might remelt the capacitor's internal solder and cause loss of hermeticity or short circuits. Potting materials should not produce excessive curing exotherms or shrinkage pressures.

# DETAIL SPECIFICATION

## GR500/T240 Capacitors

### CAPACITOR OUTLINE DRAWINGS

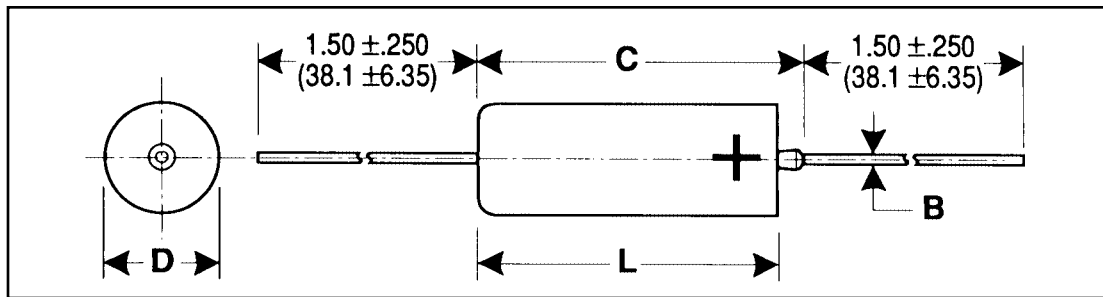

### DIMENSIONS — INCHES & (MILLIMETERS)

CASE SIZE	UNINSULATED		INSULATED		B ±0.001 ±(.03)	C MAX.
	D ±0.005 ±(.13)	L ±0.031 ±(.79)	D ±0.010 ±(.25)	L ±0.031 ±(.79)		
A	0.125 (3.18)	0.250 (6.35)	0.135 (3.43)	0.286 (7.26)	0.020 (.51)	0.422 (10.72)
B	0.175 (4.45)	0.438 (11.13)	0.185 (4.70)	0.474 (12.04)	0.020 (.51)	0.610 (15.49)
C	0.279 (7.09)	0.650 (16.51)	0.289 (7.34)	0.686 (17.42)	0.025 (.64)	0.822 (20.88)
D	0.341 (8.66)	0.750 (19.05)	0.351 (8.92)	0.786 (19.96)	0.025 (.64)	0.922 (23.42)

### T240 ORDERING INFORMATION

**T 240 A 125 K 050 R S**

**TANTALUM**

**SERIES**

240—GR500/J (KEMET) High Reliability; Solid Electrolyte. Graded; High Reliability; Hermetic Seal; Axial Lead; Polar

**CASE SIZE**

A/B/C/D

**PICOFARAD CODE**

First two digits represent significant figures. Third digit specifies number of zeros to follow.

**CAPACITANCE TOLERANCE**

M— ±20%  
K— ±10%  
J— ±5%

**LEAD MATERIAL**

S—Standard  
(Solder coated nickel)

**GRADED FAILURE RATE**

M—1%/k hrs.  
P—0.1%/k hrs.  
R—0.01%/k hrs.

**VOLTAGE**

at 85°C

## DETAIL SPECIFICATION

# GR500/T240 Capacitors

### RATINGS & PART NUMBER REFERENCE

NOMINAL CAPACITANCE (μF) 25°C 120 Hz	CASE SIZE	PART NUMBER	GRADED FAILURE RATES	MAXIMUM LEAKAGE CURRENT AT RATED VOLTS			MAXIMUM DISSIPATION FACTOR (%) AT 120 Hz		ESR MAXIMUM OHMS 100 kHz +25°C	NOMINAL CAPACITANCE (μF) 25°C 120 Hz	CASE SIZE	PART NUMBER	GRADED FAILURE RATES	MAXIMUM LEAKAGE CURRENT AT RATED VOLTS			MAXIMUM DISSIPATION FACTOR (%) AT 120 Hz		ESR MAXIMUM OHMS 100 kHz +25°C
				+25°C (μA)	+85°C (μA)	+125°C (μA)	-55°C +25°C	+85°C +125°C						+25°C (μA)	+85°C (μA)	+125°C (μA)	-55°C +25°C	+85°C +125°C	
<b>6 VOLT RATING AT 85°C—4 VOLT RATING AT 125°C</b>										<b>30 VOLT RATING AT 85°C—20 VOLT RATING AT 125°C</b>									
10.0	A	T240A106μ006μ2S	P,R	0.5	2.0	6.25	5.0	6.0	0.700	1.8	A	T240A185μ030μ2S	P,R	0.5	2.0	6.25	3.0	4.0	1.25
12.0	A	T240A126μ006μ2S	P,R	0.5	2.0	6.25	5.0	6.0	0.600	2.2	A	T240A225μ030μ2S	M,P	0.5	2.0	6.25	3.0	4.0	1.20
100.0	B	T240B107μ006μ2S	P,R	1.0	3.0	12.50	6.0	8.0	0.200	2.7	A	T240A275μ030μ2S	M,P	0.5	2.0	6.25	3.0	4.0	1.10
220.0	C	T240C227μ006μ2S	P,R	2.0	8.0	25.00	6.0	8.0	0.090	12.0	B	T240B126μ030μ2S	M,P	1.0	5.0	12.50	4.0	6.0	0.32
270.0	C	T240C277μ006μ2S	P,R	2.0	8.0	25.00	6.0	8.0	0.070	15.0	B	T240B156μ030μ2S	M,P	1.0	5.0	12.50	4.0	6.0	0.29
330.0	C	T240C337μ006μ2S	P,R	2.0	8.0	25.00	6.0	8.0	0.065	18.0	B	T240B186μ030μ2S	M,P	1.0	5.0	12.50	4.0	6.0	0.27
390.0	C	T240C397μ006μ2S	P,R	2.0	8.0	25.00	8.0	10.0	0.065	56.0	C	T240C566μ030μ2S	M,P	1.0	5.0	12.50	4.0	6.0	0.15
470.0	C	T240C477μ006μ2S	P,R	2.0	8.0	25.00	8.0	10.0	0.060	68.0	C	T240C686μ030μ2S	M,P	2.0	15.0	25.00	4.0	6.0	0.13
680.0	D	T240D687μ006μ2S	P,R	5.0	10.0	62.50	8.0	10.0	0.060	82.0	D	T240D826μ030μ2S	M	2.5	20.0	31.25	5.0	6.0	0.11
820.0	D	T240D827μ006μ2S	P,R	5.0	10.0	62.50	8.0	10.0	0.055	100.0	D	T240D107μ030μ2S	M	2.5	20.0	31.25	5.0	6.0	0.10
1000.0	D	T240D108μ006μ2S	P,R	5.0	10.0	62.50	8.0	10.0	0.050	<b>35 VOLT RATING AT 85°C—20 VOLT RATING AT 125°C</b>									
<b>10 VOLT RATING AT 85°C—7 VOLT RATING AT 125°C</b>										<b>50 VOLT RATING AT 85°C—33 VOLT RATING AT 125°C</b>									
6.8	A	T240A685μ010μ2S	P,R	0.5	2.0	6.25	4.0	6.0	0.80	1.2	A	T240A125μ035μ2S	P,R	0.5	2.0	6.25	3.0	4.0	1.30
8.2	A	T240A825μ010μ2S	P,R	0.5	2.0	6.25	4.0	6.0	0.70	1.5	A	T240A155μ035μ2S	P,R	0.5	2.0	6.25	3.0	4.0	1.20
47.0	B	T240B476μ010μ2S	P,R	1.0	2.0	6.25	5.0	6.0	0.22	1.8	A	T240A185μ035μ2S	M,P	0.5	2.0	6.25	3.0	4.0	1.20
56.0	B	T240B566μ010μ2S	P,R	1.0	4.0	12.50	5.0	6.0	0.20	8.2	B	T240B825μ035μ2S	M,P	1.0	2.0	12.50	4.0	6.0	0.40
68.0	B	T240B686μ010μ2S	P,R	1.0	4.0	12.50	5.0	6.0	0.18	10.0	B	T240B106μ035μ2S	M,P	1.0	2.0	12.50	4.0	6.0	0.35
82.0	B	T240B826μ010μ2S	P,R	1.0	4.0	12.50	5.0	6.0	0.15	27.0	C	T240C276μ035μ2S	M,P	1.0	5.0	12.50	5.0	6.0	0.19
150.0	C	T240C157μ010μ2S	P,R	1.0	7.0	12.50	6.0	8.0	0.10	33.0	C	T240C336μ035μ2S	M,P	1.0	5.0	12.50	5.0	6.0	0.19
180.0	C	T240C187μ010μ2S	P,R	1.0	7.0	12.50	6.0	8.0	0.090	39.0	C	T240C396μ035μ2S	M,P	1.0	5.0	12.50	5.0	6.0	0.17
220.0	C	T240C227μ010μ2S	P,R	1.0	7.0	12.50	6.0	8.0	0.090	47.0	C	T240C476μ035μ2S	M,P	1.0	5.0	12.50	5.0	6.0	0.15
270.0	C	T240C277μ010μ2S	P,R	2.0	10.0	25.00	6.0	8.0	0.075	56.0	D	T240D566μ035μ2S	M	2.0	10.0	25.00	5.0	6.0	0.13
330.0	D	T240D337μ010μ2S	P,R	2.0	16.0	25.00	8.0	10.0	0.070	68.0	D	T240D686μ035μ2S	M	2.0	10.0	25.00	5.0	6.0	0.12
390.0	D	T240D397μ010μ2S	P,R	2.0	16.0	25.00	8.0	10.0	0.070	<b>50 VOLT RATING AT 85°C—33 VOLT RATING AT 125°C</b>									
470.0	D	T240D477μ010μ2S	P,R	4.0	16.0	50.00	8.0	10.0	0.065	1.2	A	T240A125μ050μ2S	M,P	0.5	2.0	6.25	3.0	4.0	1.30
560.0	D	T240D567μ010μ2S	P,R	4.0	16.0	50.00	8.0	10.0	0.060	1.5	A	T240A155μ050μ2S	M,P	0.5	2.0	6.25	3.0	4.0	1.20
<b>15 VOLT RATING AT 85°C—10 VOLT RATING AT 125°C</b>										<b>60 VOLT RATING AT 85°C—40 VOLT RATING AT 125°C</b>									
4.7	A	T240A475μ015μ2S	P,R	0.5	2.0	6.25	3.0	4.0	0.90	0.82	A	T240A824μ060μ2S	M,P	0.5	2.0	6.25	3.0	4.0	1.60
5.6	A	T240A565μ015μ2S	P,R	0.5	2.0	6.25	3.0	4.0	0.80	1.0	A	T240A105μ060μ2S	M,P	0.5	2.0	6.25	3.0	4.0	1.40
6.8	A	T240A685μ015μ2S	P,R	0.5	2.0	6.25	3.0	4.0	0.70	4.7	B	T240B475μ060μ2S	M,P	1.0	5.0	12.50	3.0	4.0	0.51
27.0	B	T240B276μ015μ2S	P,R	1.0	2.0	12.50	4.0	6.0	0.28	5.6	B	T240B565μ060μ2S	M,P	1.0	5.0	12.50	3.0	4.0	0.47
33.0	B	T240B336μ015μ2S	P,R	1.0	2.0	12.50	4.0	6.0	0.24	12.0	C	T240C126μ060μ2S	M	1.0	5.0	12.50	4.0	6.0	0.27
39.0	B	T240B396μ015μ2S	P,R	1.0	2.0	12.50	4.0	6.0	0.22	15.0	C	T240C156μ060μ2S	M	1.0	5.0	12.50	4.0	6.0	0.26
150.0	C	T240C157μ015μ2S	P,R	1.0	7.0	12.50	6.0	8.0	0.10	18.0	C	T240C186μ060μ2S	M	1.5	10.0	18.25	4.0	6.0	0.25
180.0	C	T240C187μ015μ2S	P,R	2.0	10.0	25.00	6.0	8.0	0.090	22.0	C	T240C226μ060μ2S	M	1.5	10.0	18.25	4.0	6.0	0.20
220.0	D	T240D227μ015μ2S	P,R	2.0	10.0	25.00	6.0	8.0	0.070	27.0	D	T240D276μ060μ2S	M	2.5	20.0	31.25	5.0	6.0	0.18
270.0	D	T240D277μ015μ2S	P,R	2.0	16.0	25.00	6.0	8.0	0.065	33.0	D	T240D336μ060μ2S	M	2.5	20.0	31.25	5.0	6.0	0.15
330.0	D	T240D337μ015μ2S	P,R	2.0	16.0	25.00	6.0	8.0	0.060	<b>20 VOLT RATING AT 85°C—13 VOLT RATING AT 125°C</b>									
2.7	A	T240A275μ020μ2S	P,R	0.5	2.0	6.25	3.0	4.0	1.15	2.7	A	T240A275μ020μ2S	P,R	0.5	2.0	6.25	3.0	4.0	0.95
3.3	A	T240A335μ020μ2S	P,R	0.5	2.0	6.25	3.0	4.0	0.95	3.9	A	T240A395μ020μ2S	P,R	0.5	2.0	6.25	3.0	4.0	0.90
3.9	A	T240A395μ020μ2S	P,R	0.5	2.0	6.25	3.0	4.0	0.90	18.0	B	T240B186μ020μ2S	P,R	1.0	2.0	12.50	4.0	6.0	0.27
18.0	B	T240B186μ020μ2S	P,R	1.0	2.0	12.50	4.0	6.0	0.26	22.0	B	T240B226μ020μ2S	P,R	1.0	2.0	12.50	4.0	6.0	0.26
22.0	B	T240B226μ020μ2S	P,R	1.0	2.0	12.50	4.0	6.0	0.24	27.0	B	T240B276μ020μ2S	P,R	1.0	2.0	12.50	4.0	6.0	0.24
27.0	B	T240B276μ020μ2S	P,R	1.0	2.0	12.50	4.0	6.0	0.24	56.0	C	T240C566μ020μ2S	P,R	1.0	10.0	12.50	5.0	6.0	0.15
56.0	C	T240C566μ020μ2S	P,R	1.0	10.0	12.50	5.0	6.0	0.14	68.0	C	T240C686μ020μ2S	P,R	1.0	10.0	12.50	5.0	6.0	0.14
68.0	C	T240C686μ020μ2S	P,R	1.0	10.0	12.50	5.0	6.0	0.12	82.0	C	T240C826μ020μ2S	P,R	1.0	10.0	12.50	5.0	6.0	0.12
82.0	C	T240C826μ020μ2S	P,R	1.0	10.0	12.50	5.0	6.0	0.10	100.0	C	T240C107μ020μ2S	P,R	1.0	10.0	12.50	5.0	6.0	0.10
100.0	C	T240C107μ020μ2S	P,R	1.0	10.0	12.50	5.0	6.0	0.10	120.0	C	T240C127μ020μ2S	P,R	1.0	10.0	12.50	6.0	6.0	0.090
120.0	C	T240C127μ020μ2S	P,R	1.0	10.0	12.50	6.0	6.0	0.090	150.0	D	T240D157μ020μ2S	M,P	2.0	10.0	25.00	6.0	8.0	0.080
150.0	D	T240D157μ020μ2S	M,P	2.0	10.0	25.00	6.0	8.0	0.080	180.0	D	T240D187μ020μ2S	M,P	2.0	10.0	25.00	6.0	8.0	0.070
180.0	D	T240D187μ020μ2S	M,P	2.0	10.0	25.00	6.0	8.0	0.070										

(1) To complete Part Number, insert Capacitance Tolerance Symbol in 9th character, M—±20%, K—±10%, J—±5%.  
 (2) To complete Part Number, insert Failure Rate Symbol in the 13th character as shown.

### CAPACITOR MARKINGS

#### A Case

+T240	—Polarity symbol, series designation
K10%R	—KEMET tolerance, failure rate
1R2 μF	—Capacitance*
35 V	—Voltage
215XA	—Date Code (Year and week of manufacture and batch designator)

#### B Case

+KT240B	—Polarity symbol, KEMET part number
106K035	—KEMET part number
SS10 μF	—KEMET part number (continued) capacitance
35 V 10%	—Voltage, tolerance
0216XB	—Date Code (Year and week of manufacture and batch designator)

#### C Case

+KEMET	—Polarity symbol, KEMET
T240D227K	—KEMET part number
015PS 10%	—KEMET part number (continued), tolerance
220μF 35V	—Capacitance, voltage
0220ZC	—Date Code (Year and week of manufacture and batch designator)

\*The letter "R" incorporated in the capacitance value denotes a decimal point.

## APPLICATIONS INFORMATION GR500/T240

**Introduction** — The following section is devoted to general information of assistance in the application of **T240** Series capacitors. Space does not permit a complete discussion of all technical aspects, and further information on specific problems may be obtained through KEMET sales representatives.

**Capacitance** — The nominal values listed in Table I conforms to accepted industry practice; intermediate values may be produced on special order. Standard tolerances are  $\pm 20\%$ ,  $\pm 10\%$ , and  $\pm 5\%$ . Closer tolerances may be produced upon special order and after agreement upon measurement conditions.

Typical variation of capacitance with respect to temperature is illustrated in Figure 1a. The capacitance of solid tantalum capacitors decreases with frequency, as shown in Figure 1b.

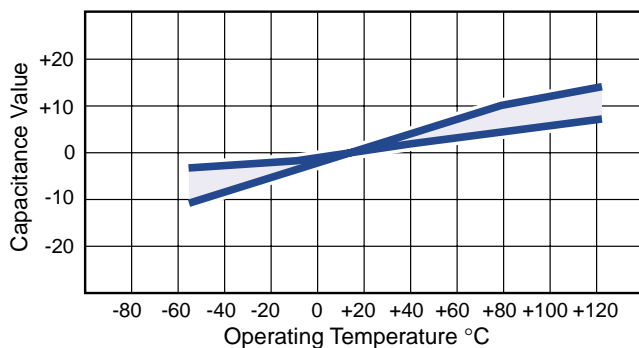

Fig. 1a Typical capacitance with temperature

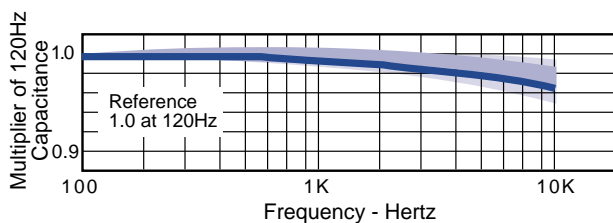

Fig. 1b Typical Variation of capacitance with frequency @ 25° C

**Dissipation Factor** — Dissipation factor is defined as the ratio of equivalent series resistance to capacitive reactance at a specified frequency:

$$D = \frac{R}{X_c} = 2\pi fCR$$

Where  $R$  = equivalent series resistance in ohms  
 $D$  = dissipation factor  
 $X_c$  = capacitive reactance in ohms  
 $C$  = series capacitance in farads  
 $f$  = frequency in Hertz

Unless otherwise stated, a standard frequency of 120 Hz is used for both dissipation and capacitance measurements. Typical behavior of dissipation factor with frequency is

shown in Figure 2. Dissipation factor loses its importance as a measurement parameter at higher frequencies, where impedance and ESR are the normal parameters of concern.

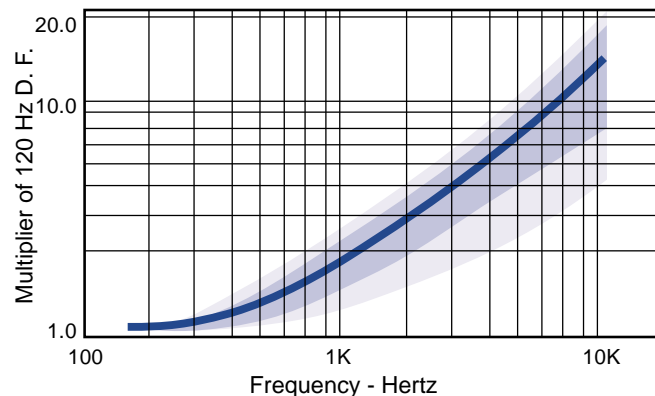

Fig. 2 Typical Behavior of dissipation factor as a function of Frequency @ 25° C

**DC Leakage Current** — The DC Leakage current limits of Table 1 for **T240** Series capacitors are the lowest generally specified in the solid tantalum industry. Even lower leakage currents are available on special order. Low leakage current, aside from its intrinsic value, is an indication of anode quality. DC leakage current as a function of temperature is represented by the typical curve in Figure 3, while similar information pertaining to leakage behavior with respect to voltage is contained in Figure 4.

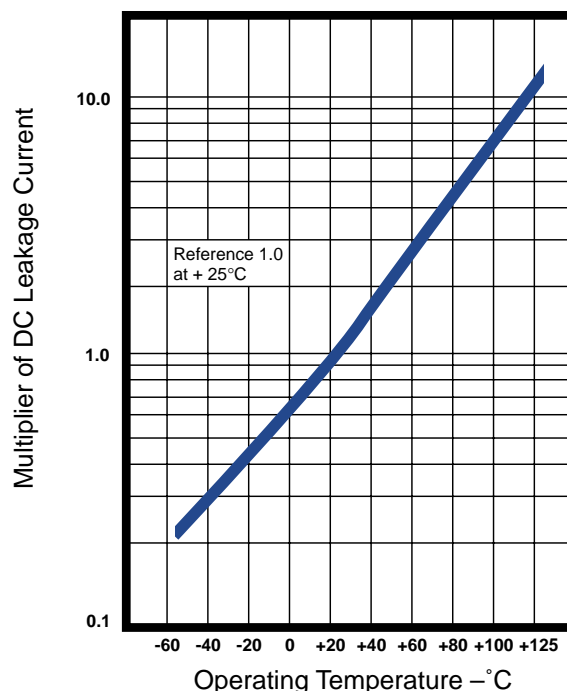

Fig. 3 Typical effect of temperature upon leakage current

APPLICATIONS INFORMATION GR500/T240 (Continued)

**Voltage and Temperature Ratings; Reliability Effect** — T240 Series capacitors are manufactured in 6 through 60 volt ratings at 85°C. Operation at 125°C with 2/3 rated voltage applied gives equivalent results, and voltage may be derated linearly between these two points. Unlike wet electrolytic capacitors, solid tantalum capacitors may be operated continuously at any voltage from zero to the maximum rating without adverse effects. Operation at voltage below nameplate improves reliability, while subsequent operation at a higher voltage will not be affected by prior low voltage use.

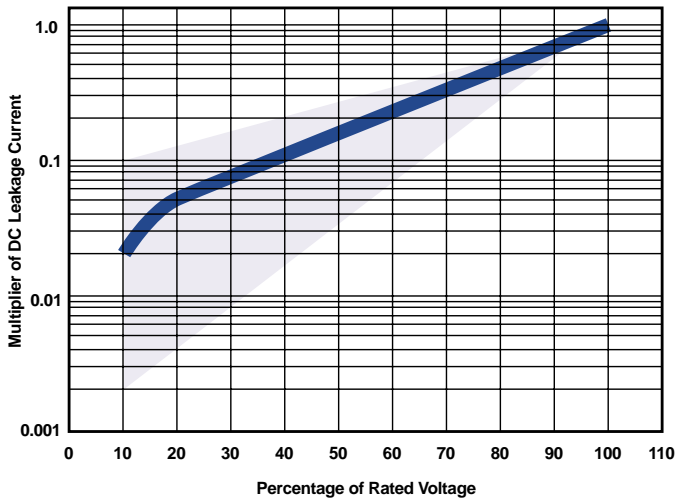

Fig. 4 Typical effect of voltage upon leakage current

Expected reliability factors for voltages and temperatures other than the rated conditions may be found in Figure 5. Since T240 Series capacitors are supplied with a predetermined failure rate under rated conditions, reliability under use conditions may be estimated with this nomograph.

**Circuit Impedance** — Failure rates are affected by temperature and voltage as described in Figure 5 and also by the circuit impedance seen by the capacitor. Traditionally, application advice for solid tantalum capacitors suggested an impedance of 3 ohms or higher per applied volt. This advice was later found to be unnecessarily conservative, and the factors in Table II, are based on 0.1 ohm per volt as the unity failure rate multiplier.

TABLE II

Circuit Impedance, Ohms per Volt	Failure Rate Multiplying Factor
0.1	1.0
0.2	0.8
0.4	0.6
0.6	0.4
0.8	0.3
1	0.2
2	0.1
≥3	0.07

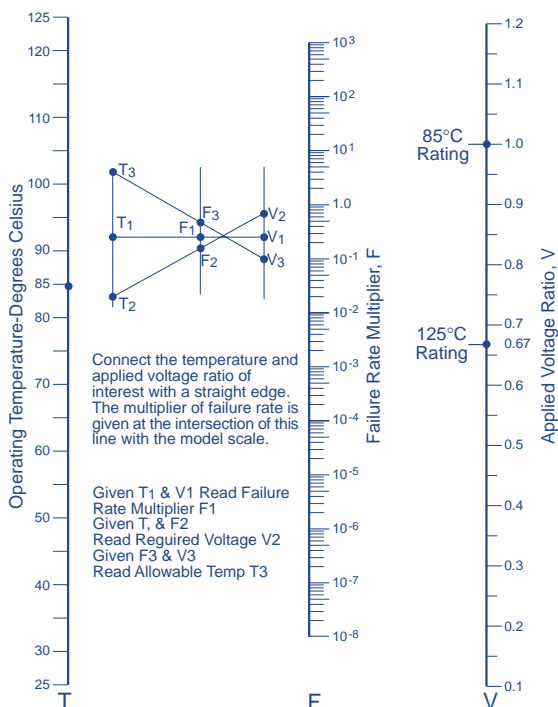

Fig.5 Reliability Alignment Chart

**Equivalent Series Resistance** — The equivalent series resistance (ESR) of a solid tantalum capacitor is frequency dependent. The curves of Figure 6 are typical of the capacitor values noted, with measurements being made by contacting lead wires 1/4 inch from the ends of the capacitor cases. Since ESR decreases with frequency, AC performance at higher frequencies is considerably better than would be predicted from the 120 Hz ratings.

**Capacitor Impedance** — The relationship between impedance and frequency at various voltage ratings is illustrated with typical curves in Figure 6. Impedance declines with decreasing capacitive reactance, but ESR becomes dominant before the self-resonant point is reached, producing the typical damped curves. Finally, impedance increases as inductance of the lead wire and other capacitor elements dominates. Obviously, high frequency impedance is directly influenced by the length of lead wire and general mounting configuration. The typical curves of Figure 6 include 1/4 inch of lead wire at each end of the capacitor.

## APPLICATIONS INFORMATION GR500/T240 (Continued)

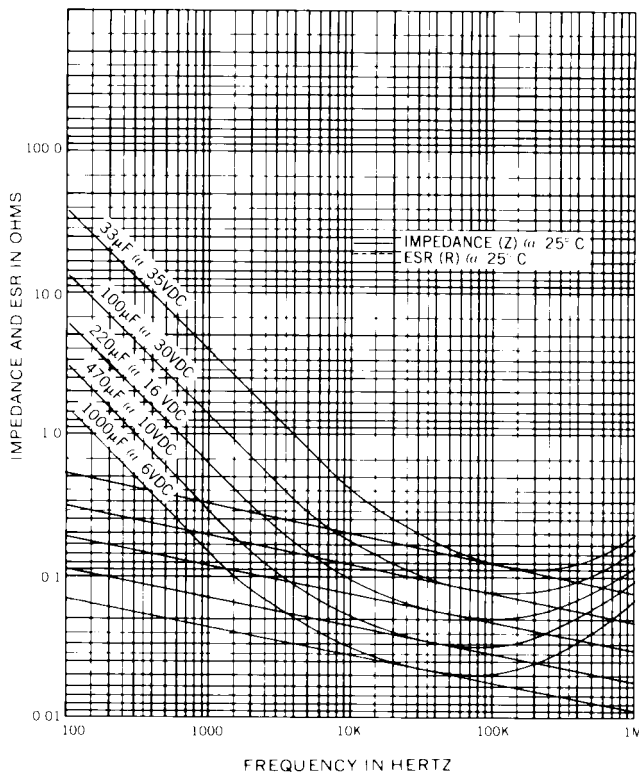

Fig. 6 Typical Behavior of Impedance and ESR as a function of frequency @ 25°C

**AC Ripple** — Permissible AC ripple voltage is related to the rated voltage, the ESR of the capacitor, and the power dissipation capability of a particular case size:

1. The positive peak AC voltage plus the DC bias voltage (if any), must not exceed the rated voltage.
2. The negative peak AC voltage, in combination with the bias voltage (if any), must not exceed that allowable (see Reverse Voltage).
3. The power dissipated in the equivalent series resistance of the capacitor must not exceed the limits specified in Table III.

The power dissipated may be calculated from the following:

$$P = \frac{E^2 R}{Z^2}$$

Where E = ripple voltage across capacitor in rms volts

Z = capacitor impedance in ohms at the specified frequency.

R = equivalent series resistance in ohms

Ripple voltage, as limited by power dissipation, may be determined as follows:

$$E_{\max}(25^\circ\text{C}) = Z \sqrt{\frac{P_{\max}}{R}}$$

Where P max = maximum permissible power from Table III

Z = Impedance

R = ESR

E max (85°C) = 0.9 E max (25°C)

E max (125°C) = 0.4 E max (25°C)

TABLE III

Maximum Permissible Power Dissipation at 25°C Ambient

Case Size	Watts
A	0.090
B	0.100
C	0.125
D	0.180

**Reverse Voltage** — The solid tantalum capacitor is a polar device and can be damaged by serious reversals of polarity even for short periods of time. However, some short duration reversal is permissible as shown in Table IV.

TABLE IV

Permissible Reverse Voltage	
Temp. °C	% of Forward Rated Voltage
25	15
85	5
125	1

**Surge Current** — Surge current testing is performed to provide resistance from damage due to circuit transients. This test, employing total DC circuit resistance of 1.0 max, exclusive of the capacitor, is described on Page 21.

**Shelf Life** — Shelf life is particularly difficult to define for the solid tantalum capacitor. Extended periods of storage at high temperature will cause some small change in leakage current which usually returns to normal upon short time application of working voltage. Storage at low temperatures causes little or no degradation of leakage current. Long-term studies of capacitance and dissipation factor shift for as long as 45,000 hours indicate only minor variations (usually less than 2%) in these parameters.

**Installation** — Mounting procedures should not place undue strain on terminals, particularly the positive end with its glass-metal seal. Attention to soldering technique should avoid excessive heat transfer which might remelt the capacitor's internal solder and cause loss of hermeticity or short circuits. Potting materials should not produce excessive curing exotherms or shrinkage pressures.

# GR500

## KEMET Graded Reliability Specification

### CAPACITORS, FIXED, SOLID TANTALUM ELECTROLYTE, HIGH RELIABILITY

**1. SCOPE**

**1.1 General Description**—This specification details requirements for high reliability, tantalum, solid electrolyte, hermetically sealed, fixed capacitors having a graded or determined failure rate. Operating temperature range is -65°C to +125°C with primary applications including filtering, bypass and coupling where the ac component of applied voltage is maintained within the limits as listed in the applicable detail specification.

Capacitors covered by this specification are intended for use where determination of failure rate, shelf life, stability, leakage current and maximum resistance to environmental factors are of major concern.

**1.2 Classification**—Part numbering of capacitors manufactured in accordance with this specification is described on Pages 4 and 11.

**2. APPLICABLE DOCUMENTS**

The following documents of the issue in effect form a part of this specification to the extent specified herein:

**2.1 Specifications—Federal**

- QQ-S-571 — Solder; Tin Alloy; Lead-Tin Alloy; and Lead Alloy
- TT-I-735 — Isopropyl Alcohol

**2.2 Specifications—Military**

- MIL-PRF-39003 — Capacitors, Fixed, Electrolytic (Solid Electrolyte) Tantalum, Established Reliability, General Specification for

**2.3 Standards—Military**

- MIL-STD-202 — Test Methods for Electronic and Electrical Components Parts.
- MIL-STD-790 — Reliability Assurance Program for Electronic Parts
- MIL-STD-810 — Environmental Test Methods
- MIL-STD-1276 — Leads, Weldable, for Electronic Component Parts

**3. REQUIREMENTS**

**3.1 Detail requirements for individual capacitor series**

The part requirements for a capacitor series shall be as specified herein and as described in the applicable detail speci-

fication. In the event of any conflict between the requirements of this specification and the detail specification, the latter shall govern.

**3.2 Reliability assurance**—Capacitors furnished under this specification shall be subject to the requirements and procedures of 4.1.2, 4.4.2 and 4.5.

**3.3 Material**—The material shall be as specified herein. However, when a specific material is not designated, a material shall be used which will enable the capacitors to meet the performance requirement of this specification. Acceptance or the approval of any constituent material shall not be construed as a guarantee of the acceptance of the finished product. Material traceability shall be maintained throughout manufacture.

**TABLE 1 — DC Rated and Surge Voltages (VDC)**

Rated Voltage 85°C	Surge Voltage 85°C	Rated Voltage 125°C	Surge Voltage 125°C
6	8	4	5
10	13	7	9
15	20	10	12
20	26	13	16
30	39	20	26
35	46	23	28
50	65	33	40
60	78	40	50
75	98	50	64
100	130	67	86

**3.3.1 Solder**—Solder shall be as described in QQ-S-571

**3.3.2 Soldering flux**—Soldering flux shall be of the rosin or rosin and alcohol type. Other non-corrosive fluxes may be used if adequate evidence indicates that no deleterious effect will be introduced.

**3.4.1 Case**—Each capacitor shall be hermetically enclosed in a case which will protect the capacitor element from deterioration in performance according to the environmental conditions specified.



## GR500 GRADED RELIABILITY SPECIFICATION

3.4.2 **Case insulation (when applicable)**—Case insulation shall not soften or creep at the high operating temperature.

3.4.3 **Terminals**—All terminal elements shall be adequately secured so that normal movements of the terminal leads will not result in degradation, damage, or excessive strain to the capacitor element, case, or coating. Wire lead terminals shall be solder coated type N32 or N34 of MIL-STD-1276. Coating solder shall have a tin content of 40-70% and shall meet the solderability requirements of 3.5.13. Other lead materials and finishes are available. Refer to the applicable detail specification.

### 3.5 Inspection Tests

3.5.1 **Thermal Shock**—Capacitors shall be subjected to thermal shock per 4.5.2.

3.5.2 **Grading (accelerated voltage aging)**—Capacitors shall be graded per 4.5.3. Available failure rates for a given series, capacitance and voltage rating shall be as listed in the applicable detail specification.

3.5.3 **DC leakage**—The dc leakage shall not exceed the initial requirements listed in the applicable detail specification when measured per 4.5.4.

3.5.4 **Capacitance**—The capacitance shall be within the specified tolerance band listed in the applicable detail specification when measured per 4.5.5.

3.5.5 **Dissipation factor**—The dissipation factor shall not exceed the initial requirements listed in the applicable detail specification when measured per 4.5.6.

3.5.6 **ESR**—The ESR shall not exceed the limits specified in the detail specification at 100 kHz, +25°C.

3.5.7 **Seal**—Capacitors shall be tested for hermeticity per 4.5.7. After test, D.C. leakage shall not exceed the initial requirements listed in the applicable detail specifications.

3.5.8 **Radiographic Inspection**—Capacitors subjected to a two plane x-ray analysis per 4.5.8 shall reveal no indication of defective connections, improperly aligned anode assemblies, defective seals or eyelets, excessive solder voids, insufficient or excessive anode bonding solder, loose particles, or other structural weaknesses.

3.5.9 **Visual and mechanical examination**—Capacitors examined per 4.6.1 shall show compliance with requirements of 3.1, 3.3, 3.4, 3.6 and 3.8.

3.5.10 **Shock**—Capacitors tested per 4.5.9 shall exhibit no electrical discontinuities greater than 500 microseconds duration. There shall be no indication of mechanical damage, arcing, or breakdown.

3.5.11 **Vibration**—Capacitors tested per 4.5.10 shall exhibit no electrical discontinuities greater than 500 microseconds duration. There shall be no indication of mechanical damage, arcing or breakdown.

3.5.12 **Thermal shock and immersion**—Capacitors tested per 4.5.12 shall meet the requirements listed in the applicable detail specification.

3.5.13 **Solderability**—Capacitors tested per 4.5.12 shall exhibit leads with a minimum of 95% of the dipped surface uniformly covered with new solder coat. Only small pin holes or rough spots, not concentrated in one area, on the remaining 5% of the dipped surface shall be considered acceptable.

3.5.14 **Terminal strength**—Capacitors tested per 4.5.13 shall exhibit no loosening effect or permanent damage to the terminals or terminal solder.

3.5.15 **Moisture resistance**—Capacitors tested per 4.5.14 shall meet the requirements listed in the applicable detail specification.

3.5.16 **Case insulation**—Capacitors tested per 4.5.15 shall meet the requirements listed in the applicable detail specification.

3.5.17 **Temperature stability**—Capacitors tested per 4.5.16 shall meet the requirements listed in the applicable detail specification.

3.5.18 **Surge current**—When tested in accordance with 4.5.17, capacitors shall meet requirements as specified in the applicable detail specifications.

3.5.19 **Life**—Capacitors tested per 4.5.18 shall exhibit no evidence of mechanical damage, permanent short circuits or opens and shall meet the requirements listed in the applicable detail specification.

3.5.20 **Solvent resistance**—Capacitors tested per 4.5.19 shall exhibit no evidence of mechanical damage or adverse effect on marking.

3.5.21 **Resistance to Soldering Heat**—Capacitors tested per 4.5.20 shall meet the requirements listed in the applicable detail specification.

3.6 **Marking**—Capacitors shall be permanently and legibly marked with the manufacturer's identification (K or KEMET), capacitance in microfarads, capacitance tolerance, rated dc voltage in volts, a plus (+) sign marked adjacent to the positive terminal and the manufacturer's lot code as specified in paragraph 3.7 and 3.7.1. See applicable detail specification for exact marking and examples.

3.7 **Lot definition**—A lot shall consist of capacitors of the same series, case size, capacitance value and voltage rating. The manufacture of all parts in the lot shall begin on the same working day. The lot identity and traceability shall be maintained throughout manufacturing, inspection, and shipping.

3.7.1 **Lot identification**—All parts in the lot shall be identified by a unique lot code consisting of a 3 or 4 digit date code denoting year and week of manufacture and a 2 letter batch code identifying a specific batch within the week.

GR500 GRADED RELIABILITY SPECIFICATION (Continued)

3.8 **Workmanship**—Capacitors shall be processed in such a manner as to be uniform in quality and shall be free from cold soldering, corrosion, pits, cracks, dents, rough edges, and other defects that will affect life, serviceability, or appearance. Solder on the surface of the case shall be smooth and unbroken and shall not have any pin holes or girdle.

3.9 **Data submittal**—Each shipment shall be accompanied by the following data for the respective lots (see paragraph 3.5.2 and 4.5.3).

- a) Weibull distribution plot
- b) Failure rate computation sheet

In addition, a statement of compliance to this specification shall accompany each shipment.

3.10 **Deviations**—Special or non-standard configurations, designs, finishes, or test requirements requiring deviation to this specification or the applicable detail specification shall be subject to negotiation between the procuring agency and the manufacturer.

4. QUALITY ASSURANCE PROVISIONS

4.1 **Responsibility for inspection**—The manufacturer is responsible for the performance of all inspection requirements as specified herein.

4.1.2 **Reliability assurance program**—The manufacturer is responsible for establishing a reliability assurance program complying with the requirements of MIL-STD-790.

4.1.3 **Additional inspection**—Nothing specified herein shall preclude the manufacturer from making additional or more stringent inspection as he may deem necessary or desirable to assure conformance with the requirements of this specification.

4.2 **Classification of testing and inspection**—The testing and inspection of capacitors shall be classified as follows:

- a) Acceptance inspection (see 4.4)

4.3 General test requirements

4.3.1 **Inspection conditions**—Unless otherwise specified, all inspection shall be made at 25°C +5°C ambient atmospheric pressure and humidity.

4.3.2 **Test equipment and inspection facilities**—Test equipment and inspection facilities shall be of sufficient accuracy and quality to permit performance of the required inspection. The manufacturer shall establish calibration of inspection equipment to the satisfaction of the user but at a minimum must meet the requirements of MIL-STD-45662.

4.4 Acceptance inspection

4.4.1 **Acceptance tests**—Acceptance tests shall consist of Group A. Capacitors shall be subjected to Group A (Subgroups 1, 2, 3), and C. Testing in accordance with Group C shall be considered degrading and product so tested shall not be shipped.

4.4.1.1 **Group A**—Group A shall consist of those tests listed in Table 2.

4.4.1.2 **Group C**—Group C shall consist of those tests listed in Table 3.

4.4.1.2.1 **Sampling Plan**—Group C shall be performed every three months. The sample shall consist of 48 pieces, selected at random from the largest and smallest case sizes produced during the month in the approximately ratio of production.

TABLE 2 — Group A Inspection

Test	Paragraph References		Number of pieces tested	Failures Allowed
	Requirement	Method		
Subgroup 1			100%	Not applicable
Thermal shock	3.5.1	4.5.2		
Surge current	3.5.1.9	4.5.18		
Grading (Accelerated voltage aging)	3.5.2	4.5.3		
DC Leakage	3.5.3	4.5.4		
Capacitance	3.5.4	4.5.5		
Dissipation Factor	3.5.5	4.5.6		
ESR	3.5.6	4.5.17		
Seal	3.5.7	4.5.7		
Radiographic inspection	3.5.8	4.5.8		
Subgroup 2				
Visual & mechanical inspection	3.5.9	4.5.1		
Subgroup 3				
Solderability	3.5.13	4.5.12	13	0
Temperature stability	3.5.17	4.5.16	20	0

Per Production Lot of a single capacitance value, case size and voltage.

TABLE 3 — Group C Inspection

Test	Paragraph References		Number of pieces tested	Failures Allowed
	Requirement	Method		
Subgroup 1			12	1
Shock	3.5.10	4.5.9		
Vibration	3.5.11	4.5.10		
Thermal shock and immersion	3.5.12	4.5.11		
Subgroup 2			12	
Terminal strength	3.5.14	4.5.13		
Resistance to solvents	3.5.20	4.5.19		
Resistance to soldering heat	3.5.21	4.5.20		
Moisture resistance	3.5.15	4.5.14		
Sleeving	3.5.16	4.5.15		
Subgroup 3				
Life (at 125°C)	3.5.19	4.5.18	24	

4.4.1.2.2 **Nonconformance**—Failures in excess of those allowed during Group C testing shall be cause to discontinue acceptance of product. Corrective action shall be instituted and the product retested. Evidence of successful corrective action shall release the product for acceptance.

4.5 Test procedures

## GR500 GRADED RELIABILITY SPECIFICATION (Continued)

4.5.1 **Visual and mechanical examination**—Examination of capacitors shall verify compliance with the requirements of materials, design, construction, physical dimensions, marking, and workmanship as listed in 3.1,3.3,3.4,3.6, and 3.8.

4.5.2 **Thermal shock (See 3.5.1)**—Capacitors shall be subjected to the thermal shock tests as specified in MIL-STD-202, Method 107. The following details shall apply:

- (a) Special mounting-Not applicable.
- (b) Test condition letter-B. (Except, # cycles = 10)
- (c) Measurements before and after test-Not applicable.

#### 4.5.3 Grading (see 3.5.2)

4.5.3.1 **Aging conditions**—Capacitors shall be power aged at 85°C for a minimum of 250 hours at a voltage greater than rated voltage (see Table 4). The aging circuit shall have less than one (1) ohms total impedance exclusive of the capacitors under test. Each capacitor shall be individually fused with a one (1) ampere fast-blow fuse.

4.5.3.1.1 **Definition of failure**—For purposes of data collection (see 4.5.3.2), a failure shall be defined as a blown fuse and shall be considered catastrophic.

4.5.3.2 **Data collection**—The elapsed time to catastrophic failures shall be recorded. The number of failures shall be recorded and calculated as a cumulative percentage of the original lot size. After data has been recorded for a minimum period of 40 hours, cumulative percentage versus failure age shall be plotted of Weibull probability paper. The Weibull scale (s) and shape (s) parameter shall then be determined (see Figures 1 and 2). The failure rate at 1 hour and the required aging time to meet the failure rate goal shall be computed. Upon completion of the required aging time, the additional data shall be plotted and failure rate confirmed.

$$Z(t) = Z(Ax) = \frac{\beta x^{\beta-1} \cdot 10^5}{\alpha A}$$

where:  $Z(t)$  = The desired instantaneous failure rate in per cent per 1000 hours at 5 equivalent hours at rated conditions.

$x$  = actual test hours.

$A$  = acceleration factor.

$\beta$  = Weibull shape parameter.

$\alpha$  = Weibull scale parameter.

The minimum test time employed will be 250 hours. however, this shall be increased, in consideration of the lot performance, to achieve the failure rate goal. Figures 1, 2, and 3 are typical examples of computation chart. Weibull plot and failure rate plot respectively.

TABLE 4 — Acceleration Factors

RATIO OF APPLIED VOLT. TO RATED VOLT. AT 85°C	ACCELERATION FACTOR
1.0000	1.0000
1.1000	6.5355
1.2000	42.7128
1.3000	279.1496
1.4000	1,824.3823
1.5000	11,923.2626
1.5276	20,000.0000

4.5.4 **DC leakage (see 3.5.3)**—Leakage current shall be measured after applying the dc rated voltage for a maximum electrification period of 5 minutes. A 1K ohm resistor shall be placed in series with the capacitor to limit the charging current. A steady source of power such as a regulated power supply shall be used. Measurement accuracy shall be within  $\pm 2$  per cent or .02 microamp, whichever is greater.

4.5.5 **Capacitance (see 3.5.4)**—Capacitance shall be measured as specified in MIL-STD-202, Method 305. The following details apply:

- a) Test frequency— 120  $\pm 5$  Hertz
- b) Limit of accuracy—  $\pm 2\%$  of reading
- c) Max. ac voltage—1.0V rms
- d) Max. dc bias—2.2V

4.5.6 **Dissipation factor (see 3.5.5)**—Dissipation factor shall be measured on a capacitance bridge or on other appropriate equipment. The following details apply:

- a) Test conditions—per 4.5.5 (details a, c, and d)
- b) Limit of accuracy—dial reading accuracy of 0.1% dissipation factor and measuring accuracy of  $\pm 2\%$  of measured value plus 0.1%.

4.5.7 **Seal Tests (see 3.5.7)**—GR500 Product receives 100% hermeticity test per MIL-STD-202, Method 112, Condition D.

4.5.8 **Radiographic inspection (see 3.5.8)**—Capacitors shall be x-rayed in two (2) planes perpendicular to their longitudinal axis. The equipment shall utilize image quality indicators (ASTM Type B) to assure that radiograms are of sufficient resolution and contrast to detect the conditions described in 3.5.8. Non-conforming devices shall be removed from the lot.

4.5.9 **Shock (see 3.5.10)**—Capacitors shall be tested as specified in MIL-STD-202, Method 213. The following details apply:

- a) Test condition letter—1 (100g peak).
- b) Mounting—Capacitor bodies shall be rigidly mounted and leads attached to well supported terminals.

GR500 GRADED RELIABILITY SPECIFICATION (Continued)

- c) Applied voltage during shock—dc rated voltage.
- d) Monitoring during shock—electrical discontinuities of 500 microseconds or greater duration.
- e) Visual examination after test—no indication of mechanical damage arcing or breakdown.

4.5.10 **Vibration (see 3.5.11)**—Capacitors shall be tested as specified in MIL-STD-202, Method 204. The following details apply:

- a) Test condition letter—D (20 g)
- b) Mounting—Capacitor bodies shall be rigidly mounted and leads attached to supported terminals. Lead length between capacitor body and supporting terminals shall be approximately 3/8 inch.
- c) Applied voltage during vibration—dc rated voltage.
- d) Monitoring during last cycle—electrical discontinuities of 500 microseconds or greater duration
- e) Visual examination after test—no indication of mechanical damage, arcing, or breakdown.

4.5.11 **Thermal shock and immersion (see 3.5.13).**

4.5.11.1 **Thermal shock**—Capacitors shall be tested as specified in MIL-STD-202, Method 107. The following details apply:

- a) Test condition letter—B (Except. # cycles = 10)
- b) Measurements before and after test—not applicable.

4.5.11.2 **Immersion**—Capacitors shall be tested as specified in MIL-STD-202, Method 104. The following details apply:

- a) Test condition letter—B
- b) Measurements after tests dc leakage, capacitance and dissipation factor (see 4.5.4, 4.5.5, 4.5.6) shall be as specified in detailed specification within 4 hours after removal from the final immersion bath.
- c) Visual examination after test

4.5.12 **Solderability (see 3.5.13)**—Capacitors shall be tested as specified in MIL-STD-202, Method 208. The following details apply:

- a) Number of leads tested-2
- b) Depth of immersion in flux and solder within 1/8 inch of case, tubulation or seal.

4.5.13 **Terminal strength (see 3.5.14)**

4.5.13.1 **Pull**—Capacitors shall be tested as specified in MIL-STD-202, Method 211. The following details apply:

- a) Test condition letter—A
- b) The body of the capacitor shall be secured.
- c) Applied force—3 pounds.

4.5.13.2 **Twist**—Capacitors shall be tested as specified in MIL-STD-202, Method 211. The following details apply:

- a) Test condition letter—D
- b) Rotations—3

4.5.14 **Moisture resistance (see 3.5.15)**—Capacitors shall be tested as specified in MIL-STD-202, Method 106 (less Step 7b). The following details apply:

- a) Applied voltage—none
- b) Measurement after test—dc leakage, capacitance and dissipation factor (see 4.5.4, 4.5.5 and 4.5.6) shall be measured within 2 to 6 hours after removal from the humidity chamber.
- c) Visual examination after test—no indication of deleterious corrosion.

4.5.15 **Case insulation (see 3.5.16)**

4.5.15.1 **Case insulation dielectric strength**—Capacitors shall be placed in a V-block. A dc potential of 2000 volts (applied at the rate of 500 volts/second) shall be applied between the V-block and capacitor case for a period 1 minute ±5 seconds. A maximum leakage current of 20 microamps will be allowed.

4.5.15.2 **Case insulation resistance**—Capacitors shall be placed in a V-block as specified in 4.5.16.1. The insulation resistance shall be measured with a polarizing voltage of 500 ±50 volts dc for 1 minute +0,-15 seconds. The capacitor shall be moved in the block and the measurement repeated five times.

4.5.16 **Temperature stability (see 3.5.17)**—DC leakage, capacitance, and dissipation factor (see 4.5.4, 4.5.5, and 4.5.6) shall be measured at the temperatures specified in Table 5, except that the dc leakage measurements at -55°C (step 2) are not required. However, after the measurements of capacitance and dissipation factor have been made at the -55°C temperature (step 2), rated voltage shall be applied for a minimum of 5 minutes. The capacitors shall be stabilized at each temperature. Thermal stability shall be considered acceptable when ΔC ≥ 0.2% between two successive measurements taken at 15 minute intervals.

TABLE 5 — Temperature Stability Test Conditions		
Step	Test Temperature (°C)	Limits
1	+25(±2)	Per tables
2	-55(+0, -3)	ΔCap ±10% DF per tables
3	+25(±2)	DC leakage, DF per tables, ΔCap ±2%
4	+85(+4, -0)	ΔCap + 8% DC leakage, DF per table
5	+125(+4, -0)	ΔCap ±12% DC leakage, DF per table
6	+25(±2)	ΔCap ±2% DC leakage, DF per table

4.5.17 **Surge Current**—Capacitors shall be subjected to 10 consecutive cycles of surge current at -55°C, +85°C. Rated voltage ±2% shall be applied for 4 ± 1 seconds, the capaci-

## GR500 GRADED RELIABILITY SPECIFICATION (Continued)

tors shall then be discharged for  $4 \pm 1$  seconds to a voltage which is less than 1% of rated voltage. Total resistance of the wiring, fixturing and power supply output, but exclusive of the capacitor under test, shall be 1.0 ohms max. After test, the capacitors shall meet the following requirements:

- DCL — Per applicable detail specification.
- Cap — Within  $\pm 2\%$  of initial measured value.
- D.F. — Per applicable detail specification.

Note: Rated Voltages  $\geq 75V$  shall be tested at max 70V.

## 4.5.18 Life (see 3.5.19)

4.5.18.1 Life—Acceptance Inspection (see Table 3)—Capacitors shall be tested as specified in 4.6.19.1. The following exceptions apply:

- a) Test condition letter-F (2,000 hours)
- b) The test temperature shall be

125°      +4°/-0°

- c) DC leakage  
(at the applicable high test temperature)  
shall be measured at 0;

250          +48/-0  
1,000        +48/-0  
2,000        +72/-0 hours

- d) Measurements after test—Per 4.5.19.1(g)

4.5.19 Resistance to solvents (see 3.5.20)—Capacitors shall be tested in accordance with MIL-STD-202, Method 215. The following details apply:

- a) Sample size shall be in accordance with Table 2 or 4 as applicable.
- b) The marked portion of the capacitor body shall be brushed.
- c) After test, capacitors shall be examined for physical or mechanical damage and deterioration or obliteration of marking.

4.5.20 Resistance to soldering heat (see 3.5.21)—Capacitors shall be tested in accordance with MIL-STD-202, Method 210. The following details apply:

- a) Test condition letter—B
- b) Depth of lead immersion in molten solder shall be within 0.250 inches of the case, tubulation, or seal.
- c) Cooling time prior to measurements after test shall be 30 minutes minimum.

d) After test, DC leakage, capacitance, and dissipation factor measurements shall be made in accordance with 4.5.4, 4.5.5, and 4.5.6.

e) Capacitors shall be examined for external physical or mechanical damage.

## 5. PREPARATION FOR DELIVERY

5.1 Leads—Capacitor leads shall be straightened prior to packaging.

5.2 Packaging methods—Capacitors shall be packaged in individual container compartments. Packaging methods and materials used shall prevent degradation of capacitor characteristics as determined by this specification.

# KEMET GRADED RELIABILITY

Figure 1

## KEMET GRADED RELIABILITY

Type T210C127K010 Lot No. 0028YK9

Nominal Capacitance 120  $\mu$ f, Rated Voltage 10 VDC

Life Test Temp 85 °C Applied Voltage 15.3 VDC

$$\frac{\text{Applied Voltage}}{\text{Rated Voltage}} = \left( \frac{15.3}{10} \right) = 1.53$$

Acceleration Factor = A = 1600

Customer _____
Purchase Order _____
Customer Part _____

### SCALE PARAMETER

Intercept of plot with principal ordinates is  $-\ln a$

$$-\ln a = (-5.1072), \quad a = [165.22]$$

### SHAPE PARAMETER

$$\text{Slope of plot} = \beta = \frac{(-4.1106) - (-5.1072)}{6.91} = [.1442]$$

### FAILURE RATE AT 1 HOUR

$$\text{Failure Rate} = Z(t) = \frac{\beta}{a} * \frac{x^{\beta-1}}{A} * 10^5 \quad (\%/K \text{ hrs})$$

$$\text{Failure Rate at 1 hr.} = Z(1) = \frac{\beta}{a} * \frac{1}{A} * 10^5 = \left( \frac{.1442}{165.22} \right) * \left( \frac{1}{1600} \right) * 10^5 = [.05456 \%/Khrs]$$

### REQUIRED TEST TIME (DESIRED FAILURE RATE .001 %/K hrs.)

Time required to achieve desired failure rate

$$= -\ln^{-1} \left[ \frac{\ln(\text{Desired Failure Rate}) - \ln(\text{Failure Rate at 1 hr.})}{\beta-1} \right]$$

$$= -\ln^{-1} \left[ \frac{\ln(.001) - \ln(.05456)}{(-.8558)} \right] = [107.0367 \text{ Hrs}]$$

### FAILURE RATE AT 250.2 HOURS (TIME TEST TERMINATED)

$$= [\text{Failure Rate at 1 hr.}] * [\text{Time test ended}]^{(\beta-1)}$$

$$= [.05456] * [250.2]^{(-.8558)} = [.000480 \%/k Hrs.]$$

Computed by Dlga Lidia Ferrera

Date Sep-29-00

Approved by [Signature]

Date Sep-29-00

GR500 GRADED RELIABILITY SPECIFICATION (Continued)

Figure 2

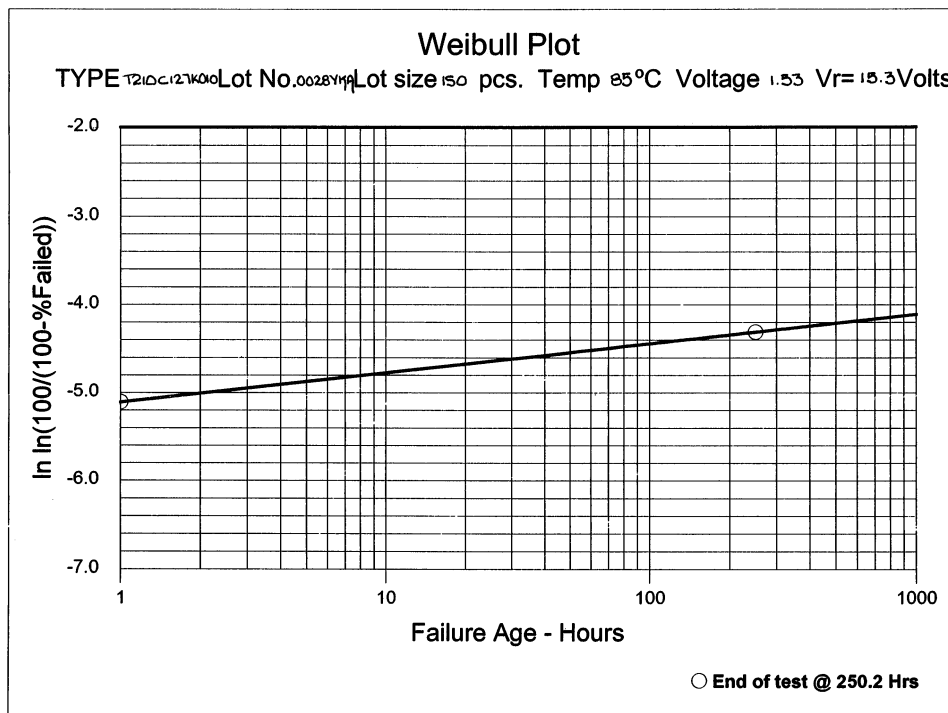
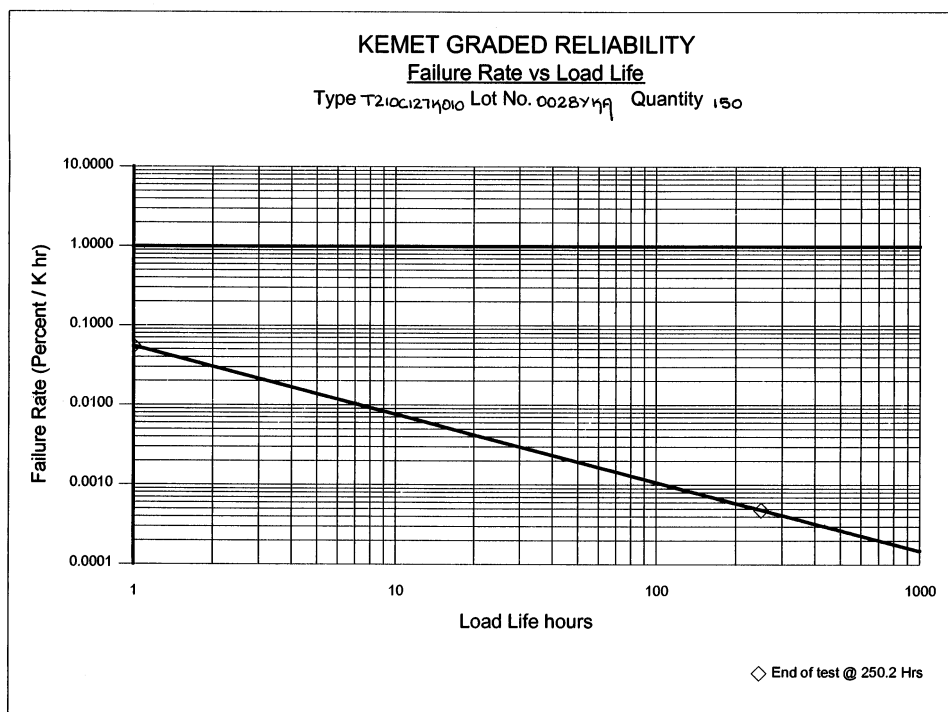

Figure 3



**World Sales Headquarters**  
**P.O. Box 5928 • Greenville, SC 29606 • www.kemet.com**  
**Phone: (864) 963-6300 • Fax: (864) 963-6521**

## **USA/Canada Locations**

KEMET Electronics Corporation  
26 Corporate Plaza, Suite 170  
Newport Beach, CA 92660  
Phone: 949-640-9320  
Fax: 949-720-9807

KEMET Electronics Corporation  
2350 Mission College Blvd., Suite 390  
Santa Clara, CA 95054  
Phone: 408-986-0424  
Fax: 408-986-1442

KEMET Electronics Corporation  
Schaumburg Corporate Center  
Suite 350, 1515 Woodfield Road  
Schaumburg, IL 60173  
Phone: 847-517-1030  
Fax: 847-517-1037

KEMET Electronics Corporation  
444 Washington Street, Suite 510  
Woburn, MA 01801  
Phone: 781-933-1010  
Fax: 781-376-0929

KEMET Electronics Corporation  
Piedmont Center East, Suite 410  
B-137, 37 Villa Road  
Greenville, SC 29615  
Phone: 864-242-5789  
Fax: 864-242-5795

KEMET Electronics Corporation  
8445 Freeport Parkway, Suite 320  
Irving, TX 75063  
Phone: 972-870-9530  
Fax: 972-870-9537

KEMET Electronics Canada Ltd.  
105-7145 West Credit Ave., Bldg. #2  
Mississauga, L5N 6J7, ON  
Canada  
Phone: 905-542-7930  
Fax: 905-542-7949

KEMET Electronics Canada Ltd.  
65 boul. Brunswick, Suite 214  
Dollard-des-Ormeaux, H9B-2N4 QC  
Canada  
Phone: 514-685-3773  
Fax: 514-685-4077

## **Europe/Africa Locations**

KEMET Electronics GmbH  
Hans-StieBberger-StraBe 2A  
D85540 Haar/Munich  
Germany  
Phone: 49-89-456-4200  
Fax: 49-89-460-4117

KEMET Electronics S.A.  
1-3, Avenue de la Paix  
P.O.B. 76  
CH-1211 Geneva 20,  
Switzerland  
Phone: 41-22-715-0100  
Fax: 41-22-715-0170

KEMET Electronics Ltd.  
Waterfront House, 55/61 South St.  
Bishop's Stortford  
Hertfordshire, CM23 3AL  
United Kingdom  
Phone: 44-1279-757343  
Fax: 44-1279-757188

Aviv Electronics Ltd.  
Hayetzira St. No. 4  
P.O. Box 2433  
Ra'anana, 43100  
Israel  
Phone: 972-9-748-3232  
Fax: 972-9-741-6510

Avnet South Africa  
P.O. Box 13004  
Belmont Office Park  
14 Belmont Road  
Rondebosch  
Mowbray, Capetown, South Africa 7705  
Phone: 27-(0)21 689 4141  
Fax: 27-(0)21 686 4709

Arrow Altech Distribution PTY LTD  
P.O. Box 701  
Isando, 1600  
South Africa  
Phone: 27-11-923-9699  
Fax: 27-11-923-9720

## **Asia Locations**

KEMET Electronics (Shanghai) Co., Ltd.  
2/F, No. 7 Bldg., 330 Xlya Rd.  
Waigaoqiao Free Trade Zone  
Pudong, Shanghai 200137, China  
Phone: 86-21-5046-0983  
Fax: 86-21-5046-0981

KEMET Electronics Asia Ltd.  
Rm 605, Citic Bldg.  
No. 19 Jian Guo Men Wai Da Jie  
Beijing, 100004, China  
Phone: 86-10-8526-3628  
Fax: 86-10-8526-3626

KEMET Electronics Asia Ltd.  
4A Chuan Hing Industrial Bldg.  
14 Wang Tai Road  
Kowloon Bay, Hong Kong  
Phone: 852-2305-1168  
Fax: 852-2759-0345

KEMET Electronics Marketing PTE Ltd.  
8-2-04, Sunny Point Kompleks, Jalan  
Batu Uban, 11700 Penang  
Penang, Malaysia  
Phone: 60-4-6595200  
Fax: 60-4-6595220

KEMET Electronics Marketing PTE Ltd.  
101 Thomson Road, #23-03  
United Square  
Singapore, 307591, Singapore  
Phone: 65-353-6636  
Fax: 65-353-6656

KEMET Electronics Corporation  
Taiwan Branch, 3-4F, No. 148, Section 4  
Chung-Hsaio E. Rd.  
Taipei, Taiwan ROC  
Phone: 886-2-27528585  
Fax: 886-2-27213129

WesTech Electronics & System Co. Ltd  
302/12 Central Condominium  
Ladproa Soil, Ladproa Road  
Ladyao, Jatujak  
Bangkok, Thailand 109000  
Phone: 662-939-3482-6  
Fax: 662-939-3491

Crusader Electronics Pty. Ltd.  
Unit 3, 92 Bryant Street  
Padstow, NSW 2211, Australia  
Phone: 612-9792-3922  
Fax: 612-9792-1446

Unicom International Corporation  
702 Shinhwa Bldg., Mapo-Gu  
Seoul, 121050, Korea  
Phone: 82-2712-5821  
Fax: 82-2712-5823