

### Features

1. High current transfer ratio ( $V_{CE0}:300V$  MIN)  
(CTR:MIN.600% at  $I_F=1mA$ ,  $V_{ce}=2V$ )
2. High isolation voltage between input and output  
(Viso:5000Vrms).
3. Compact dual-in-line package.
4. Available package : DIP/ SMD/ H. (For Package Dimension please refer to page 82 )

### Applications

1. System appliances, measuring instruments.
2. Industrial robots.
3. Copiers, automatic vending machines.
4. Signal transmission between circuits of different potentials and impedances.
5. Telephone sets.
6. Copiers, facsimiles.
7. Interface with various power supply circuits, power distribution boards.
8. Numerical control machines.

### Outside Dimension : Unit (mm)

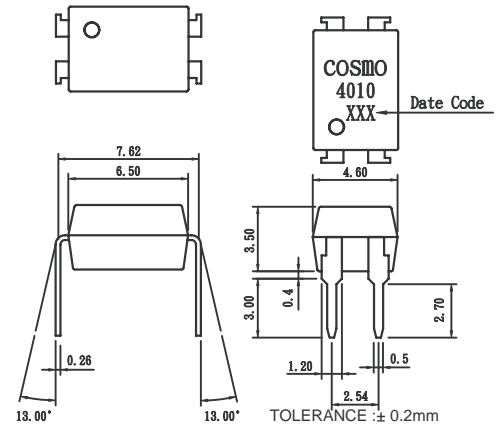

### Schematic : Top View

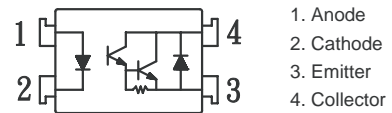

### Absolute Maximum Ratings

( $T_a=25^{\circ}C$ )

Parameter		Symbol	Rating	Unit
Input	Forward current	$I_F$	50	mA
	Peak forward current	$I_{FM}$	1	A
	Reverse voltage	$V_R$	6	V
	Power dissipation	$P_D$	70	mW
Output	Collector-emitter voltage	$V_{CE0}$	300	V
	Emitter-collector voltage	$V_{ECO}$	0.1	V
	Collector current	$I_C$	150	mA
	Collector power dissipation	$P_C$	200	mW
Total power dissipation		$P_{tot}$	200	mW
Isolation voltage 1 minute		Viso	5000	Vrms
Operating temperature		$T_{opr}$	-30 to +100	$^{\circ}C$
Storage temperature		$T_{stg}$	-55 to +125	$^{\circ}C$
Soldering temperature 10 second		$T_{sol}$	260	$^{\circ}C$

### Electro-optical Characteristics

( $T_a=25^{\circ}C$ )

Parameter		Symbol	Conditions	MIN.	TYP.	MAX.	Unit
Input	Forward voltage	$V_F$	$I_F=20mA$	—	1.2	1.4	V
	Peak forward voltage	$V_{FM}$	$I_{FM}=0.5A$	—	—	3.5	V
	Reverse current	$I_R$	$V_R=4V$	—	—	10	$\mu A$
	Terminal capacitance	$C_t$	$V=0, f=1kHz$	—	30	—	pF
Output	Collector dark current	$I_{CEO}$	$V_{CE}=200V, I_F=0$	—	—	1.0	$\mu A$
Transfer characteristics	Current transfer ratio	CTR	$I_F=1mA, V_{CE}=2V$	600	—	9000	%
	Collector-emitter saturation voltage	$V_{CE(sat)}$	$I_F=20mA, I_C=5mA$	—	—	1.5	V
	Isolation resistance	Riso	DC500V	$5 \times 10^{10}$	—	—	ohm
	Floating capacitance	$C_f$	$V=0, f=1MHz$	—	0.6	1.0	pF
	Cut-off frequency	$f_c$	$V_{CC}=5V, I_C=2mA, R_L=100ohm$	—	7	—	kHz
	Response time (Rise)	$t_r$	$V_{CE}=2V, I_C=20mA, R_L=100ohm$	—	60	300	$\mu s$
	Response time (Fall)	$t_f$		—	50	250	$\mu s$

Classification table of current transfer ratio is shown below.

Model NO.	CTR (%)
*KP4010 A	600 TO 2000
KP4010 B	1500 TO 4000
KP4010 C	3000 TO 6000
*KP4010 D	5000 TO 9000
KP4010 E	600 TO 9000

\*SPECIAL OPTION

**Fig.1** Current Transfer Ratio vs. Forward Current

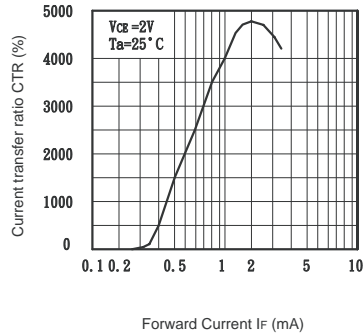

**Fig.2** Collector Power Dissipation vs. Ambient Temperature

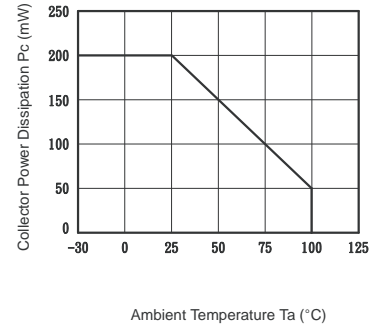

**Fig.3** Collector Dark Current vs. Ambient Temperature

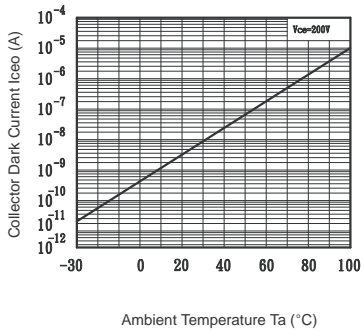

**Fig.4** Forward Current vs. Ambient Temperature

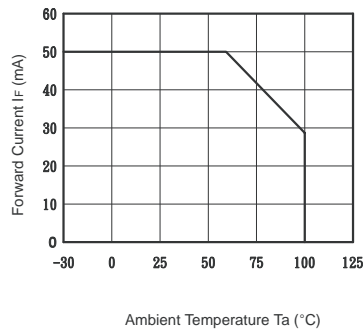

**Fig.5** Forward Current vs. Forward Voltage

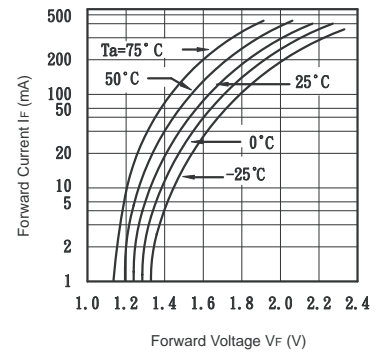

**Fig.6** Collector Current vs. Collector-emitter Voltage

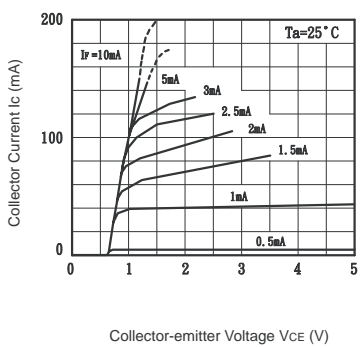

**Fig.7** Relative Current Transfer Ratio vs. Ambient Temperature

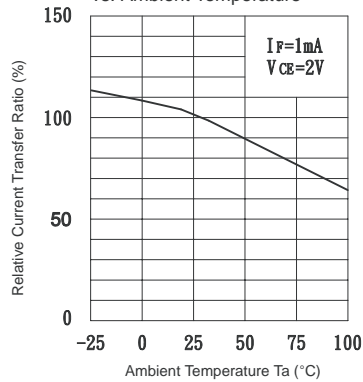

**Fig.8** Collector-emitter Saturation Voltage vs. Forward Current

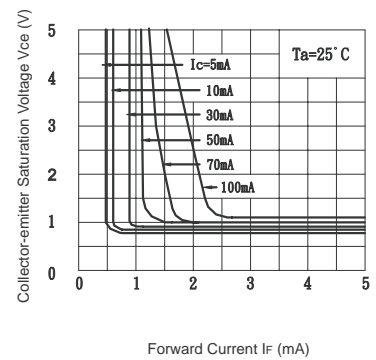

**Fig.9** Response Time vs. Load Resistance

