

■ FEATURES

- Broad Pressure Range : 50~1,000kPa.
- High Sensitivity, Excellent Linearity.
- Highly Stable in Temperature Change.

■ APPLICATIONS

- Medical Devices.
- Industrial Instrumentations.
- Pressure Switch, Water Height Control, Pneumatic Devices etc.
- Home Appliances.

■ MODEL NUMBER FOR ORDERING

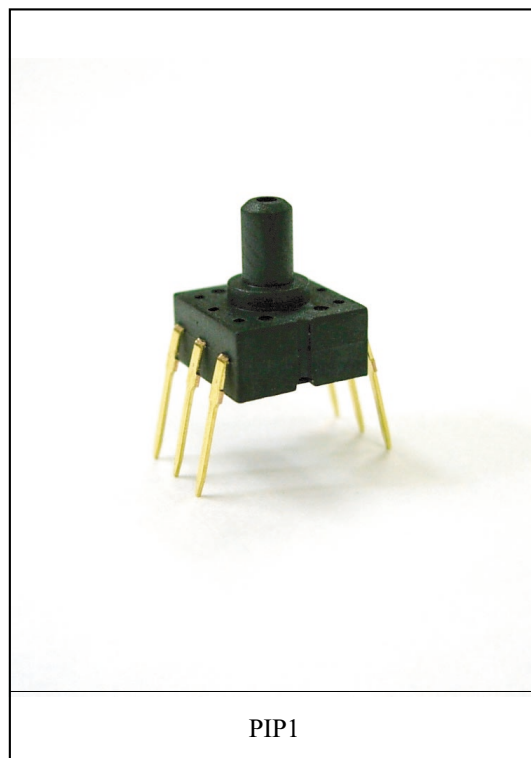
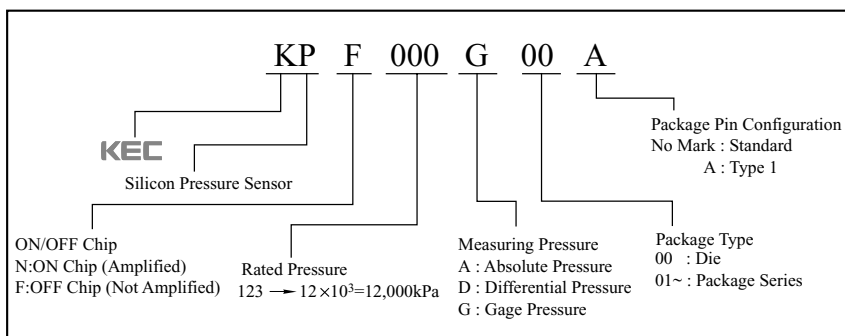

■ MAXIMUM RATING

ITEM	SPEC.							UNIT
	Model No.	KPF500G01	KPF101G01	KPF201G01	KPF401G01	KPF601G01	KPF801G01	
Classification	500	101	201	401	601	801	102	-
Rated Pressure	50	100	200	400	600	800	1000	kPa
	0.51	1.02	2.04	4.08	6.12	8.16	10.20	kgf/cm ²
Measurable Pressure Range	-50 ~ 50	-100 ~ 100	-100 ~ 200	-100 ~ 400	-100 ~ 600	-100 ~ 800	-100 ~ 1000	kPa
Maximum Pressure Load	Twice of Rated Pressure					1.5 Times of Reated Pressure		kPa(kgf/cm ²)
Bridge Impedance	3000 ~ 6000							Ω
Operating Temperature	-20 ~ 100							℃
Storage Temperature	-40 ~ 120							℃

■ ELECTRICAL CHARACTERISTICS

ITEM	SPEC.							UNIT
	Classification	500	101	201	401	601	801	
Test Condition	Operating Input Current 1.5mA constant, Ambient Temperature Ta=25 ℃							-
Compensational Temperature Range	0 ~ 50							℃
Full Scale Voltage	60 ~ 140							mV
Offset Voltage	±20							mV
Linearity	±0.3							%FS
Pressure Hysteresis	±0.5							%FS
Mechanical Response Time	2							msec
Temperature Coefficient Of Offset (TCO)	±5.0							%FS
Temperature Coefficient Of Sensitivity (TCS)	±2.5							%FS

- Comment) 1. Operating humidity 25~80%RH. (unless otherwise noted)
2. Please, consult us when you use any other pressure media except air.

KPF500G01 ~ KPF102G01

■ RELIABILITY TEST

ITEMS		TEST CONDITIONS
Life Test	High Temp. Storage	120 ℃, 1000hrs
	Low Temp. Storage	-40 ℃, 1000hrs
	Steady State Operating	25 ±5 ℃, 1 million times, Rated Pressure
	Low Temp. Operating	-20 ℃, 1 million times, Rated Pressure
	High Temp. Operating	100 ℃, 1 million times, Rated Pressure
	Temperature / Humidity Operating	40 ℃, 90%RH, 1 million times, Rated Voltage
Environment Test	Heat Resistance	260 ℃, 10 seconds
	Temp. Cycle	-40 ℃~120 ℃, 30minutes/1Cycle, 100Cycles
Mechanical Test	Vibration	Amplitude : 1.5mm, Frequency : 10~55Hz, X, Y, Z(3-directions), 2 hrs each direction
	Drop	75cm height, 2 times
	Lead Fatigue	Tensile Strength : 9.8N(1kgf), 10seconds Bending Strength : 4.9N(0.5kgf), Right/Left 90°, 1time
	Solderability	230 ℃, 5 seconds

■ CHARACTERISTIC GRAPHS

1. Full Scale Voltage Characteristics
Operating Input Current : 1.5mA, Temperature : 25 ℃

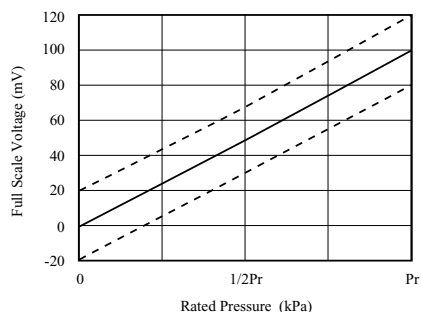

2. Temperature Coefficient of Offset (TCO)
Operating Input Current : 1.5mA, Spec. : ± 5.0 %FS

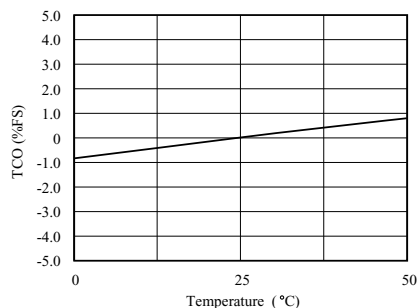

3. Temperature Coefficient of Sensitivity (TCS)
Operating Input Current : 1.5mA, Spec. : ± 2.5%FS

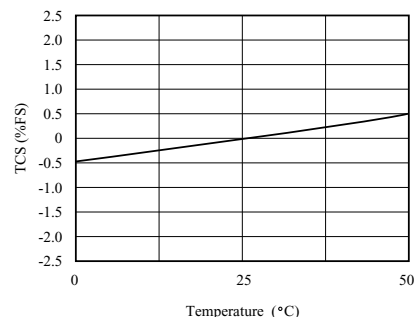

4. High Temperature continuous Operating Test
100℃, 1 million times : After testing, offset and full scale voltage variation is very small.

Offset Voltage Variation

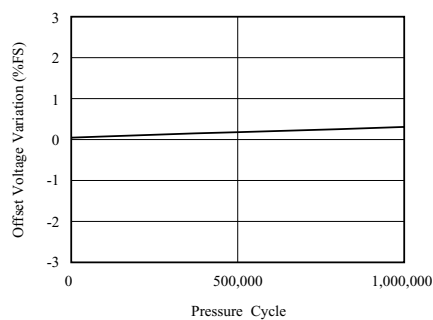

Full Scale Voltage Variation

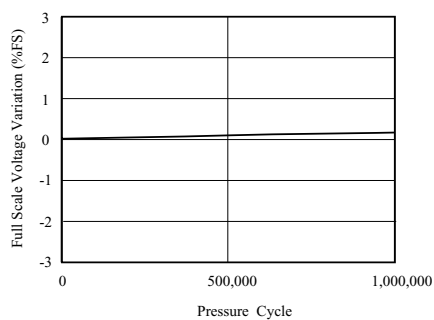

KPF500G01 ~ KPF102G01

■ PACKAGE DIMENSIONS AND PC BOARD PATTERN (Unit :mm)

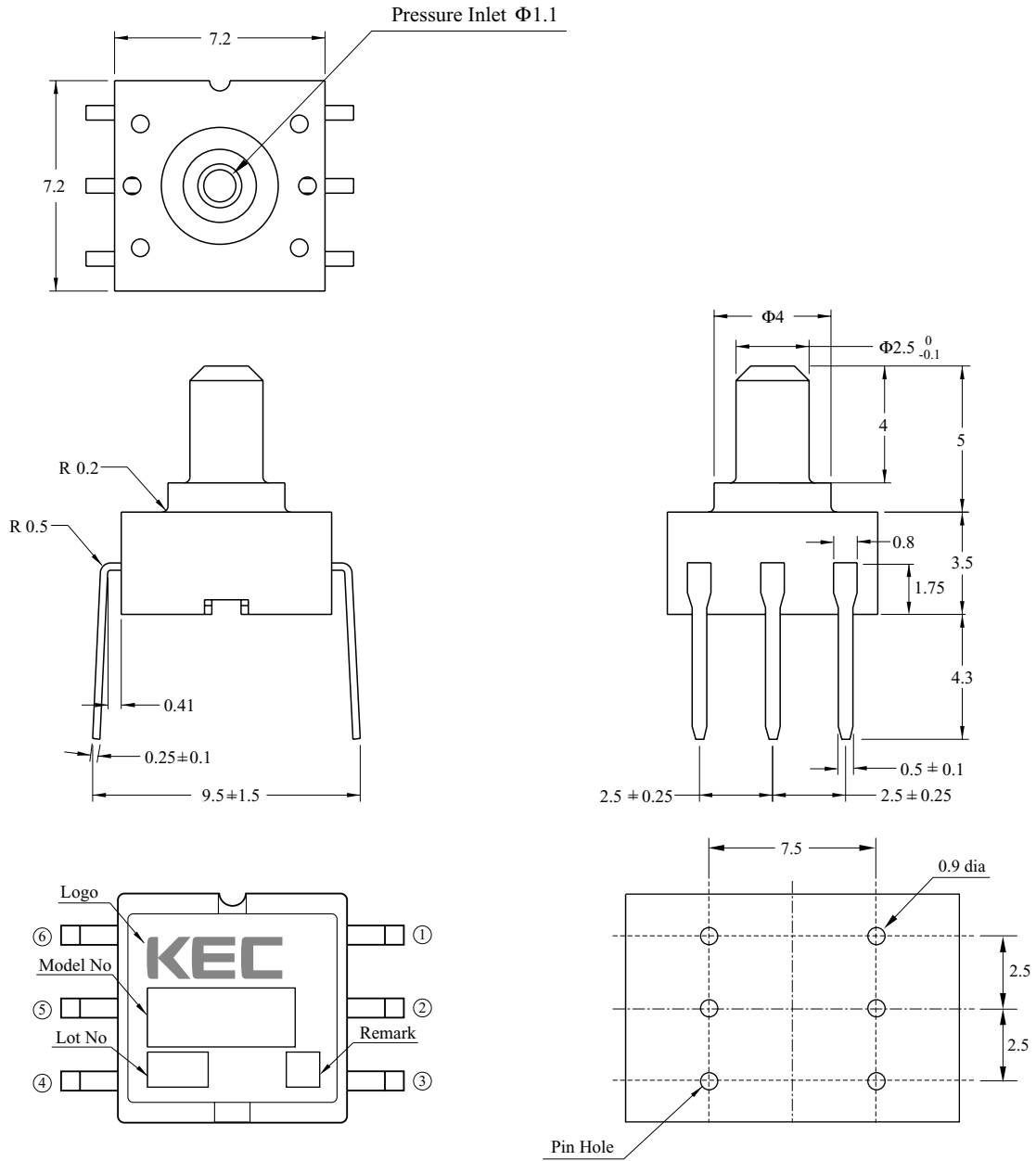

■ PIN CONFIGURATION

Terminal No.	Meaning
1	(+)Input
2	(+)Output
3	(-)Input
4	(-)Input
5	(-)Output
6	Open

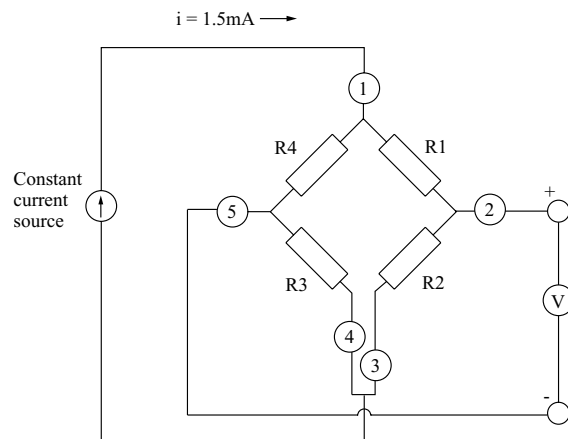

■ Note

1. Mounting on printed circuit boards

When mounting a transistor on a printed circuit, it is assumed that lead wires will be processed or reformed due to space limitation or relations with other components. Even if no such special processing reforming is conducted exercise care on the following points :

- (a) Make the spaces of lead wire inserting holes on the printed circuit board the same as those of lead wires on a transistor.
- (b) Even if The spaces are not the same, do not pull the lead wires or push heavily against the sensor element.
- (c) Use a spacer for form a lead maintain space between a sensor and a printed circuit board, rather than closely contacting them with each other.
- (d) When forming a lead prior to mounting onto a board
 - Bend the lead at a point 3mm or more apart from the body(Lead root).
 - Bend one lead wire after securing the other lead wire. (near the main body)
 - Keep space between the sensor main body and and a fixing jig.
 - When bending the lead along the jig, be careful not to damage it with an edge of the jig.
 - Follow other precautions described in respective standard
- (e) When mounting a sensor onto a heat sink
 - Use the specified accessory.
 - Drill threaded holes on the heat kink as per specifications and keep the surface free from burrs and undulations.
 - Use KEC's recommended silicon grease.
 - Tighten the screw within the specified torque.
 - Never apply a pneumatic screwdriver to a transistor main body.
- (f) Do not bend or stretch the lead wires repeatedly.

When pulling in the axial directions, apply 500g or 600g power, depending on the shapes of lead wires.

2. Soldering

When soldering a sensor to a printed circuit board, the soldering temperature is usually so high that it adversely affects the sensor. Normally, tests are conducted at a soldering temperature of 265 °C for 10 seconds or 300 °C for 3 seconds. Be sure to complete soldering procedures under these conditions of temperature and time.

Be careful to select a type of flux that will neither corrode the

lead wires nor affect the electrical characteristics of a sensor.

The basic precautions for soldering procedures are as follows :

- (a) Complete soldering procedures in a time as short as possible.
- (b) Do not apply stress to a sensor after soldering by correcting or modifying its location or direction.
- (c) For a sensor employing a heat sink, mount it on the heat sink first: then solder this unit to a printed circuit board after confirming that it is fully secured.
- (d) Do not directly solder the heat-radiating portion of a sensor to a printed circuit board.
- (e) In flow solder jobs, sensors are apt to float on the solder due to solder surface tension. When adjusting the locations of sensor, be careful not to apply excessive stress to the roots of the sensor lead wires.
- (f) When using a soldering iron select those which have less leakage, and be sure to ground the soldering iron.

3. Cleaning a circuit board

After soldering, circuit boards must be cleaned to remove flux. Observe the following precautions while cleaning them

- (a) When cleaning circuit boards to remove flux, make sure that no residual reactive ions such as Na or Cl ions remain. Note that organic solvents react with water to generate hydrogen chloride and other corrosive gases which can degrade device performance.
- (b) Do not rub the indication marks with a brush or one's fingers when cleaning or while a cleaning agent is applied to the markings.
- (c) There are ultrasonic wave cleaning methods which offer a high cleaning effect within a short time. Since there methods involve a complicated combination of factors such as the cleaning bath size, ultrasonic wave vibrator output, and printed circuit board mounting method, there is fear that the service life of airtight seal-type sensors may be extremely shortened. Therefore, as far as possible avoid using the ultrasonic wave cleaning method.
 - Basic requirements of ultrasonic wave cleaning method.
 - Frequency : 27~29kHz
 - Output : 300W or less (300W/cm² or less)
 - Recommended solvents : Refer to details above
 - Cleaning time : 30seconds or less

■ Application circuit

The Pressure sensor is designed to convert a voltage by means of constant current drive and then, if necessary, it amplifies the voltage for use. The circuit shown below is a typical example of a circuit in which the pressure sensor is used.

