

SPECIFICATIONS

MODEL	RED LAMP LED
PART NO.	LR530A

[Contents]

1.	Devices -----	2
2.	Outline Dimensions -----	2
3.	Absolute Maximum Ratings -----	3
4.	Electro-Optical Characteristics -----	4
5.	Reliability Tests -----	5
6.	Characteristic Diagrams -----	6
7.	Bin Code Description -----	8
8.	Packing -----	9
9.	Soldering Profile -----	12
10.	Reference -----	13
11.	Precaution For Use -----	14

<050201> Rev. 0.0

LR530A



SEOUL SEMICONDUCTOR CO., LTD.

148-29, Kasan-Dong, Keumchun-Gu, Seoul, Korea

TEL : 82-2-3281-6269 FAX : 82-2-857-5430

1. DEVICES

Part Number	Lens		Source	
	Color	Diffusion	Dice Source	Color
LR530A	Water Clear	Non-Diffused	AllnGaP/GaP	Red

2. OUTLINE DEMENSIONS

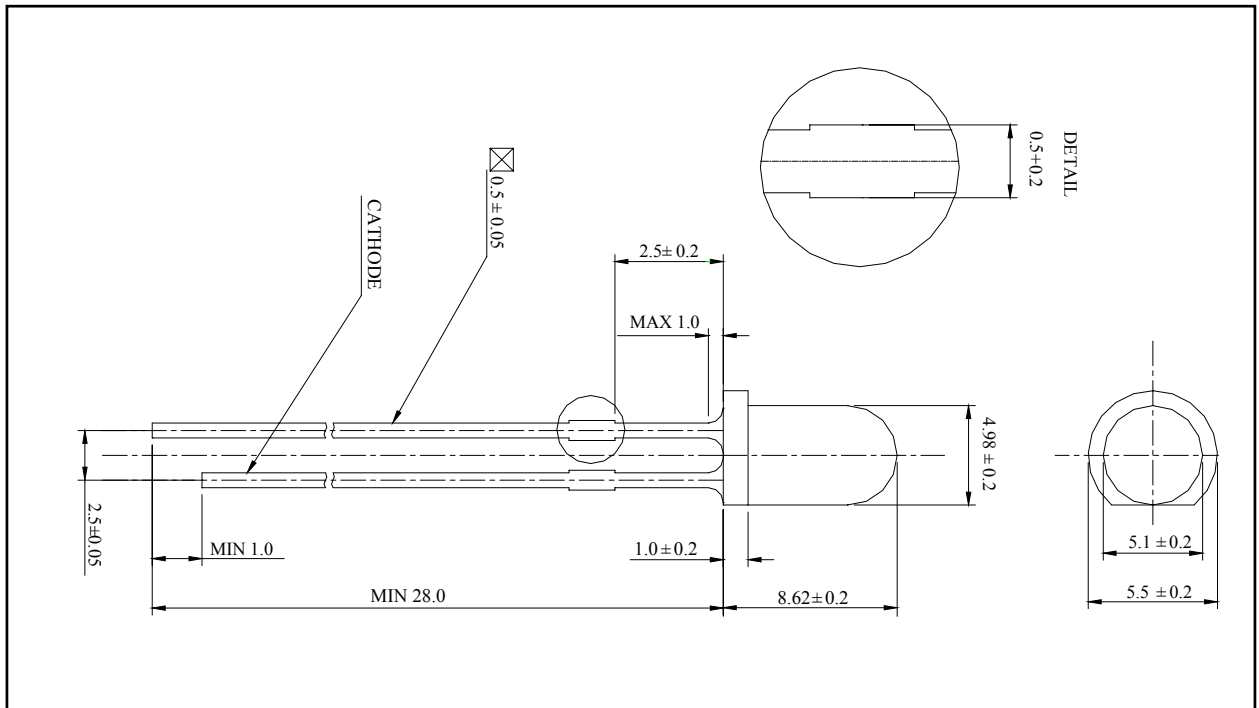

- Notes : 1. All dimensions are in millimeters.
 2. Protruded epoxy is 1.0mm maximum.

<050201> Rev. 0.0

LR530A



SEOUL SEMICONDUCTOR CO., LTD.

148-29, Kasan-Dong, Keumchun-Gu, Seoul, Korea
 TEL : 82-2-3281-6269 FAX : 82-2-857-5430

3. ABSOLUTE MAXIMUM RATINGS (at $T_a = 25^\circ\text{C}$)

Item	Symbol	Value	Unit
DC Forward Current	I_F	30	mA
Forward Peak Pulse Current	I_{FP}^1	100	mA
Reverse Voltage	V_R	5	V
Power Dissipation	P_D	90	mW
Operating Temperature	T_{opr}	-40 ~ 100	$^\circ\text{C}$
Storage Temperature	T_{stg}	-40 ~ 105	$^\circ\text{C}$
Solder Temperature	T_S	260 $^\circ\text{C}$ for 10 second ²	$^\circ\text{C}$

Notes : 1. $t \leq 0.1\text{ms}$, $D = 1/10$

2. 3mm bellow seating plane



4. ELECTRO-OPTICAL CHARACTERISTICS (at $I_F = 20\text{mA}$, $T_a = 25^\circ\text{C}$)

Item	Symbol	Value			Unit
		Min.	Typ.	Max.	
Luminous Intensity ¹	I_V	2000	3000	-	mcd
Dominant Wavelength	λ_d	622	625	630	nm
Forward Voltage	V_F	-	2.2	2.7	V
View Angle	$2\theta_{1/2}$	30			deg.
Reverse Current (at $V_R = 5\text{V}$)	I_R	-	-	10	μA

Note : 1. Luminous Intensity Tolerance $\pm 10\%$

5. RELIABILITY TESTS

Item	Condition	Note	Failures
Life Test	$T_a = RT, I_F = 30mA$	1000hrs	0/22
High Temperature Operating	$T_a = 100^{\circ}C, I_F = 10mA$	1000hrs	0/22
Low Temperature Operating	$T_a = -40^{\circ}C, I_F = 20mA$	1000hrs	0/22
Thermal Shock	$T_a = -40^{\circ}C$ (30min) ~ 105° (30min) (Transfer time : 5sec, 1Cycle = 1hr)	100cycles	0/50
Temperature Cycle	$T_a = -40^{\circ}C$ (25min) ~ $25^{\circ}C$ (5min) ~ $105^{\circ}C$ (25min) ~ $25^{\circ}C$ (5min)	100cycles	0/50
Moisture Resistance Cycle	$T_a = 25^{\circ}C \sim 65^{\circ}C \sim -10^{\circ}C, RH = 90\%$ (1Cycle = 24hrs)	10cycles	0/50
Resistance to soldering Heat	$T_s = 260 \pm 5^{\circ}C, t = 10 \pm 1sec$	1 time	0/50
ESD (Human Body Model)	1kV, 1.5k Ω ; 100pF	1 time	0/22
High Temperature Storage	$T_a = 105^{\circ}C$	1000hrs	0/50
Low Temperature Storage	$T_a = -40^{\circ}C$	1000hrs	0/50
Temperature Humidity Storage	$T_a = 85^{\circ}C, RH = 85\%$	1000hrs	0/50
Temperature Humidity Operating	$T_a = 85^{\circ}C, RH = 85\%$ $I_F = 15mA$	100hrs	0/22

< Judging Criteria For Reliability Tests >

V_F	USL ¹ X 1.2
I_R	USL X 2.0
I_V	LSL ² X 0.7

Notes : 1. USL : Upper Standard Level

2. LSL : Lower Standard Level.

<050201> Rev. 0.0

LR530A



SEOUL SEMICONDUCTOR CO., LTD.

148-29, Kasan-Dong, Keumchun-Gu, Seoul, Korea

TEL : 82-2-3281-6269 FAX : 82-2-857-5430

6. CHARACTERISTIC DIAGRAMS

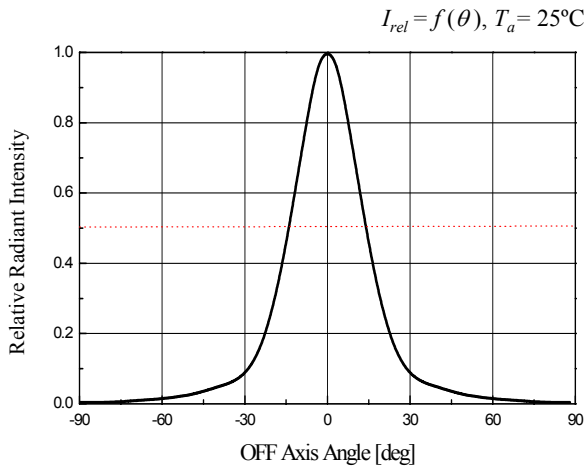

Off Axis Angle vs. Relative Intensity

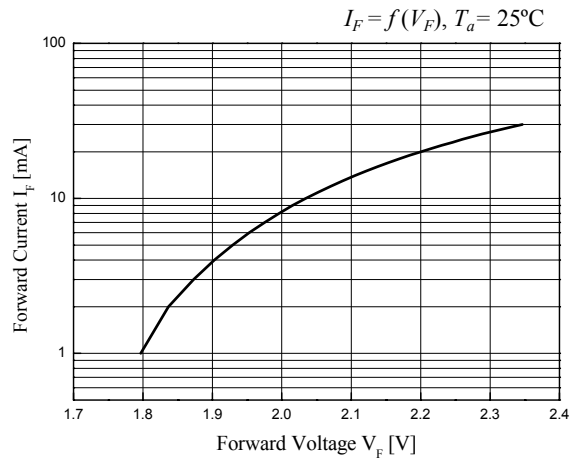

Forward Voltage vs. Forward Current

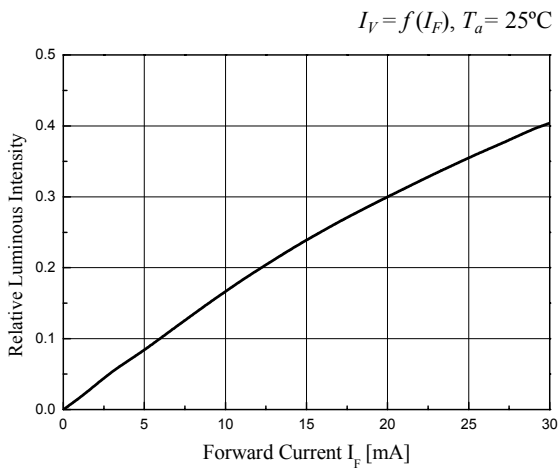

Forward Current vs. Relative Intensity

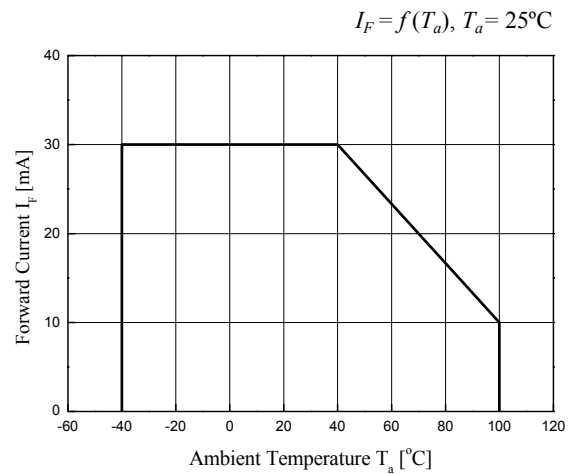

Ambient Temperature vs. Forward Current

<050201> Rev. 0.0

LR530A



SEOUL SEMICONDUCTOR CO., LTD.

148-29, Kasan-Dong, Keumchun-Gu, Seoul, Korea

TEL : 82-2-3281-6269 FAX : 82-2-857-5430

$$I_{rel} = f(\lambda_d), T_A = 25^\circ\text{C}, I_F = 20\text{mA}$$

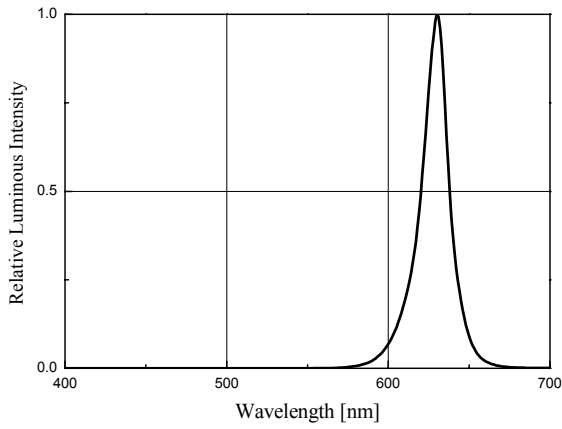

Wavelength vs. Relative Intensity

$$I_V/I_{V(25^\circ\text{C})} = f(T_A), I_F = 20\text{mA}$$

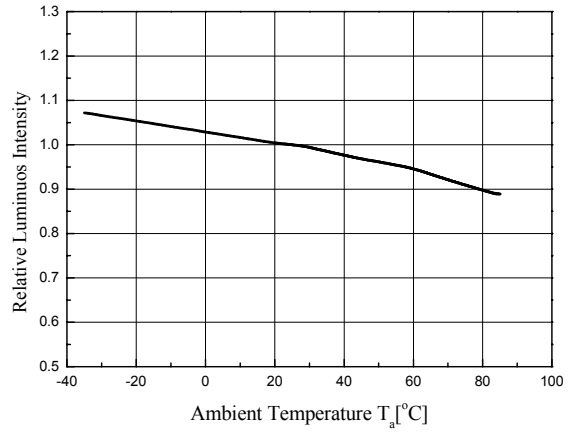

Ambient Temperature vs. Relative Intensity

<050201> Rev. 0.0

LR530A



SEOUL SEMICONDUCTOR CO., LTD.

148-29, Kasan-Dong, Keumchun-Gu, Seoul, Korea

TEL : 82-2-3281-6269 FAX : 82-2-857-5430

7. BIN CODE DESCRIPTION

BIN CODE		
Intensity	Color Ranks	Forward Voltage
A	1	1

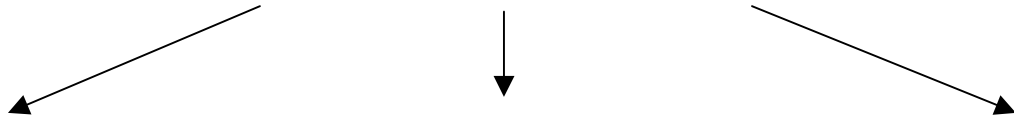

Intensity (mcd) @ $I_F = 20\text{mA}$			Dominant Wavelength (nm) @ $I_F = 20\text{mA}$			Forward Voltage (V) @ $I_F = 20\text{mA}$		
BIN CODE	Min.	Max.	BIN CODE	Min.	Max.	BIN CODE	Min.	Max.
A	2000	3000	1	622	624	1	2.0	2.2
C	3000	4000	2	624	630	2	2.2	2.4

8. PACKING

1) Bulk Packing

(1) Antistatic poly vinyl bag apply

Poly bag:

5φ Lamp Series : 500pcs

3φ Lamp Series : 500pcs

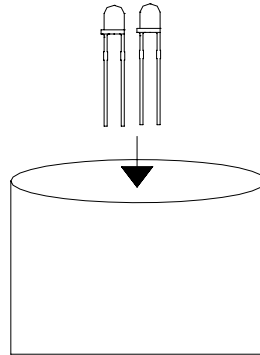

(2) Inner box structure

Box : 2 poly bags

		P/O No.	
Lot No.			
SEOUL SEMICONDUCTOR CO.,LTD TEL : (02) 3281-6269			

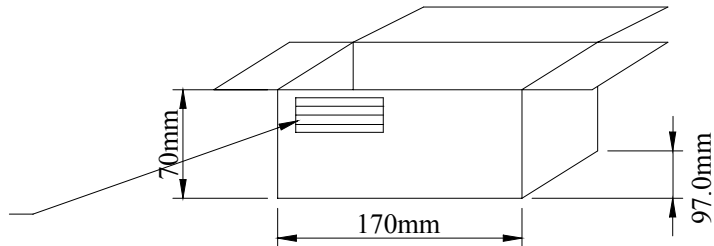

(3) Outer box structure

Box : 27 boxes

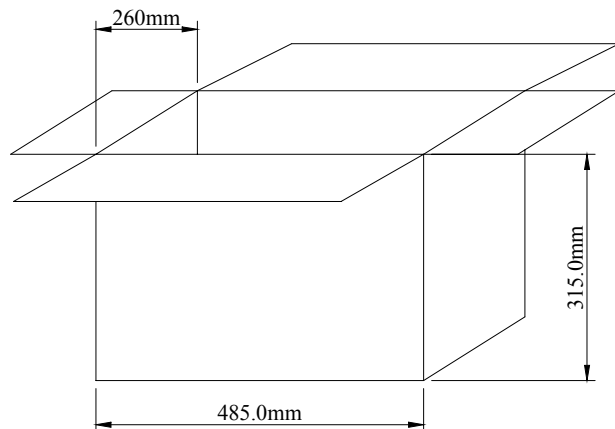

<050201> Rev. 0.0

LR530A



SEOUL SEMICONDUCTOR CO., LTD.

148-29, Kasan-Dong, Keumchun-Gu, Seoul, Korea

TEL : 82-2-3281-6269 FAX : 82-2-857-5430

2) Tapping Outline Dimensions

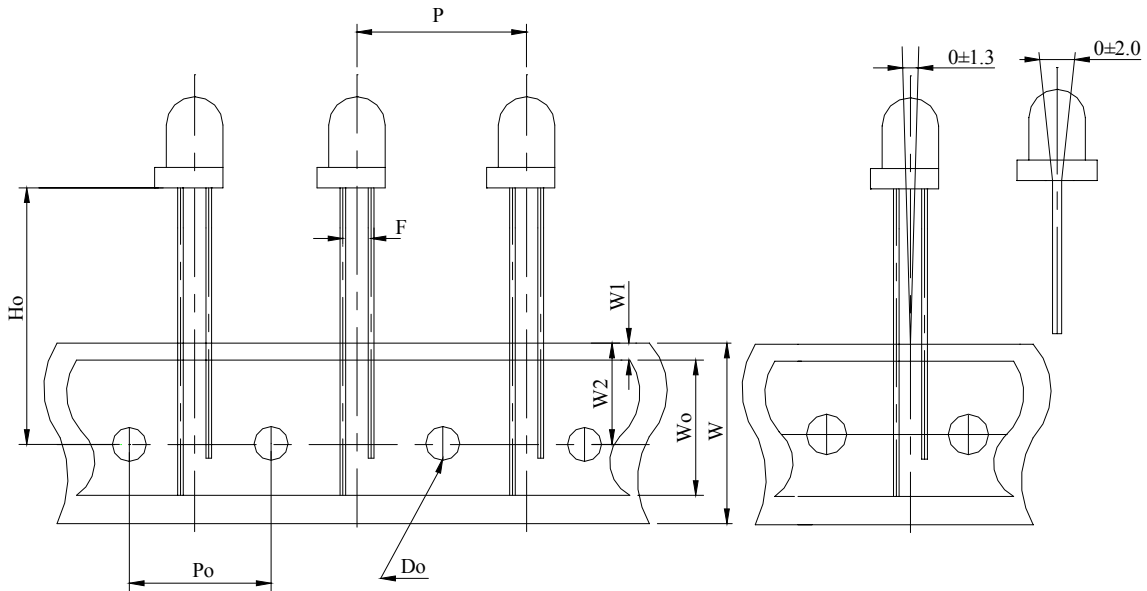

Package Dimensions (unit : mm)			
H_o^*		P	12.7 ± 0.5
W	$18.0^{+1.0}_{-0.5}$	P_o	12.7 ± 0.3
W_o	13.0 ± 0.3	F	2.54 ± 0.5
W_1	1.0 ± 0.5	D_o	$\phi 4.0 \pm 0.5$
W_2	9.0 ± 0.5		

* Remark : H_o - users define.

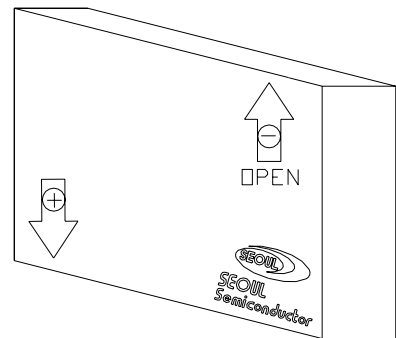

1 Box contain quantity.

* 3 ϕ Series : 3000pcs

* 5 ϕ Series : 2000pcs

<050201> Rev. 0.0

LR530A



SEOUL SEMICONDUCTOR CO., LTD.

148-29, Kasan-Dong, Keumchun-Gu, Seoul, Korea

TEL : 82-2-3281-6269 FAX : 82-2-857-5430

3) Forming Outline Dimensions

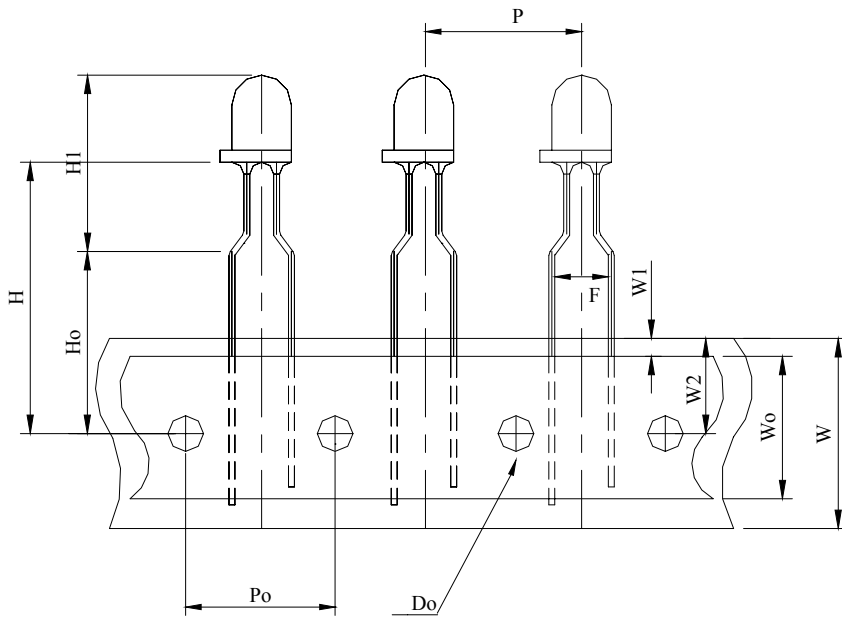

Package Dimensions (unit : mm)			
H *		W2	9.0±0.5
Ho *		P	12.7±0.5
H1 *		Po	12.7±0.3
W	18.0 ^{+1.0} _{-0.5}	F	5.0±0.5
W0	13.0±0.3	Do	φ4.0±0.5
W1	1.0±0.5		

* Remark : H / Ho / H1- users define.

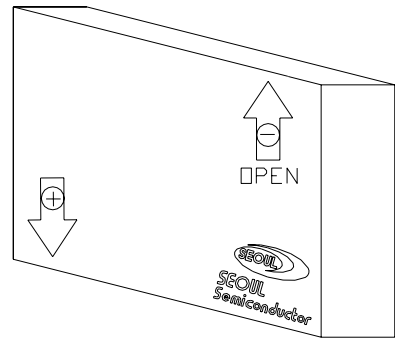

1 Box contain quantity.

* 3φ Series : 2000pcs

* 5φ Series : 1500pcs

9. SOLDERING PROFILE

1) Wave Soldering Conditions / Profile

- Preliminary heating to be at 85°C(120 °C max) for 20 seconds(60 seconds max).
- Soldering heat to be at 235 °C (260°C max) for 5 seconds (10 seconds max.)
- Soak time above 200 °C is 5 seconds

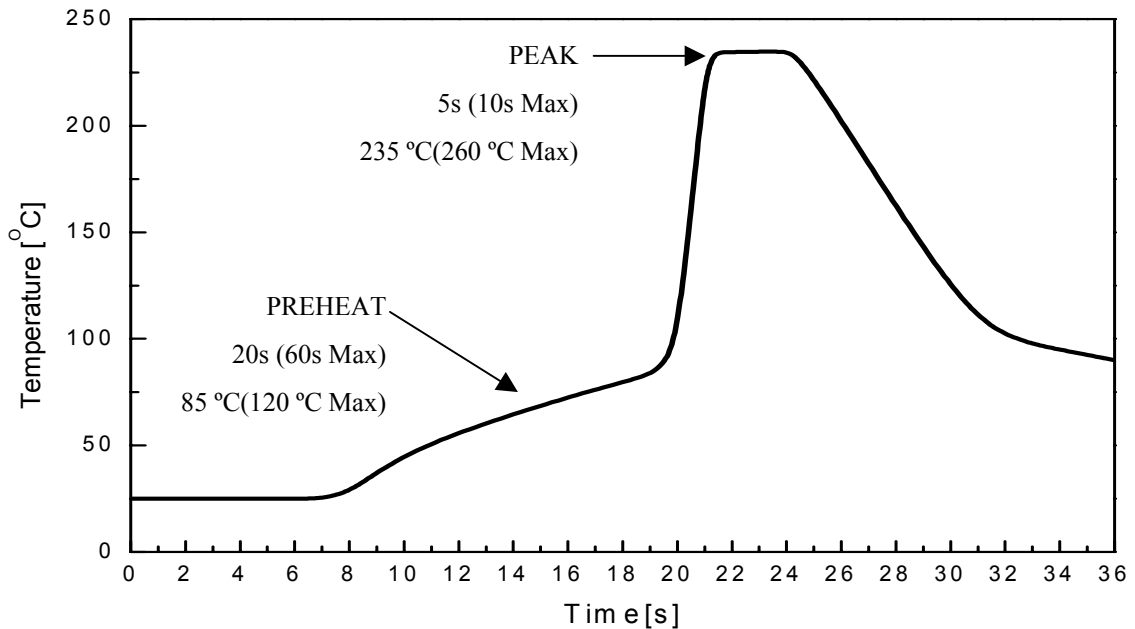

2) Hand Soldering conditions

- Not more than 5 seconds at max. 300°C, under Soldering iron.

Note : In case the soldered products are reused in soldering process, we don't guarantee the products.

10. PART NUMBERING SYSTEM

1	2	3	4	5	6	7	8		A	B	C
L	*	*	*	*	*	*	*	-	*	*	*

1) Lamp LED initial

2) Color

U : Ultra Violet, B : Blue (460~490), C : Cyan (490~510),

T : True Green (510~540), G : Yellow-Green (540~580)

Y : Yellow (580~600) O : Orange (600~620) R : Red (620~700)

W : White M : Warm I : Infrared

3) If the products have 2 or 3chips

GR : Green + Red (according to wavelength), FL : Full color

4) Outline type

1 : 3x2(square), 2 : 5x2(square), 3 : Phi3, 5 : Phi 5 ,

6 : 3Phi Oval, 7 : 5Phi Oval

5) Half angle

1: ~14°, 2: 15~24°, 3: 25~34°, 4: 35~44°, 5 : 45~54°... 0 : more than 100°

6) 1st Development according to a chip

7) 2nd Development (other material)

D : diffused C : colored Z : zener chip attached

8) Stand off type

A, B, C : Bin cord description A: IV, B: WD C: VF

11. PRECAUTION FOR USE

- 1) In order to avoid the absorption of moisture, it is recommended to store in the dry box (or desiccators) with a desiccant .
- 2) In case of more than 1 week passed after opening or change color of indicator on desiccant components shall be dried 10-12Hr, at $60\pm 5^{\circ}\text{C}$.
- 3) In case of supposed the components is humid, shall be dried dip-solder just before, 12Hr at $80\pm 5^{\circ}\text{C}$ or 10Hr at $100\pm 5^{\circ}\text{C}$.
- 4) Any mechanical force or any excess vibration shall not be accepted to apply during cooling process to normal temp. after soldering.
- 5) Quick cooling shall not be avoid.
- 6) Components shall not be mounted on warped direction of PCB.
- 7) Anti radioactive ray design is not considered for the products listed here in.
- 8) This device should not be used in any type of fluid such as water, oil, organic solvent and etc. When washing is required, IPA should be used.
- 9) When the LEDs are illuminating, operating current should be decided after considering the ambient maximum temperature.
- 10) LEDs must be stored to maintain a clean atmosphere. If the LEDs are stored for 3 months or more after being shipped from SSC, a sealed container with a nitrogen atmosphere should be used for storage.
- 11) The LEDs must be soldered within seven days after opening the moisture-proof packing.
- 12) Repack unused products with anti-moisture packing, fold to close any opening and then store in a dry place.
- 13) The appearance and specifications of the product may be modified for improvement without notice.

