

Product Description

The PE83513 is a high-performance static UltraCMOS™ prescaler with a fixed divide ratio of 8. Its operating frequency range is DC to 1500 MHz. The PE83513 operates on a nominal 3 V supply and draws only 14 mA. It is packaged in a small 8-lead plastic MSOP and is ideal for frequency scaling and clock generation solutions.

The PE83513 is manufactured on Peregrine's UltraCMOS™ process, a patented variation of silicon-on-insulator (SOI) technology on a sapphire substrate, offering the performance of GaAs with the economy and integration of conventional CMOS.

**DC - 1500 MHz Low Power UltraCMOS™
Divide-by-8 Prescaler
Military Operating Temperature Range**

Features

- DC to 1500 MHz operation
- Fixed divide ratio of 8
- Low-power operation: 14 mA typical @ 3.0 V
- Ultra small package: 8-lead MSOP

Figure 1. Functional Schematic Diagram

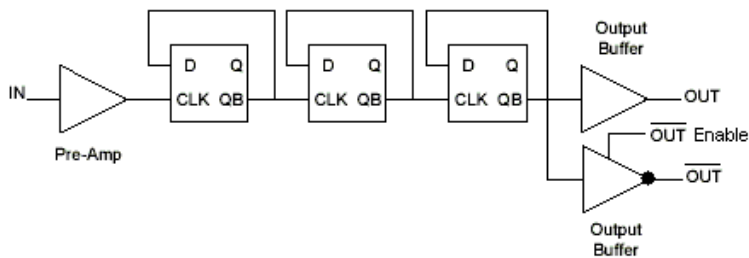

Figure 2. Package Type

8-lead MSOP



Table 1. Electrical Specifications ($Z_S = Z_L = 50 \Omega$)

$2.85 \text{ V} \leq V_{DD} \leq 3.15 \text{ V}$; $-55^\circ \text{ C} \leq T_A \leq 125^\circ \text{ C}$, unless otherwise specified

Parameter	Conditions	Minimum	Typical	Maximum	Units
Supply Voltage		2.85	3.0	3.15	V
Supply Current	OUTB Disabled		7	12	mA
	OUTB Enabled		14	25	mA
Input Frequency (F_{IN})		DC		1500	MHz
Input Power (P_{IN})	$100 \text{ MHz} \leq F_{in} \leq 1200 \text{ MHz}$ $-55^\circ \text{ C} \leq T_A \leq 85^\circ \text{ C}$	-5		+10	dBm
	$100 \text{ MHz} \leq F_{in} \leq 1200 \text{ MHz}$ $85^\circ \text{ C} \geq T_A \geq 125^\circ \text{ C}$	0		+10	dBm
	$1200 \text{ MHz} < F_{in} \leq 1500 \text{ MHz}$ $-55^\circ \text{ C} \leq T_A \leq 85^\circ \text{ C}$	+5		+10	dBm
Output Power	$\text{DC} < F_{in} \leq 1500 \text{ MHz}$	+2			dBm

Figure 3. Pin Configuration (Top View)

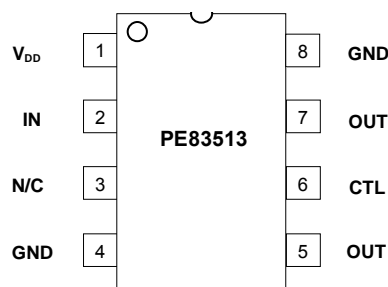

Table 2. Pin Descriptions

Pin No.	Pin Name	Description
1	V _{DD}	Power supply pin. Bypassing is required (eg 1000 pF & 100 pF).
2	IN	Input signal pin. Should be coupled with a capacitor (eg 1000 pF).
3	N/C	No connection. This pin should be left open.
4	GND	Ground pin. Ground pattern on the board should be as wide as possible to reduce ground impedance.
5	OUTB	Inverted divided frequency output. This pin should be coupled with a capacitor (eg 1000 pF).
6	CTL	Control pin. When grounded OUTB is enabled.
7	OUT	Divided frequency output. This pin should be coupled with a capacitor (eg 1000 pF).
8	GND	Ground Pin.

Table 3. Absolute Maximum Ratings

Symbol	Parameter/Conditions	Min	Max	Units
V _{DD}	Supply voltage		4.0	V
P _{in}	Input Power		15	dBm
V _{IN}	Voltage on input	-0.3	V _{DD} +0.3	V
T _{ST}	Storage temperature range	-65	150	°C
T _{OP}	Operating temperature range	-55	125	°C
V _{ESD}	ESD voltage (Human Body Model, MIL-STD 883)		2000	V

Absolute Maximum Ratings are those values listed in the above table. Exceeding these values may cause permanent device damage. Exposure to absolute maximum ratings for extended periods may affect device reliability.

Electrostatic Discharge (ESD) Precautions

When handling this UltraCMOS™ device, observe the same precautions that you would use with other ESD-sensitive devices. Although this device contains circuitry to protect it from damage due to ESD, precautions should be taken to avoid exceeding the rating specified in Table 3.

Latch-Up Avoidance

Unlike conventional CMOS devices, UltraCMOS™ devices are immune to latch-up.

Device Functional Considerations

The PE83513 divides an input signal, up to a frequency of 1500 MHz, by a factor of eight thereby producing an output frequency at one fourth the input frequency. To work properly at higher frequency, the input and output signals (pins 2, 7 & optional 5) must be AC coupled via an external capacitor. The input may be DC coupled for low frequency operation with care taken to remain within the specified DC input range for the device.

The ground pattern on the board should be made as wide as possible to minimize ground impedance. See Figure 8 for a layout example.

OUTB Control

Pin 6 controls whether OUTB is enabled or disabled. Pin 6 has an internal pull-up resistor. With no connection (floating), OUTB is disabled. By grounding pin 6, OUTB is enabled. By enabling OUTB, this part will use roughly 5 mA more current.

Typical Performance Data: $V_{DD} = 3.0\text{ V}$

Figure 4. Input Sensitivity

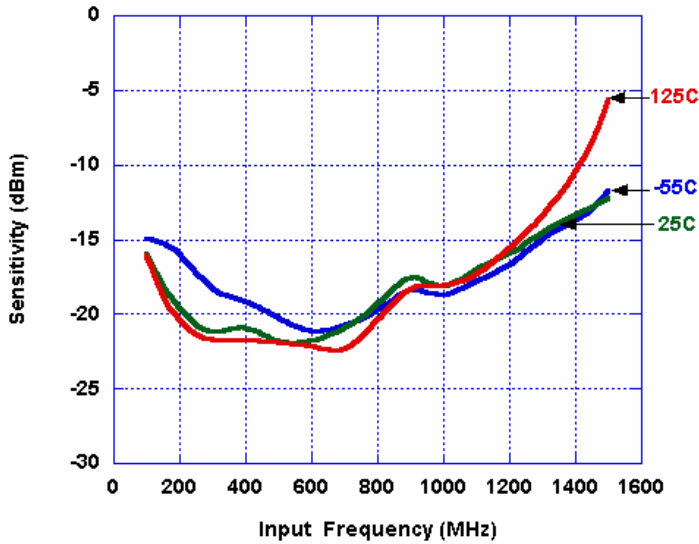

Figure 5. Device Current (OUTB Enabled)

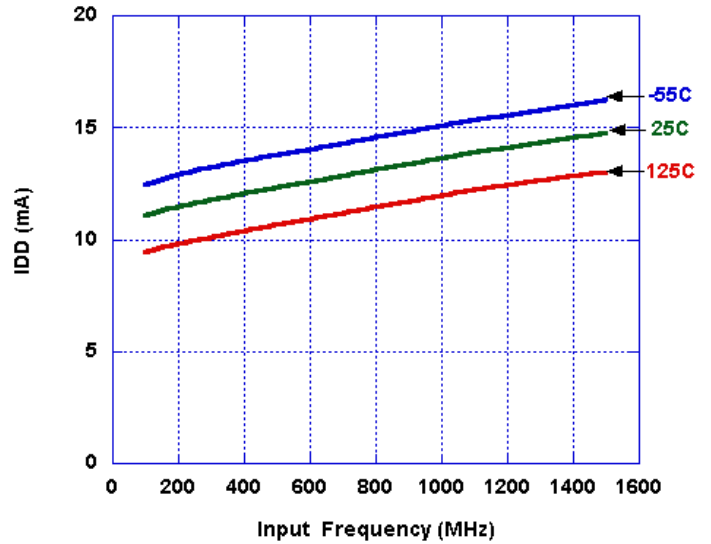
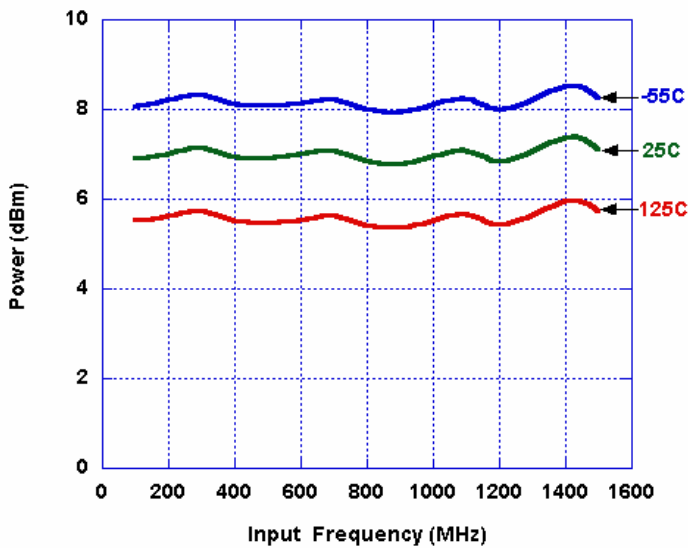

Figure 6. Output Power (OUT or OUTB)



Evaluation Kit

Evaluation Kit Operation

The PE83513 EK board was designed to ease customer evaluation of Peregrine's high performance divide-by-8 Military Grade Prescaler. On this board, the device input (pin 2) is connected via J1 and a 50Ω transmission line. A series capacitor (C3) provides the necessary DC block for the device input. It is important to note that the value of this capacitance will impact the performance of the device. A value of 1000pF was found to be optimal for this board layout; other applications may require a different value.

The device output (pin 7) is connected to connector J3 through a 50Ω transmission line. A series capacitor (C1) provides the necessary DC block for the device output. Note that this capacitor must be chosen to have low impedance at the desired output frequency the device. The value of 1000pF was chosen to provide a wide operating range for the evaluation board.

The board is constructed of a two-layer FR4 material with a total thickness of 0.031". The bottom layer provides ground for the RF transmission lines. The transmission lines were designed using a coplanar waveguide above ground plane model with trace width of 0.030", trace gaps of 0.007", dielectric thickness of 0.028", metal thickness of 0.0014" and ϵ_r of 4.4. Note that the predominate mode for these transmission lines is coplanar waveguide.

J2 provides DC power to the device. Starting from the lower left pin, the second pin to the right (J2-3) is connected to the device VDD pin (1). Two decoupling capacitors (10 pF, 1000 pF) are included on this trace. It is the responsibility of the customer to determine proper supply decoupling for their design application.

Applications Support

If you have a problem with your evaluation kit or if you have applications questions call (858) 731-9400 and ask for applications support. You may also contact us by fax or e-mail:

Fax: (858) 731-9499

E-Mail: help@psemi.com

Figure 7. Evaluation Board Layouts

Peregrine Specification 101/0190

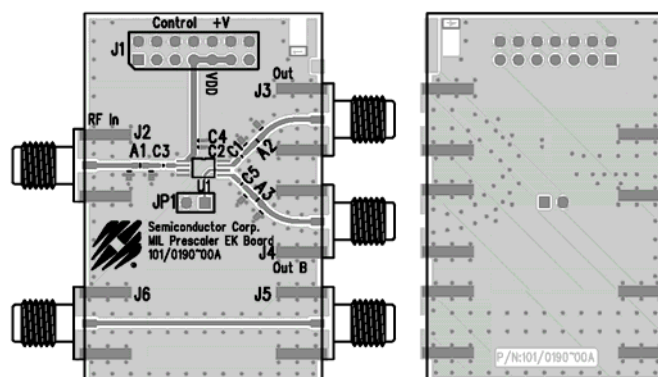

Figure 8. Evaluation Board Schematic

Peregrine Specification 102/0201

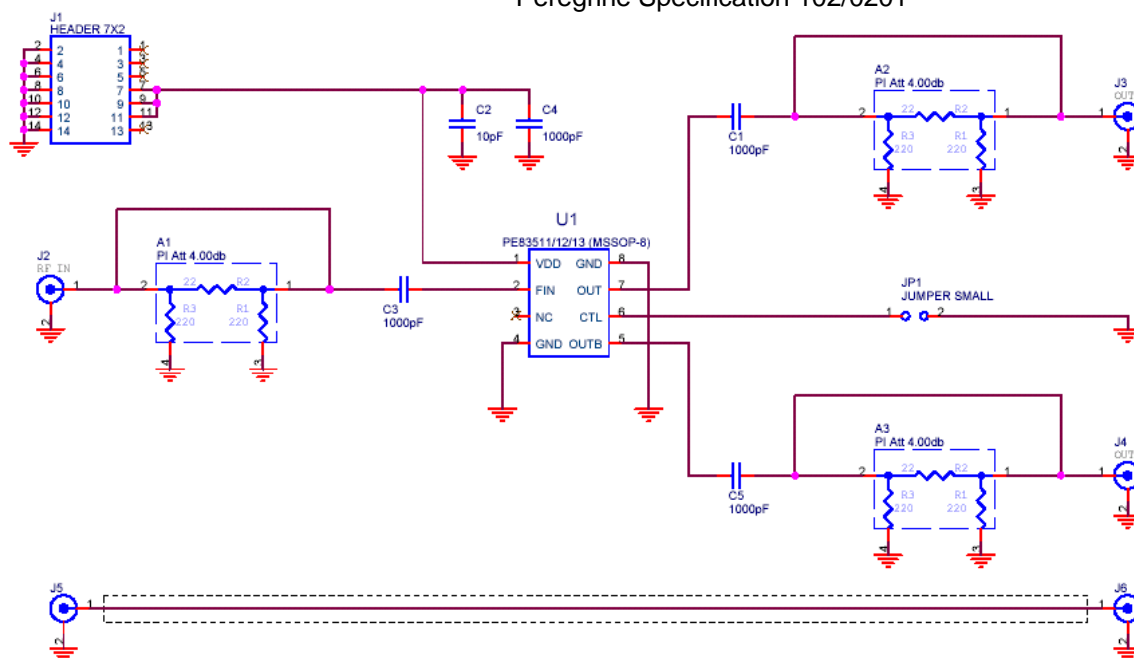

Figure 9. Package Drawing

8-lead MSOP

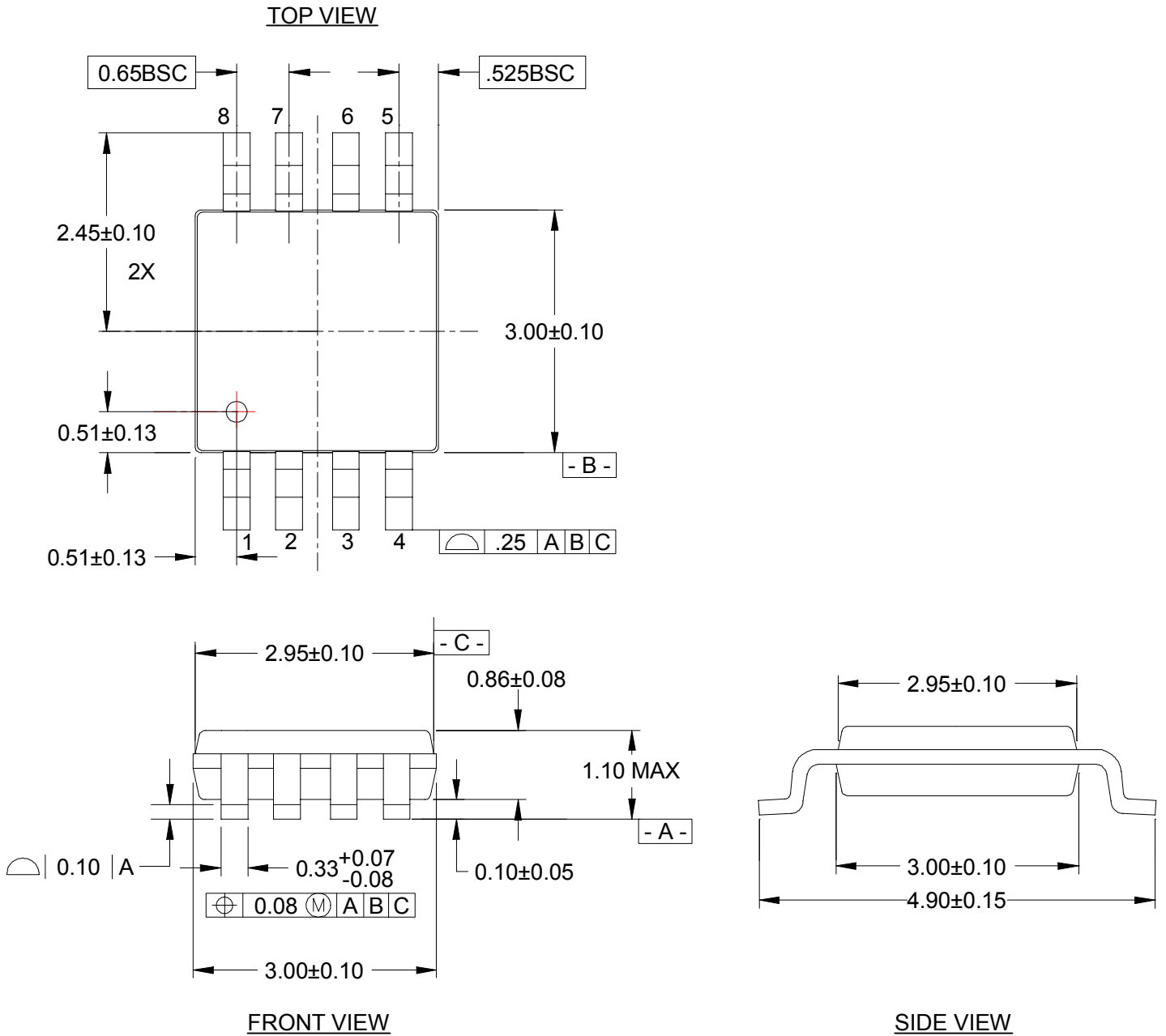
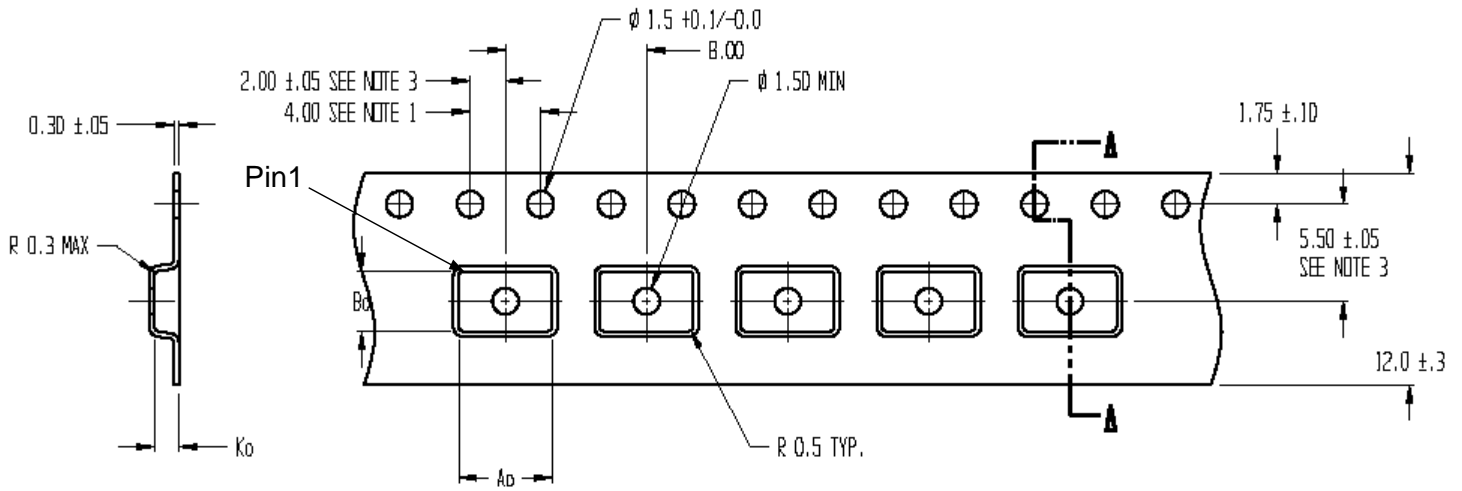

Figure 10. Tape and Reel Specifications

8-lead MSOP



Ad = 5.30
Bo = 3.40
Ko = 1.40

NOTES:

1. 10 SPROCKET HOLE PITCH CUMULATIVE TOLERANCE ±0.2
2. CAMBER IN COMPLIANCE WITH EIA 481
3. POCKET POSITION RELATIVE TO SPROCKET HOLE MEASURED AS TRUE POSITION OF POCKET, NOT POCKET HOLE

Table 4. Ordering Information

Order Code	Part Marking	Description	Package	Shipping Method
83513-01	PE83513	PE83513-08MSOP-50A	8-lead MSOP	50 units / Tube
83513-02	PE83513	PE83513-08MSOP-2000C	8-lead MSOP	2000 units / T&R
83513-00	PE83513-EK	PE83513-08MSOP-EK	Evaluation Kit	1 / Box

Sales Offices

The Americas

Peregrine Semiconductor Corporation

9450 Carroll Park Drive
San Diego, CA 92121
Tel: 858-731-9400
Fax: 858-731-9499

Europe

Peregrine Semiconductor Europe

Bâtiment Maine
13-15 rue des Quatre Vents
F-92380 Garches, France
Tel: +33-1-4741-9173
Fax : +33-1-4741-9173

Space and Defense Products

Americas:

Tel: 858-731-9453

Europe, Asia Pacific:

180 Rue Jean de Guiramand
13852 Aix-En-Provence Cedex 3, France
Tel: +33-4-4239-3361
Fax: +33-4-4239-7227

North Asia Pacific

Peregrine Semiconductor K.K.

Teikoku Hotel Tower 10B-6
1-1-1 Uchisaiwai-cho, Chiyoda-ku
Tokyo 100-0011 Japan
Tel: +81-3-3502-5211
Fax: +81-3-3502-5213

Peregrine Semiconductor, Korea

#B-2402, Kolon Tripolis, #210
Geumgok-dong, Bundang-gu, Seongnam-si
Gyeonggi-do, 463-480 S. Korea
Tel: +82-31-728-4300
Fax: +82-31-728-4305

South Asia Pacific

Peregrine Semiconductor, China

Shanghai, 200040, P.R. China
Tel: +86-21-5836-8276
Fax: +86-21-5836-7652

For a list of representatives in your area, please refer to our Web site at: www.psemi.com

Data Sheet Identification

Advance Information

The product is in a formative or design stage. The data sheet contains design target specifications for product development. Specifications and features may change in any manner without notice.

Preliminary Specification

The data sheet contains preliminary data. Additional data may be added at a later date. Peregrine reserves the right to change specifications at any time without notice in order to supply the best possible product.

Product Specification

The data sheet contains final data. In the event Peregrine decides to change the specifications, Peregrine will notify customers of the intended changes by issuing a DCN (Document Change Notice).

The information in this data sheet is believed to be reliable. However, Peregrine assumes no liability for the use of this information. Use shall be entirely at the user's own risk.

No patent rights or licenses to any circuits described in this data sheet are implied or granted to any third party.

Peregrine's products are not designed or intended for use in devices or systems intended for surgical implant, or in other applications intended to support or sustain life, or in any application in which the failure of the Peregrine product could create a situation in which personal injury or death might occur. Peregrine assumes no liability for damages, including consequential or incidental damages, arising out of the use of its products in such applications.

The Peregrine name, logo, and UTSi are registered trademarks and UltraCMOS and HaRP are trademarks of Peregrine Semiconductor Corp.