

PM75CTK060

FLAT-BASE TYPE
INSULATED PACKAGE

PM75CTK060



- 600V, 75A Current-sense 6kHz IGBT type inverter
- Built in IGBT gate drive circuit
- Built in Fault OC, SC, OT & UV protection Fault output
- 5.5/7.5kW class inverter application

APPLICATION

Air conditioner, motor control

OUTLINE DRAWING

Dimensions in mm

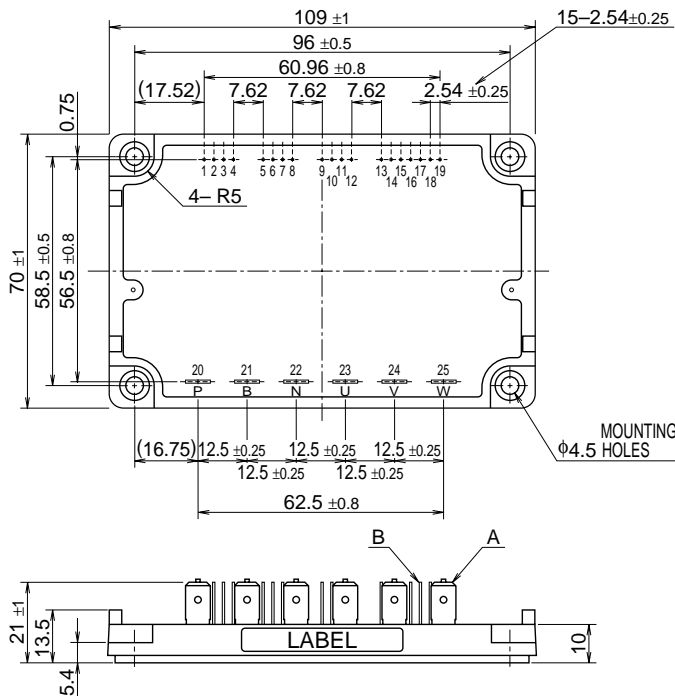

A · B : TERMINAL NAME

- | | | |
|---------|----------|--------|
| 1. VUPC | 10. NC | 19. FO |
| 2. NC | 11. WP | 20. P |
| 3. UP | 12. VWP1 | 21. NC |
| 4. VUP1 | 13. VNC | 22. N |
| 5. VVPC | 14. VN1 | 23. U |
| 6. NC | 15. NC | 24. V |
| 7. VP | 16. UN | 25. W |
| 8. VVP1 | 17. VN | |
| 9. VVPC | 18. WN | |

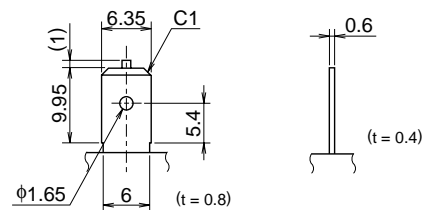

A : DETAIL

B : DETAIL

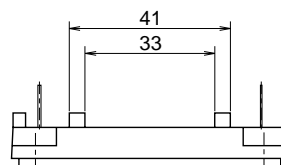

PM75CTK060

FLAT-BASE TYPE
INSULATED PACKAGE

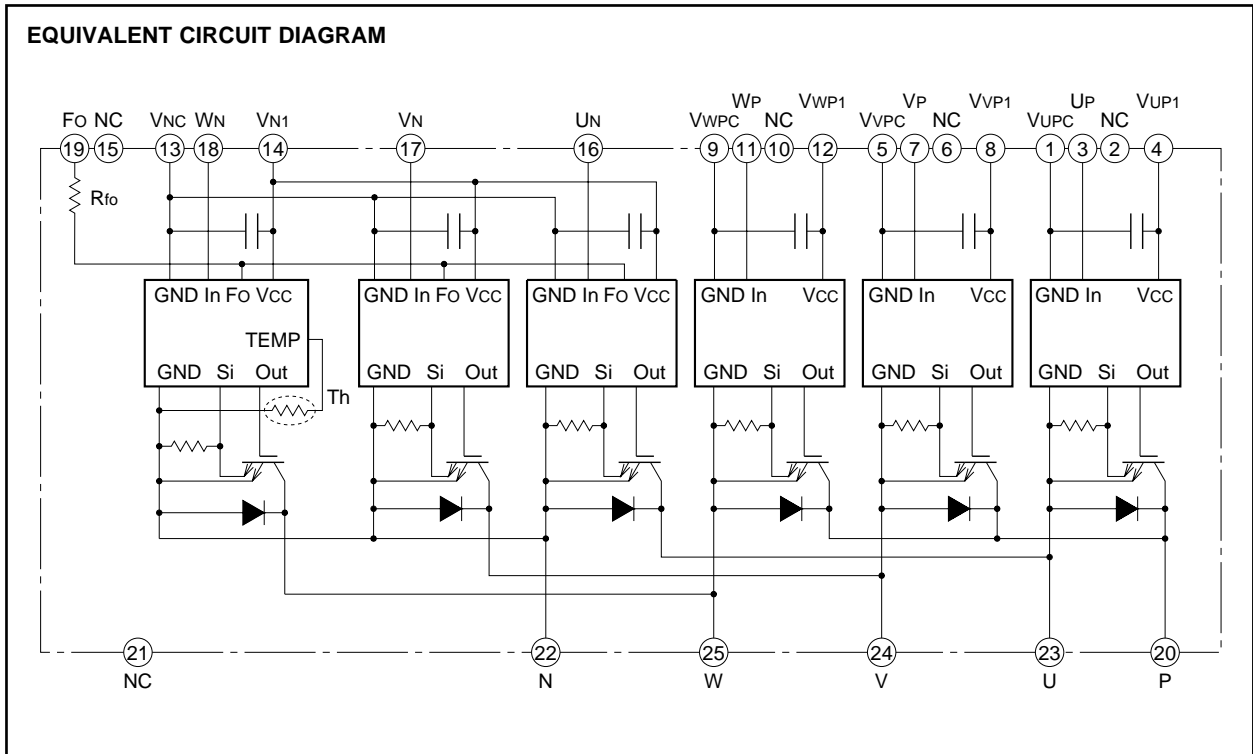

MAXIMUM RATINGS ($T_j = 25^\circ\text{C}$, unless otherwise noted)

INVERTER PART

Symbol	Parameter	Conditions	Ratings	Unit
V_{CES}	Collector-emitter voltage	$V_D = 15\text{V}$, $I_{CIN} = 10\text{mA}$	600	V
$\pm I_C$	Collector current	$T_C = 25^\circ\text{C}$	75	A
$\pm I_{CP}$	Collector current (peak)	$T_C = 25^\circ\text{C}$	150	A
P_C	Collector dissipation	$T_C = 25^\circ\text{C}$	134	W
T_j	Junction temperature		-20 ~ +150	$^\circ\text{C}$

CONTROL PART

Symbol	Parameter	Conditions	Ratings	Unit
V_D	Supply voltage	Applied between : $V_{UP1}-V_{UPC}$, $V_{VP1}-V_{VPC}$ $V_{WP1}-V_{WPC}$, $V_{N1}-V_{NC}$	20	V
I_{CIN}	Input current	Applied between : U_P-V_{UPC} , V_P-V_{VPC} , W_P-V_{WPC} , $U_N \cdot V_N \cdot W_N-V_{NC}$	20	mA
V_{FO}	Fault output supply voltage	Applied between : F_O-V_{NC}	20	V
I_{FO}	Fault output current	Sink current of F_O terminal	20	mA

PM75CTK060

FLAT-BASE TYPE
INSULATED PACKAGE

TOTAL SYSTEM

Symbol	Parameter	Conditions	Ratings	Unit
V _{CC(Prot)}	Supply voltage protected by OC & SC	V _D = 13.5 ~ 16.5V, Inverter part, T _j = 125°C start	400	V
V _{CC}	Supply voltage	Applied between : P-N, operating time	450	V
V _{CC(surge)}	Supply voltage (surge)	Applied between : P-N, surge and non-operating time	500	V
T _C	Module case operating temperature	(Note 1)	-20 ~ +100	°C
T _{stg}	Storage temperature		-40 ~ +125	°C
V _{iso}	Isolation voltage	60Hz, sinusoidal, AC · 1 min	2500	V _{rms}

Note 1 : T_C measuring point is as shown below.

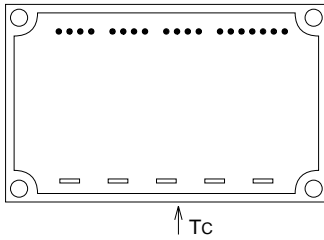

ELECTRICAL CHARACTERISTICS (T_j = 25°C, unless otherwise noted)

INVERTER PART

Symbol	Parameter	Test conditions	Limits			Unit
			Min.	Typ.	Max.	
V _{CE(sat)}	Collector-emitter saturation voltage	V _D = 15V, I _{CIN} = 10mA	—	1.8	2.7	V
		I _C = 75A, T _j = 25°C I _C = 75A, T _j = 125°C	—	1.85	2.78	
V _{EC}	FWDi forward voltage	-I _C = 75A, V _D = 15V, I _{CIN} = 0mA	—	2.2	3.3	V
t _{on}	Switching time	V _D = 15V, I _{CIN} = 0mA↔10mA V _{CC} = 300V, I _C = 75A T _j = 125°C (Per 1 arm) Inductive Load	0.6	1.2	2.4	μs
t _{tr}			—	0.15	0.3	μs
t _{c(on)}			—	0.5	1.1	μs
t _{off}			—	2.8	3.6	μs
t _{c(off)}			—	0.6	1.2	μs
I _{CES}	Collector-emitter cutoff current	V _{CE} = V _{CEs} , I _{CIN} = 0mA	—	—	1	mA
		T _j = 25°C T _j = 125°C	—	—	10	

CONTROL PART

Symbol	Parameter	Test conditions	Limits			Unit	
			Min.	Typ.	Max.		
I _D	Circuit current	V _D = 15V, I _{CIN} = 0mA	—	40	55	mA	
		V _{N1} -V _{Nc} V _{XP1} -V _{XPc}	—	13	18		
I _{th(ON)}	Input on threshold current	Applied between : UP-VUPC, VP-VVPC, WP-VWPC	1	3	5	mA	
I _{th(OFF)}	Input off threshold current	U _N · V _N · W _N -V _{Nc}	1	3	5	mA	
OC	Over current trip level	-20°C ≤ T _j ≤ 125°C, V _D = 15V	115	161	—	A	
SC	Short circuit trip level	-20°C ≤ T _j ≤ 125°C, V _D = 15V	—	241	—	A	
t _{off(OC)}	Over current delay time	V _D = 15V	—	10	—	μs	
OT	Over temperature protection	Base-plate	Trip level	100	110	120	°C
OT _r		Temperature detection, V _D = 15V	Reset level	—	90	—	°C
UV	Supply circuit under voltage protection	-20°C ≤ T _j ≤ 125°C	Trip level	11.5	12.0	12.5	V
UV _r			Reset level	—	12.5	—	V
I _{FO(H)}	Fault output current (Note 2)	V _D = 15V, V _{FO} = 15V	—	—	0.01	mA	
I _{FO(L)}			—	10	15		
t _{FO}	Minimum fault output pulse width (Note 2)	V _D = 15V	1.0	1.8	—	ms	

Note 2 : Fault output is given only when the internal OC, SC, OT & UV protection.
 Fault output of OC, SC protection operate by lower arm.
 Fault output of OC, SC protection given pulse.
 Fault output of OT, UV protection given pulse while over level. (OT is only N side)

PM75CTK060

FLAT-BASE TYPE
INSULATED PACKAGE

THERMAL RESISTANCES

Symbol	Parameter	Test conditions	Limits			Unit
			Min.	Typ.	Max.	
R _{th(j-c)Q}	Junction to case thermal resistances	Inverter IGBT part, per 1/6 module	—	—	0.93	°C / W
R _{th(j-c)F}		Inverter FWDi part, per 1/6 module	—	—	0.91	°C / W
R _{th(c-f)}	Contact thermal resistance	Case to fin, thermal grease applied, per 1 module	—	—	0.036	°C / W

MECHANICAL RATINGS AND CHARACTERISTICS

Symbol	Parameter	Test conditions	Limits			Unit
			Min.	Typ.	Max.	
—	Mounting torque	Mounting screw : M4	0.98	1.18	1.47	N·m
—	Weight		10	12	15	kg·cm
—	Weight		—	150	—	g

RECOMMENDED CONDITIONS FOR USE

Symbol	Parameter	Test conditions	Ratings	Unit
V _{CC}	Supply voltage	Applied between : P-N	≤ 400	V
V _D		Applied between : V _{UP1} -V _{UPC} , V _{VP1} -V _{VPC} V _{WP1} -V _{WPC} , V _{UN1} -V _{UNC} (Note 3)	15 ± 1.5	V
I _{CIN(ON)}	Input on current	Applied between : UP, VP, WP, UN, VN, WN	≥ 5	mA
I _{CIN(OFF)}	Input off current		≤ 1	mA
f _{PWM}	PWM input frequency	Using application circuit Opto-coupler's input signal	≤ 8	kHz
t _{dead}	Arm shoot-through blocking time	Using application circuit Opto-coupler's input signal	≥ 3	μs

Note 3 : Permissible ripple value : dv/dt ≤ ±5V/μs, V_{ripple} ≤ 2V_{P-P}

PM75CTK060

FLAT-BASE TYPE
INSULATED PACKAGE

PERFORMANCE CURVES

OUTPUT CHARACTERISTICS (TYPICAL)

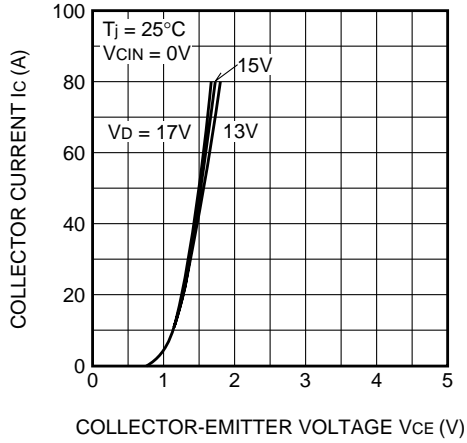

COLLECTOR-EMITTER SATURATION VOLTAGE CHARACTERISTICS (TYPICAL)

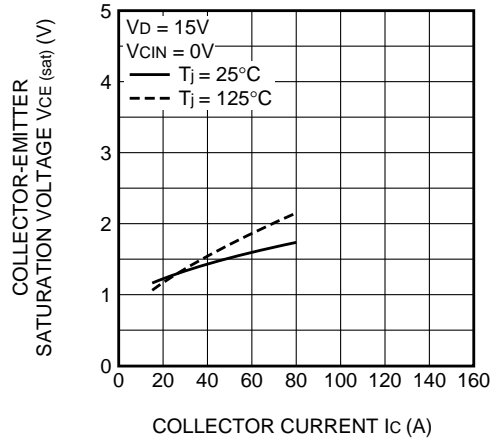

COLLECTOR-EMITTER SATURATION VOLTAGE VS. SUPPLY VOLTAGE (TYPICAL)

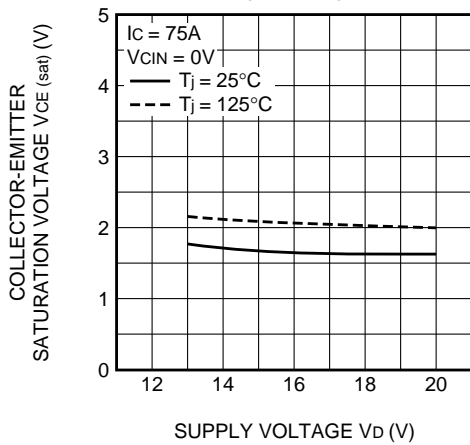

SWITCHING TIME VS. COLLECTOR CURRENT (TYPICAL)

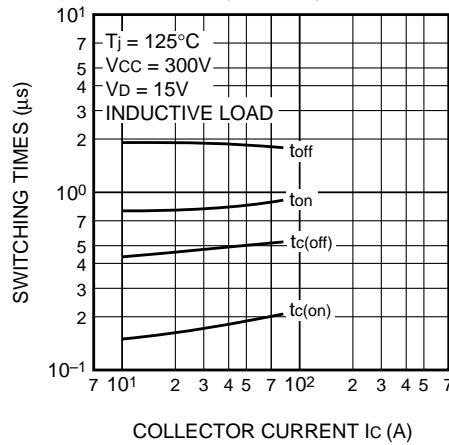

FREE-WHEEL DIODE FORWARD CHARACTERISTICS (TYPICAL)

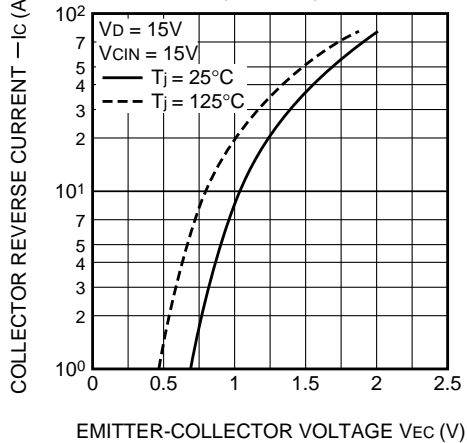

REVERSE RECOVERY CHARACTERISTICS OF FREE-WHEEL DIODE (TYPICAL)

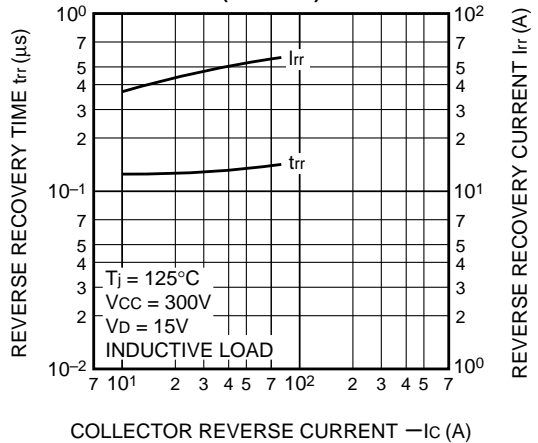

PM75CTK060

FLAT-BASE TYPE
INSULATED PACKAGE

