

Features

- Glass Passivated Die Construction
- Fast Switching for High Efficiency
- Surge Overload Rating to 50A Peak
- Low Reverse Leakage Current
- **Lead Free Finish, RoHS Compliant (Note 4)**

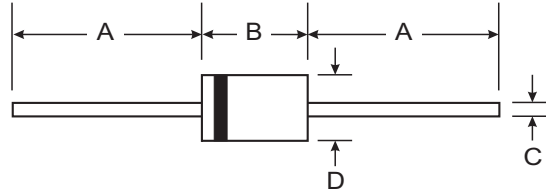

Mechanical Data

- Case: DO-41, DO-15
- Case Material: Molded Plastic. UL Flammability Classification Rating 94V-0
- Moisture Sensitivity: Level 1 per J-STD-020C
- Terminals: Finish — Tin. Plated Leads Solderable per MIL-STD-202, Method 208 (E3)
- Polarity: Cathode Band
- Marking: Type Number
- Ordering Information: See Last Page
- DO-41 Weight: 0.35 grams (approximate)
- DO-15 Weight: 0.40 grams (approximate)

Dim	DO-41		DO-15	
	Min	Max	Min	Max
A	25.40	—	25.40	—
B	4.06	5.21	5.50	7.62
C	0.71	0.864	0.686	0.889
D	2.00	2.72	2.60	3.60
All Dimensions in mm				

"GS" Suffix Designates DO-41 Package
"G" Suffix Designates DO-15 Package

Maximum Ratings and Electrical Characteristics @ T_A = 25°C unless otherwise specified

Single phase, half wave, 60Hz, resistive or inductive load.
For capacitive load, derate current by 20%.

Characteristic	Symbol	PR1501 G/GS	PR1502 G/GS	PR1503 G/GS	PR1504 G/GS	PR1505 G/GS	PR1506 G/GS	PR1507 G/GS	Unit
Peak Repetitive Reverse Voltage	V _{RRM}	50	100	200	400	600	800	1000	V
Working Peak Reverse Voltage	V _{RWM}								
DC Blocking Voltage (Note 5)	V _R								
RMS Reverse Voltage	V _{R(RMS)}	35	70	140	280	420	560	700	V
Average Rectified Output Current (Note 1)	I _O	1.5							A
Non-Repetitive Peak Forward Surge Current 8.3ms Single half sine-wave Superimposed on Rated Load	I _{FSM}	50							A
Forward Voltage	V _{FM}	1.3							V
Peak Reverse Current (Note 5)	I _{RM}	5.0 200							μA
Reverse Recovery Time (Note 3)	t _{rr}	150			250		500		ns
Typical Total Capacitance (Note 2)	C _T	25							pF
Typical Thermal Resistance Junction to Ambient	R _{θJA}	65							°C/W
Operating and Storage Temperature Range	T _j , T _{STG}	-65 to +150							°C

- Notes:
1. Valid provided that leads are maintained at ambient temperature at a distance of 9.5mm from the case.
 2. Measured at 1.0MHz and applied reverse voltage of 4.0V DC.
 3. Measured with I_F = 0.5A, I_R = 1.0A, I_{rr} = 0.2 5A. See figure 5.
 4. RoHS revision 13.2.2003. Glass and high temperature solder exemptions applied, see *EU Directive Annex Notes 5 and 7*.
 5. Short duration pulse test used to minimize self-heating effect.

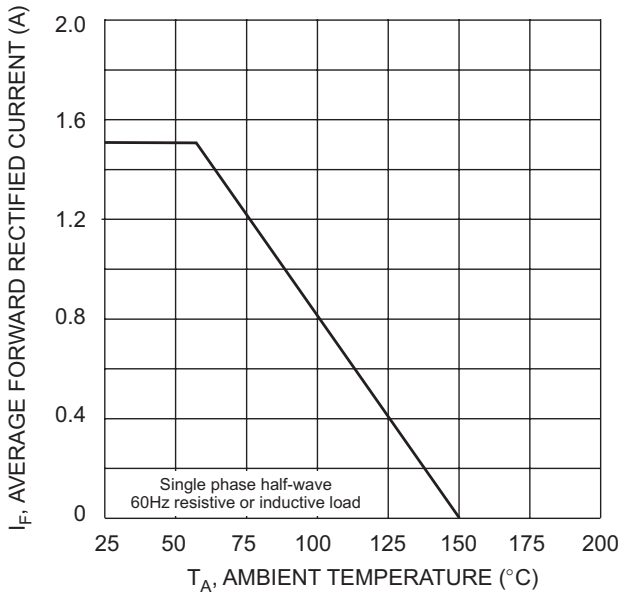

Fig. 1 Forward Derating Curve

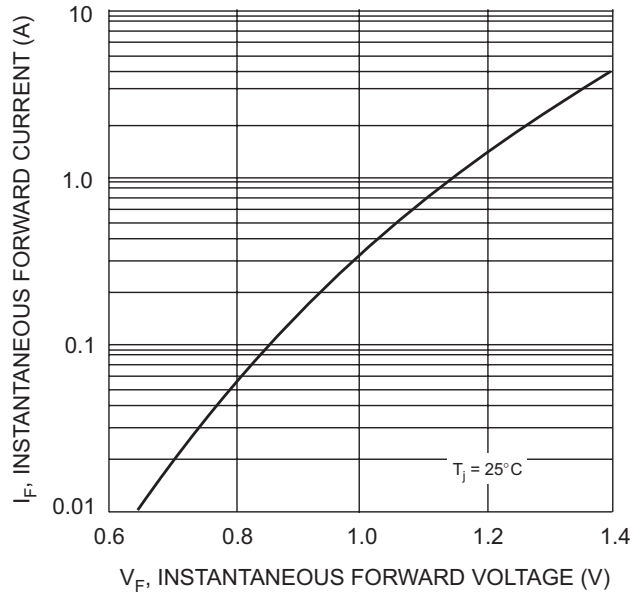

Fig. 2 Typical Forward Characteristics

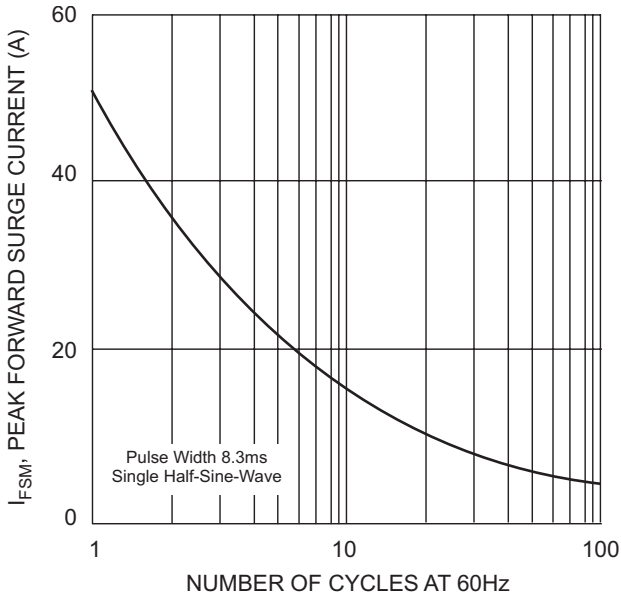

Fig. 3 Peak Forward Surge Current

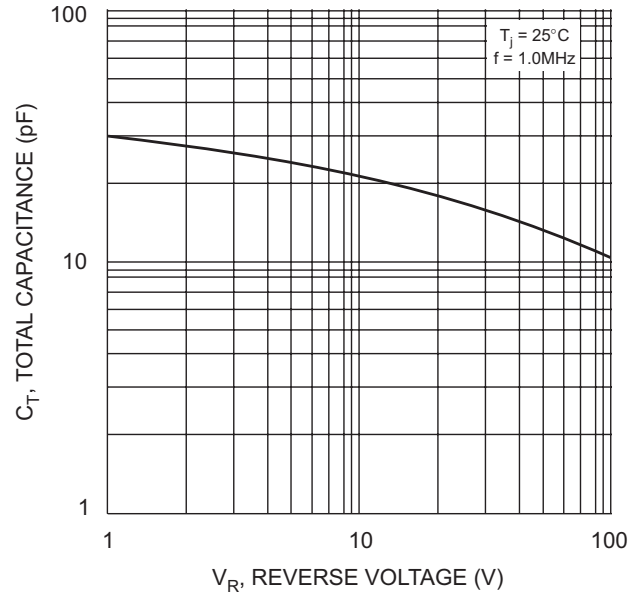
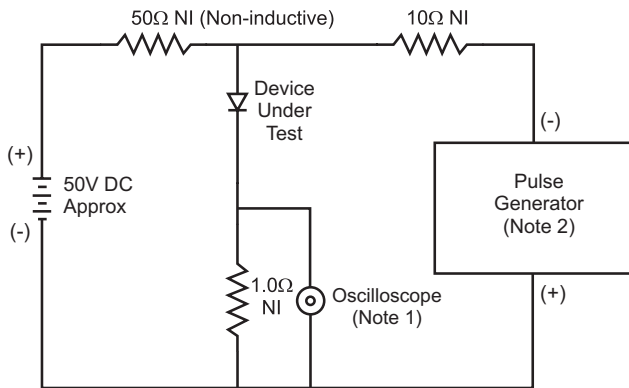
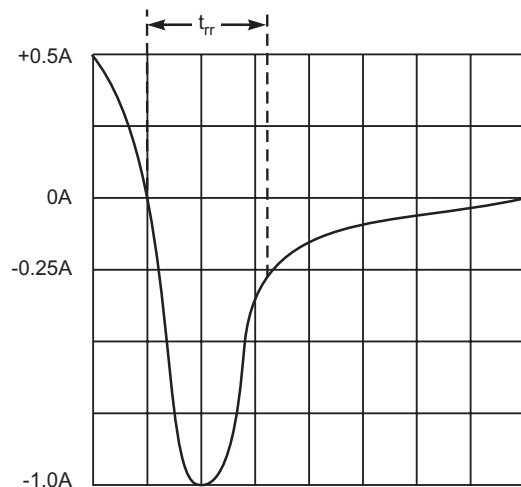

Fig. 4 Typical Total Capacitance



- Notes:
1. Rise Time = 7.0ns max. Input Impedance = 1.0MΩ, 22pF.
 2. Rise Time = 10ns max. Input Impedance = 50Ω.



Set time base for 50/100 ns/cm

Fig. 5 Reverse Recovery Time Characteristic and Test Circuit

Ordering Information (Note 6)

Device	Packaging	Shipping
PR1501G-B	DO-15	1K/Bulk
PR1501G-T	DO-15	4K/Tape & Reel, 13-inch
PR1502G-B	DO-15	1K/Bulk
PR1502G-T	DO-15	4K/Tape & Reel, 13-inch
PR1503G-B	DO-15	1K/Bulk
PR1503G-T	DO-15	4K/Tape & Reel, 13-inch
PR1504G-B	DO-15	1K/Bulk
PR1504G-T	DO-15	4K/Tape & Reel, 13-inch
PR1505G-B	DO-15	1K/Bulk
PR1505G-T	DO-15	4K/Tape & Reel, 13-inch
PR1506G-B	DO-15	1K/Bulk
PR1506G-T	DO-15	4K/Tape & Reel, 13-inch
PR1507G-B	DO-15	1K/Bulk
PR1507G-T	DO-15	4K/Tape & Reel, 13-inch
PR1501GS-A	DO-41	5K/Ammo Pack
PR1501GS-B	DO-41	1K/Bulk
PR1501GS-T	DO-41	5K/Tape & Reel, 13-inch
PR1502GS-A	DO-41	5K/Ammo Pack
PR1502GS-B	DO-41	1K/Bulk
PR1502GS-T	DO-41	5K/Tape & Reel, 13-inch
PR1503GS-A	DO-41	5K/Ammo Pack
PR1503GS-B	DO-41	1K/Bulk
PR1503GS-T	DO-41	5K/Tape & Reel, 13-inch
PR1504GS-A	DO-41	5K/Ammo Pack
PR1504GS-B	DO-41	1K/Bulk
PR1504GS-T	DO-41	5K/Tape & Reel, 13-inch
PR1505GS-A	DO-41	5K/Ammo Pack
PR1505GS-B	DO-41	1K/Bulk
PR1505GS-T	DO-41	5K/Tape & Reel, 13-inch
PR1506GS-A	DO-41	5K/Ammo Pack
PR1506GS-B	DO-41	1K/Bulk
PR1506GS-T	DO-41	5K/Tape & Reel, 13-inch
PR1507GS-A	DO-41	5K/Ammo Pack
PR1507GS-B	DO-41	1K/Bulk
PR1507GS-T	DO-41	5K/Tape & Reel, 13-inch

Notes: 6. For packaging details, visit our website at <http://www.diodes.com/datasheets/ap02008.pdf>.

IMPORTANT NOTICE

Diodes Incorporated and its subsidiaries reserve the right to make modifications, enhancements, improvements, corrections or other changes without further notice to any product herein. Diodes Incorporated does not assume any liability arising out of the application or use of any product described herein; neither does it convey any license under its patent rights, nor the rights of others. The user of products in such applications shall assume all risks of such use and will agree to hold Diodes Incorporated and all the companies whose products are represented on our website, harmless against all damages.

LIFE SUPPORT

Diodes Incorporated products are not authorized for use as critical components in life support devices or systems without the expressed written approval of the President of Diodes Incorporated.