

### Absolute maximum ratings

( $T_a=25^\circ\text{C}$ )

Symbol	Ratings	Unit
$V_{CB0}$	60	V
$V_{CEO}$	60	V
$V_{EBO}$	6	V
$I_c$	4	A
$I_{cP}$	6 ( $PW \leq 1\text{ms}$ , $D_u \leq 50\%$ )	A
$I_B$	0.5	A
$P_T$	2.6 ( $T_a=25^\circ\text{C}$ )	W
$T_j$	150	$^\circ\text{C}$
$T_{stg}$	-40 to +150	$^\circ\text{C}$

### Electrical characteristics

( $T_a=25^\circ\text{C}$ )

Symbol	Specification			Unit	Conditions
	min	typ	max		
$I_{CBO}$			10	$\mu\text{A}$	$V_{CB}=60\text{V}$
$I_{EBO}$			10	mA	$V_{EB}=6\text{V}$
$V_{CEO}$	60			V	$I_c=10\text{mA}$
$h_{FE}$	2000		12000		$V_{CE}=4\text{V}$ , $I_c=3\text{A}$
$V_{CE(sat)}$			1.5	V	$I_c=3\text{A}$ , $I_B=6\text{mA}$
$V_{BE(sat)}$			2.0	V	
$V_{FEC}$			1.8	V	$I_{FEC}=1\text{A}$
$t_{on}$		1.0		$\mu\text{s}$	$V_{CC} \doteq 30\text{V}$ , $I_c=3\text{A}$ ,
$t_{stg}$		4.0		$\mu\text{s}$	
$t_f$		1.5		$\mu\text{s}$	$I_{B1}=-I_{B2}=10\text{mA}$
$f_T$		75		MHz	$V_{CE}=12\text{V}$ , $I_E=-0.1\text{A}$
$C_{ob}$		50		pF	$V_{CB}=10\text{V}$ , $f=1\text{MHz}$

### Equivalent circuit diagram

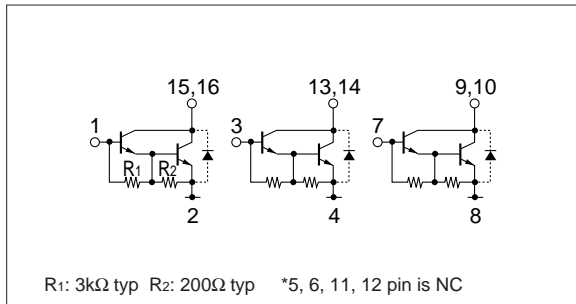

### Characteristic curves

$I_c$ - $V_{CE}$  Characteristics (Typical)

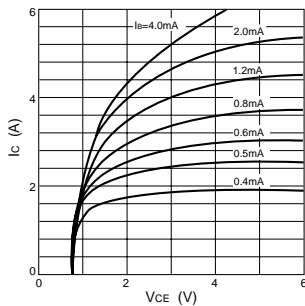

$h_{FE}$ - $I_c$  Characteristics (Typical)

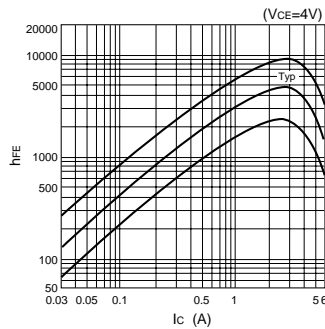

$h_{FE}$ - $I_c$  Temperature Characteristics (Typical)

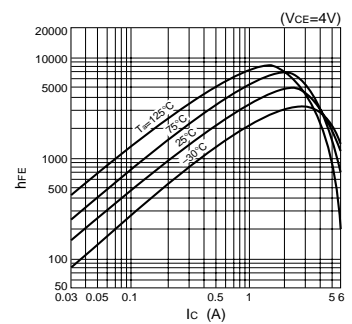

$V_{CE(sat)}$ - $I_c$  Temperature Characteristics (Typical)

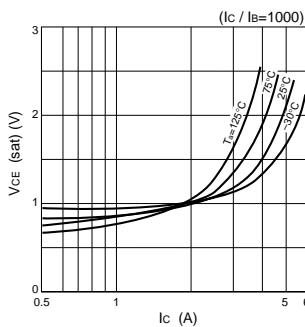

$V_{CE(sat)}$ - $I_B$  Characteristics (Typical)

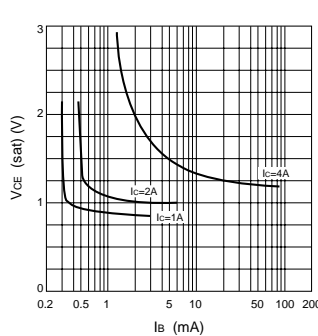

$I_c$ - $V_{BE}$  Temperature Characteristics (Typical)

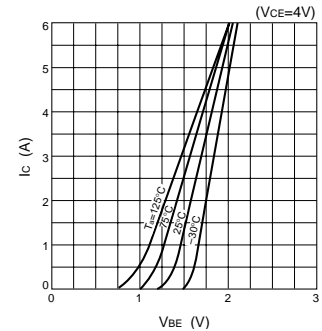

$\theta_{j-a}$ -PW Characteristics

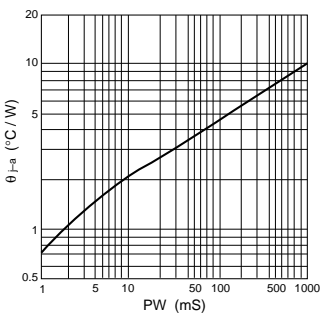

$P_T$ - $T_a$  Characteristics

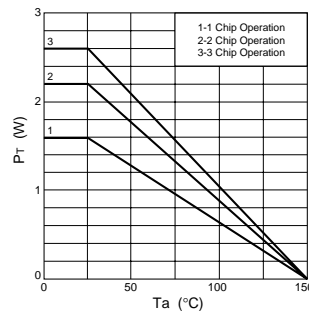

Safe Operating Area (SOA)

