

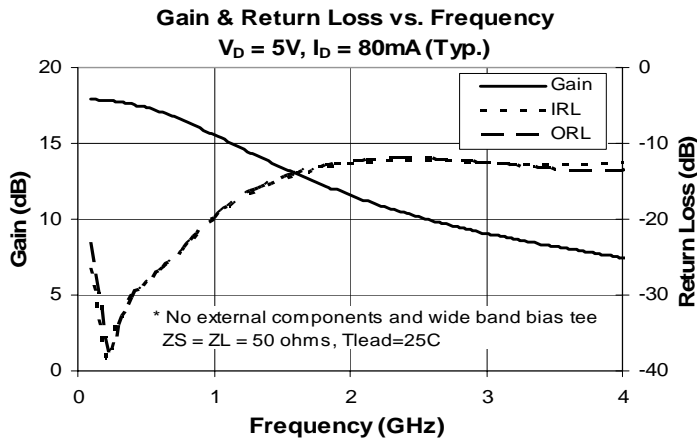

Product Description

Sirenza Microdevices' SGC-6386Z is a high performance SiGe HBT MMIC amplifier utilizing a Darlington configuration with an active bias network. The active bias network provides stable current over temperature and process Beta variations. Designed to run directly from a 5V supply, the SGC-6386Z does not require a drop resistor as compared to typical Darlington amplifiers. The SGC-6386Z product is designed for high linearity 5V gain block applications that require small size and minimal external components. It is internally matched to 50 ohms.

The matte tin finish on Sirenza's lead-free "Z" package is applied using a post annealing process to mitigate tin whisker formation and is RoHS compliant per EU Directive 2002/95. The package body is manufactured with green molding compounds that contain no antimony trioxide or halogenated fire retardants.



Preliminary Information

SGC-6386Z



50-4000 MHz Silicon Germanium Cascadable Gain Block



Product Features

- Single Fixed 5V Supply
- Supply Drop Resistor not required
- Patented Self Bias Circuitry
- $P_{1dB} = 18.3$ dBm at 1950 MHz
- $IP_3 = 34.3$ dBm at 1950 MHz
- Robust 1000V ESD, Class 1C HBM

Applications

- PA Driver Amplifier
- Cellular, PCS, GSM, UMTS
- IF Amplifier
- Wireless Data, Satellite

Typical performance with appropriate application circuit

Symbol	Parameters	Units	Frequency	Min.	Typ.	Max.
G	Small Signal Gain	dB	850 MHz 1950 MHz		16.3 11.9	
P_{1dB}	Output Power at 1dB Compression	dBm	850 MHz 1950 MHz		19.3 18.3	
OIP_3	Output Third Order Intercept Point	dBm	850 MHz 1950 MHz		35.6 34.3	
IRL	Input Return Loss	dB	1950 MHz		18.0	
ORL	Output Return Loss	dB	1950 MHz		17.0	
NF	Noise Figure	dB	1930 MHz		4.2	
V_D	Device Operating Voltage	V			5.0	
I_D	Device Operating Current	mA			80	
$R_{th, j-l}$	Thermal Resistance (junction to lead)	$^{\circ}C/W$			106	

Test Conditions: $V_D = 5.0V$ $I_D = 80mA$ Typ. OIP_3 Tone Spacing = 1MHz $T_L = 25^{\circ}C$
 $Z_S = Z_L = 50$ Ohms Pout per tone = 0 dBm

The information provided herein is believed to be reliable at press time. Sirenza Microdevices assumes no responsibility for inaccuracies or omissions. Sirenza Microdevices assumes no responsibility for the use of this information, and all such information shall be entirely at the user's own risk. Prices and specifications are subject to change without notice. No patent rights or licenses to any of the circuits described herein are implied or granted to any third party. Sirenza Microdevices does not authorize or warrant any Sirenza Microdevices product for use in life-support devices and/or systems. Copyright 2005 Sirenza Microdevices, Inc.. All worldwide rights reserved.

Typical RF Performance at Key Operating Frequencies (Application Circuit)

Symbol	Parameter	Unit	Frequency (MHz)					
			100 - 1000MHz App. Circuit			1000 - 2200MHz App. Circuit		
			100	500	850	1000	1950	2200
G	Small Signal Gain	dB	17.5	17.3	16.2	15.1	11.9	11.1
OIP ₃	Output Third Order Intercept Point	dBm	35.8	36.2	35.6	34.9	34.3	33.6
P _{1dB}	Output Power at 1dB Compression	dBm	19.4	19.7	19.3	18.9	18.3	18.0
IRL	Input Return Loss	dB	10.0	35.0	21.0	12.0	18.0	16.0
ORL	Output Return Loss	dB	12.0	20.0	22.0	15.0	17.0	15.0
S ₁₂	Reverse Isolation	dB	21.0	21.0	21.0	21.0	19.0	18.0
NF	Noise Figure	dB	3.1	3.3	3.4	3.5	4.2	4.3

Test Conditions: V_D = 5V I_D = 80mA Typ. OIP₃ Tone Spacing = 1MHz, Pout per tone = 0 dBm
T_L = 25°C Z_S = Z_L = 50 Ohms

NF vs. Frequency (V_D = 5V, I_D = 80mA Typ.)

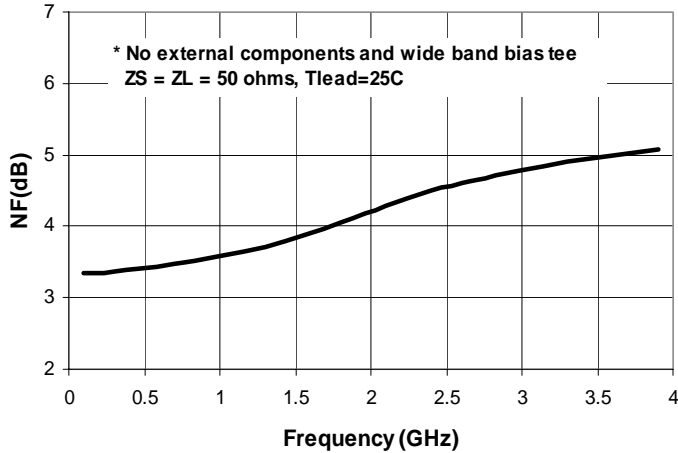

Absolute Maximum Ratings

Parameter	Absolute Limit
Max Device Current (I _{CE})	120 mA
Max Device Voltage (V _{CE})	6.5 V
Max. RF Input Power* (See Note)	+18 dBm
Max. Junction Temp. (T _J)	+150°C
Operating Temp. Range (T _L)	-40°C to +85°C
Max. Storage Temp.	+150°C

*Note: Load condition, Z_L = 50 Ohms

Operation of this device beyond any one of these limits may cause permanent damage. For reliable continuous operation, the device voltage and current must not exceed the maximum operating values specified in the table on page one.

Bias Conditions should also satisfy the following expression:

$$I_D V_D < (T_J - T_L) / R_{TH, j-l} \quad T_L = T_{LEAD}$$

I_d vs. V_d Vs. Temperature

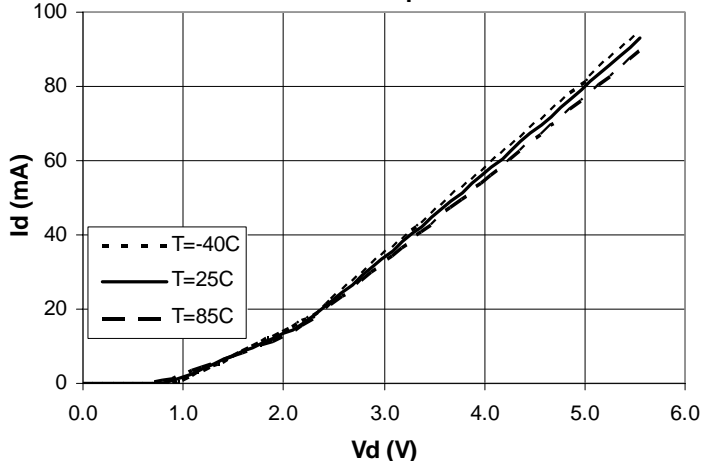

Reliability & Qualification Information

Parameter	Rating
ESD Rating - Human Body Model (HBM)	Class 1C
Moisture Sensitivity Level	MSL 1

This product qualification report can be downloaded at
www.sirenza.com



Caution: ESD sensitive

Appropriate precautions in handling, packaging and testing devices must be observed.

Typical RF Performance, 100-1000 MHz Application Circuit
 (Bias: $V_D = 5.0$ V, $I_D = 80$ mA (Typ.))

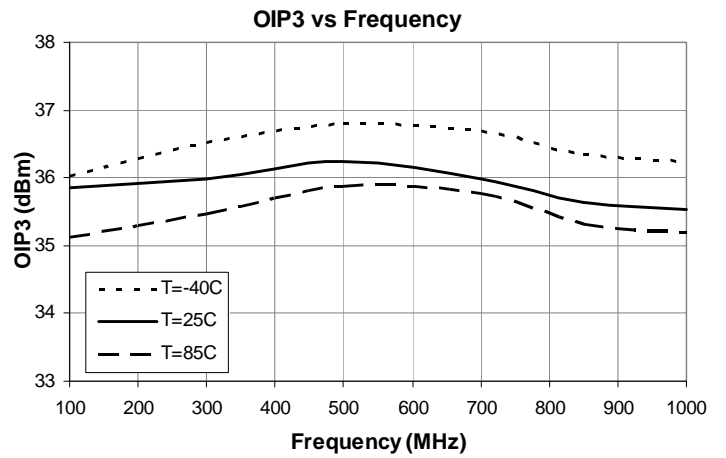
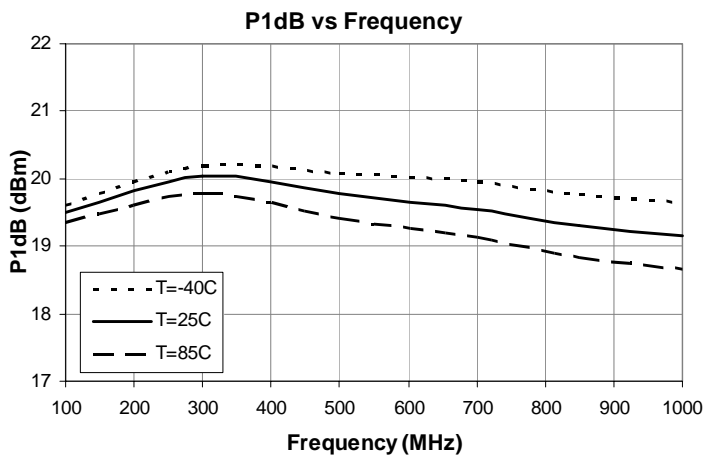
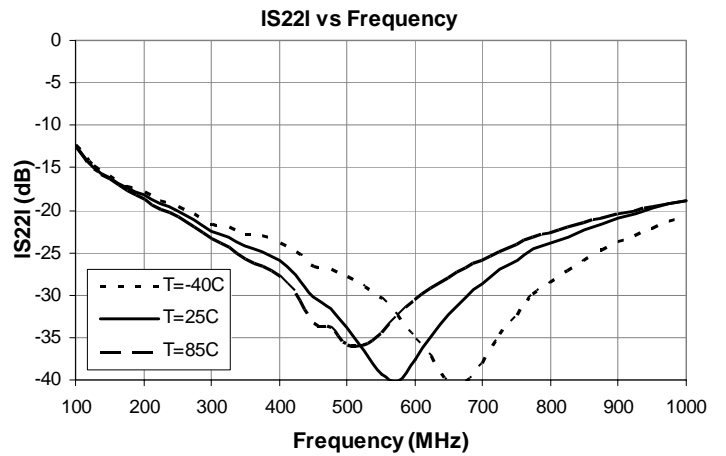
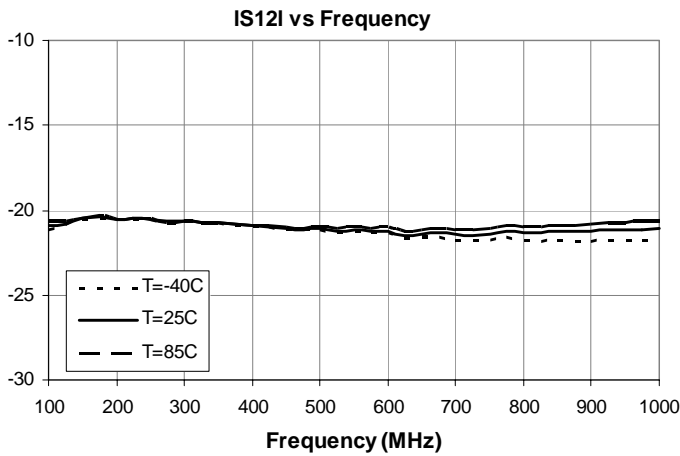
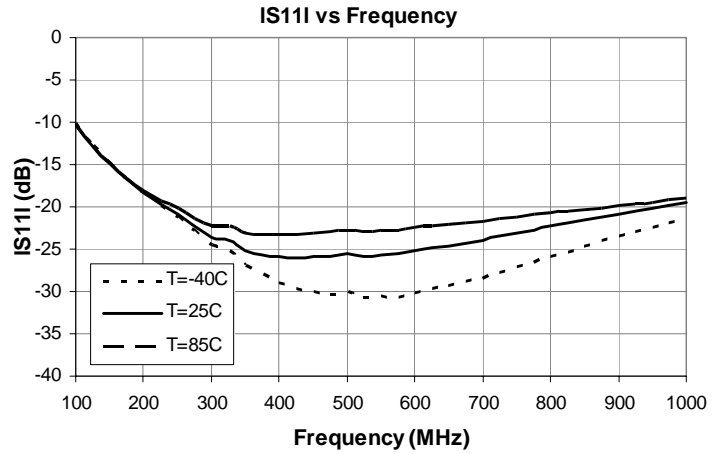
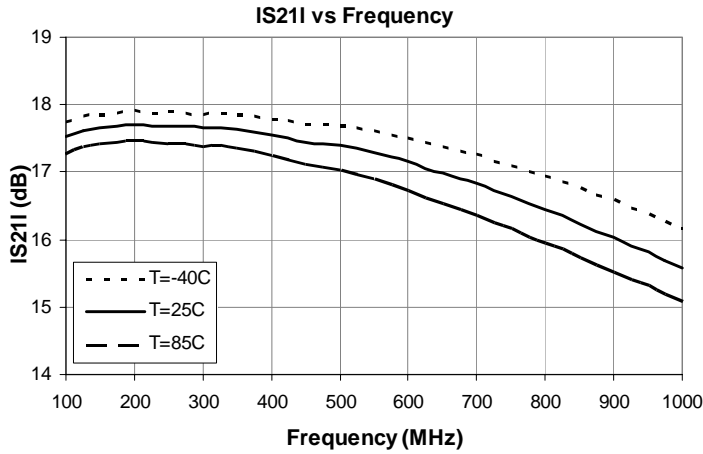

Typical RF Performance, 1000-2200 MHz Application Circuit
 (Bias: $V_D = 5.0$ V, $I_D = 80$ mA (Typ.))

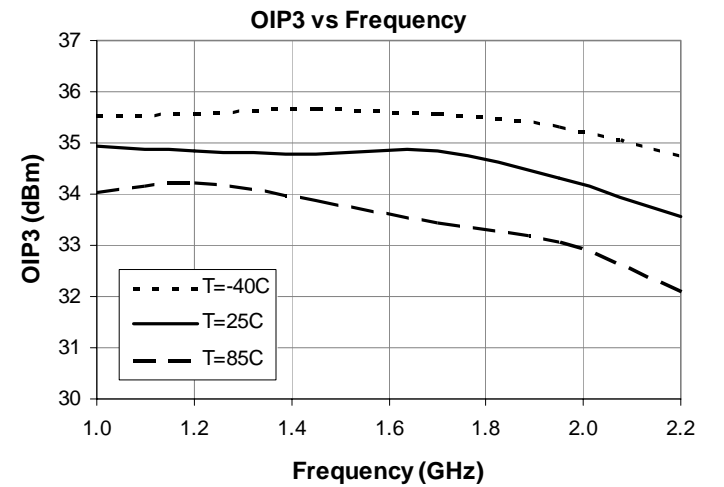
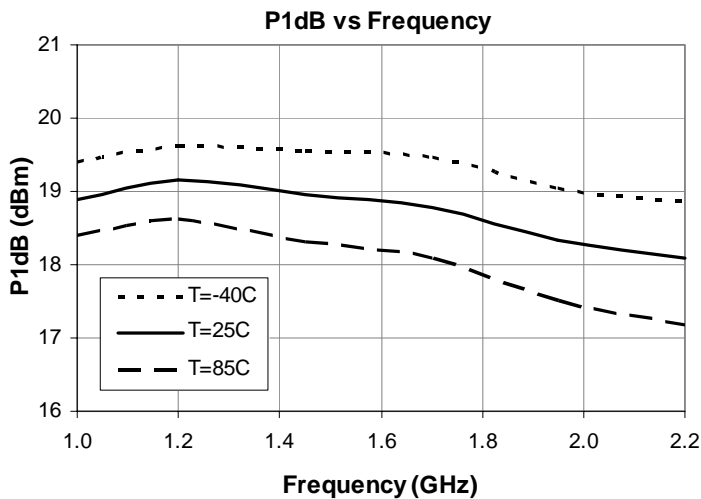
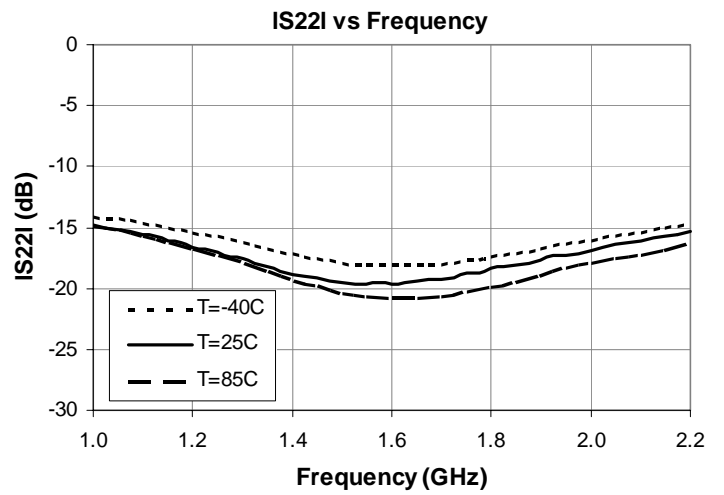
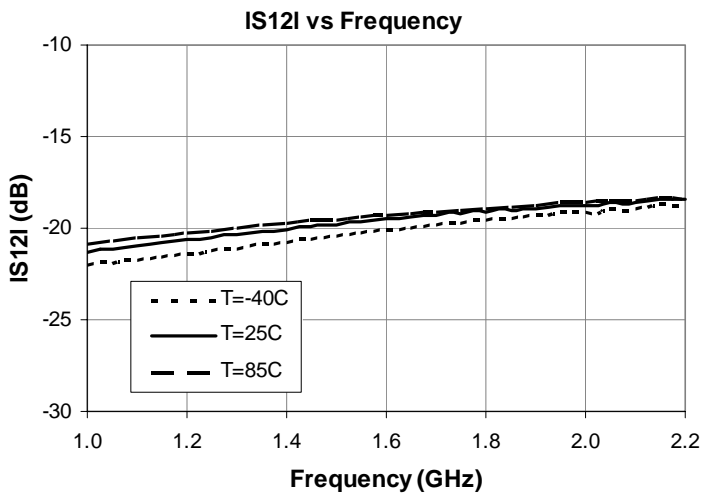
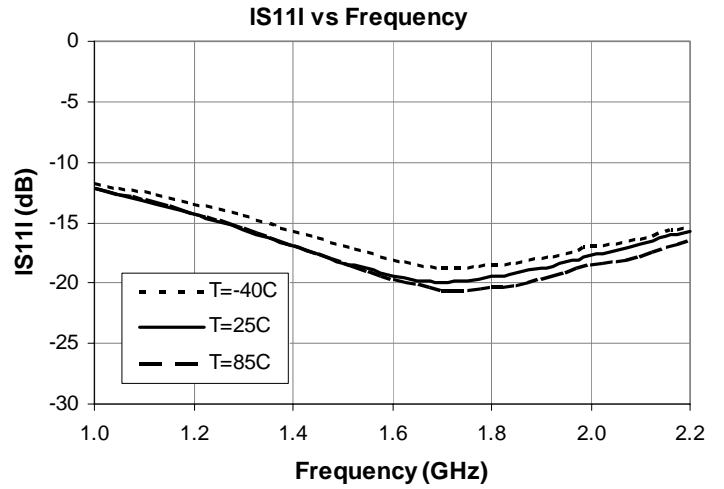
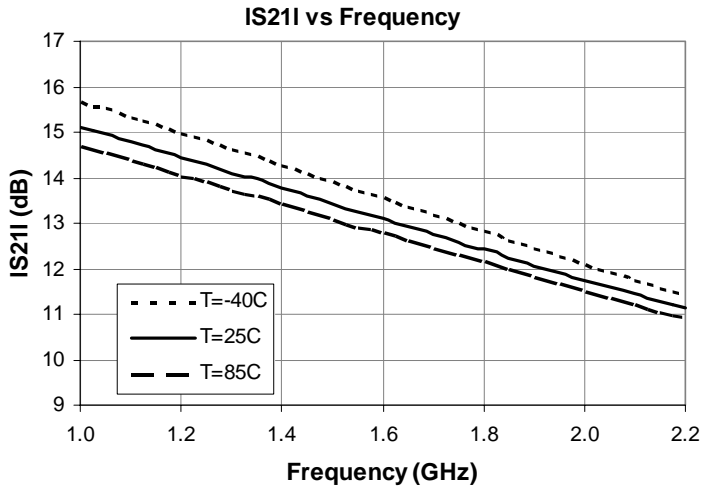

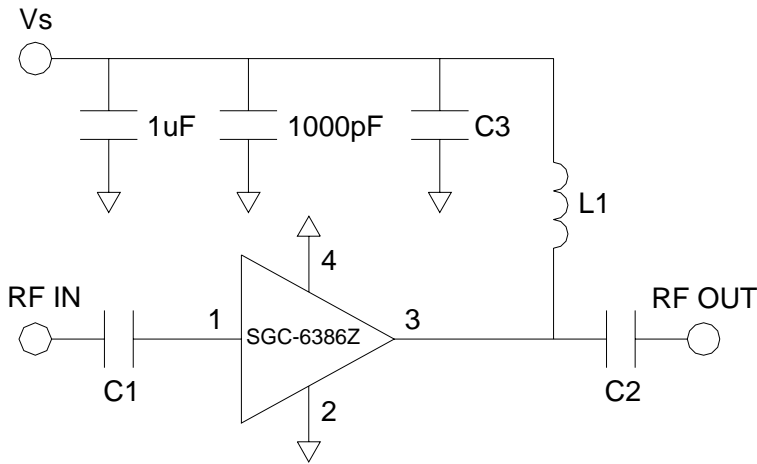

Application Circuit Element Values		
Reference Designator	100-1000MHz	1000-2200MHz
C1	1000pF	6.8pF
C2	100pF	6.8pF
C3	100pF	6.8pF
L1	100nH	39nH

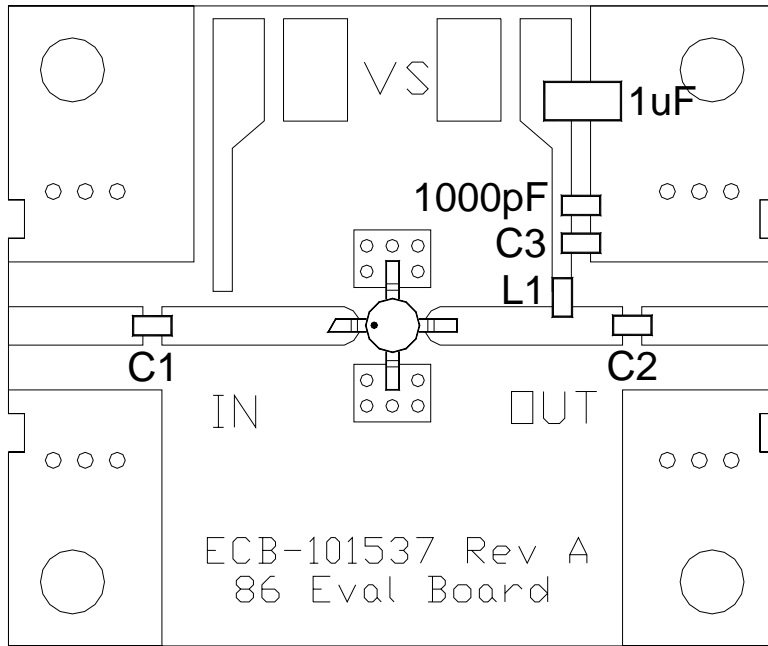

Mounting Instructions

1. Use a large ground pad area under device pins 2 and 4 with many plated through-holes as shown.
2. We recommend 1 or 2 ounce copper. Measurements for this data sheet were made on a 31 mil thick FR-4 board with 1 ounce copper on both sides.

Part Identification Marking & Pinout

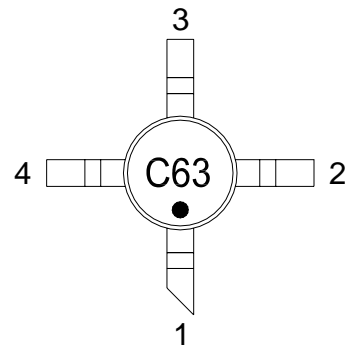

Pin #	Function	Description
1	RF IN	RF input pin. This pin requires the use of an external DC blocking capacitor chosen for the frequency of operation
2,4	GND	Connection to ground. Use via holes as close to the device ground leads as possible to reduce ground inductance and achieve optimum RF performance
3	RF OUT / DCBIAS	RF output and bias pin. This pin requires the use of an external DC blocking capacitor chosen for the frequency of operation.

Part Number	Package / Lead Composition	Reel Size	Devices / Reel
SGC-6386Z	Lead Free, RoHS Compliant	13"	3000

86 PCB Pad Layout

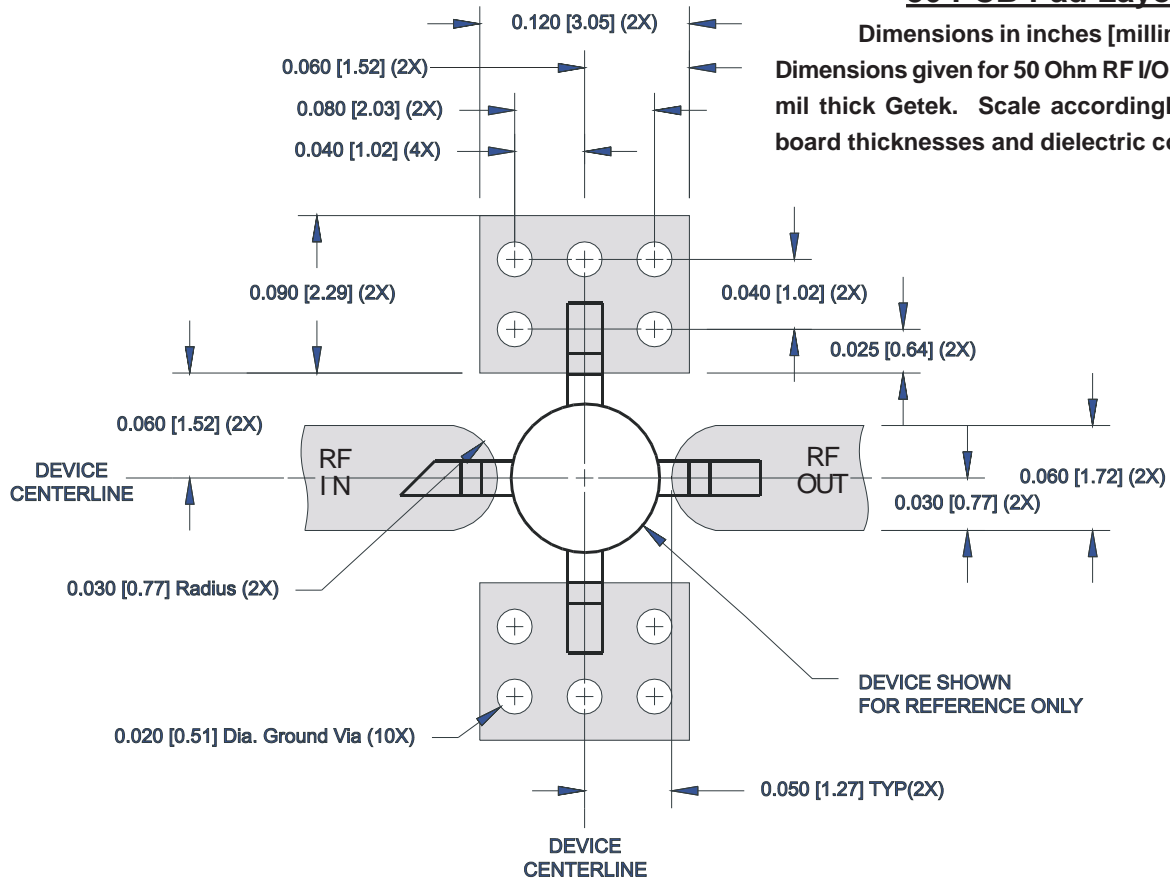

86 Nominal Package Dimensions

Dimensions in inches [millimeters]

A link to the 86 package outline drawing with full dimensions and tolerances may be found on the product web page at www.sirenza.com.

