



N- and P-Channel 20-V (D-S) MOSFET

CHARACTERISTICS

- N- and P-Channel Vertical DMOS
- Macro Model (Subcircuit Model)
- Level 3 MOS
- Apply for both Linear and Switching Application
- Accurate over the -55 to 125°C Temperature Range
- Model the Gate Charge, Transient, and Diode Reverse Recovery Characteristics

DESCRIPTION

The attached spice model describes the typical electrical characteristics of the n- and p-channel vertical DMOS. The subcircuit model is extracted and optimized over the -55 to 125°C temperature ranges under the pulsed 0-V to 4.5-V gate drive. The saturated output impedance is best fit at the gate bias near the threshold voltage.

A novel gate-to-drain feedback capacitance network is used to model the gate charge characteristics while avoiding convergence difficulties of the switched C_{gd} model. All model parameter values are optimized to provide a best fit to the measured electrical data and are not intended as an exact physical interpretation of the device.

SUBCIRCUIT MODEL SCHEMATIC

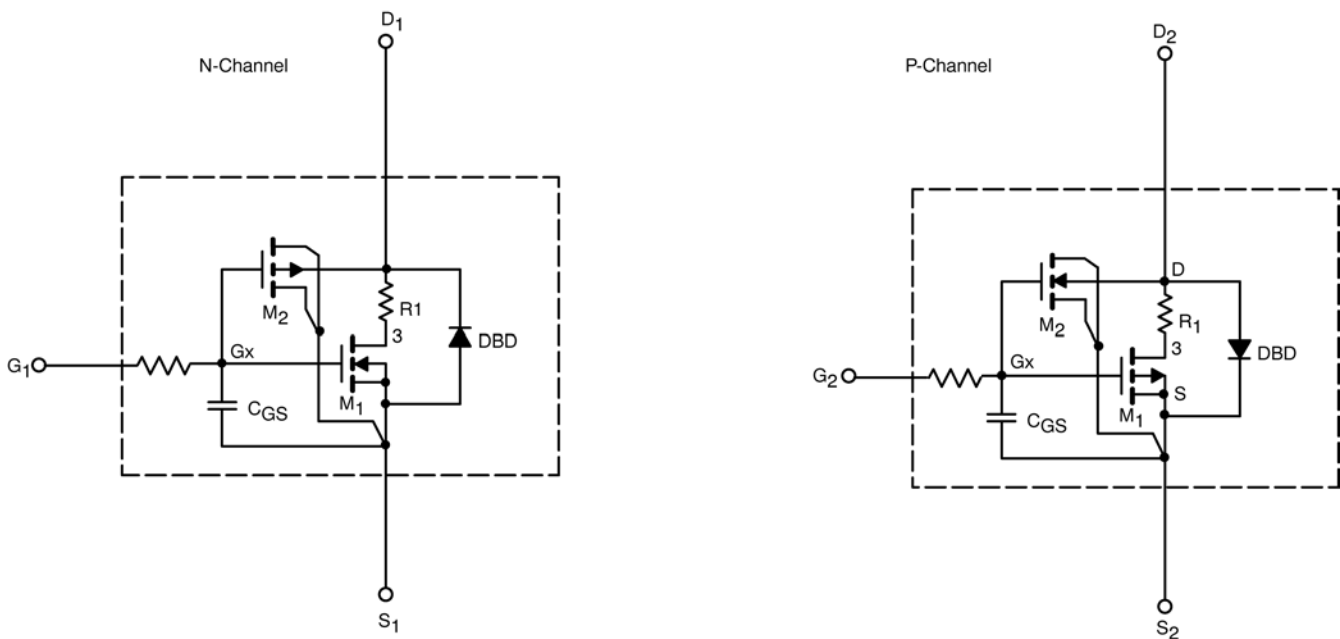

This document is intended as a SPICE modeling guideline and does not constitute a commercial product data sheet. Designers should refer to the appropriate data sheet of the same number for guaranteed specification limits.



SPECIFICATIONS (T _J = 25°C UNLESS OTHERWISE NOTED)						
Parameter	Symbol	Test Condition		Simulated Data	Measured Data	Unit
Static						
Gate Threshold Voltage	V _{GS(th)}	V _{DS} = V _{GS} , I _D = 250 μA	N-Ch	1.2		V
		V _{DS} = V _{GS} , I _D = -250 μA	P-Ch	1.1		
On-State Drain Current ^a	I _{D(on)}	V _{DS} ≤ 5 V, V _{GS} = 4.5 V	N-Ch	46		A
		V _{DS} ≤ -5 V, V _{GS} = -4.5 V	P-Ch	40		
Drain-Source On-State Resistance ^a	r _{DS(on)}	V _{GS} = 4.5 V, I _D = 5 A	N-Ch	0.041	0.043	Ω
		V _{GS} = -4.5 V, I _D = -3.9 A	P-Ch	0.066	0.074	
		V _{GS} = 2.5 V, I _D = 3.9 A	N-Ch	0.072	0.068	
		V _{GS} = -2.5 V, I _D = -2.9 A	P-Ch	0.111	0.128	
Forward Transconductance ^a	g _{fs}	V _{DS} = 10 V, I _D = 5 A	N-Ch	12	10.4	S
		V _{DS} = -10 V, I _D = -3.9 A	P-Ch	12	8.2	
Diode Forward Voltage ^a	V _{SD}	I _S = 2.4 A, V _{GS} = 0 V	N-Ch	0.73	0.80	V
		I _S = -1.5 A, V _{GS} = 0 V	P-Ch	0.80	-0.80	
Dynamic^b						
Input Capacitance	C _{iss}	N-Channel V _{DS} = 10 V, V _{GS} = 0 V, f = 1 MHz P-Channel V _{DS} = -10 V, V _{GS} = 0 V, f = 1 MHz	N-Ch	506	455	pF
			P-Ch	377	300	
Output Capacitance	C _{oss}		N-Ch	80	85	
			P-Ch	92	95	
Reverse Transfer Capacitance	C _{rss}		N-Ch	28	50	
			P-Ch	61	65	
Total Gate Charge	Q _g	V _{DS} = 10V, V _{GS} = 5V, I _D = 4 A	N-Ch	4.2	4.4	nC
		V _{DS} = -10V, V _{GS} = -5V, I _D = -3.9 A	P-Ch	3.6	4.1	
		N-Channel V _{DS} = 10 V, V _{GS} = 4.5V, I _D = 4 A	N-Ch	3.8	3.8	
			P-Ch	3.3	3.9	
Gate-Source Charge	Q _{gs}	P-Channel V _{DS} = -10V, V _{GS} = -4.5V, I _D = -3.9 A	N-Ch	0.9	0.9	
			P-Ch	0.7	0.7	
Gate-Source Charge	Q _{gs}	P-Channel V _{DS} = -10V, V _{GS} = -4.5V, I _D = -3.9 A	N-Ch	0.95	0.95	
			P-Ch	1.25	1.25	

Notes

- a. Pulse test; pulse width ≤ 300 μs, duty cycle ≤ 2%.
- b. Guaranteed by design, not subject to production testing.



SPICE Device Model Si5509DC

Vishay Siliconix

COMPARISON OF MODEL WITH MEASURED DATA ($T_J=25^\circ\text{C}$ UNLESS OTHERWISE NOTED)

N-Channel MOSFET

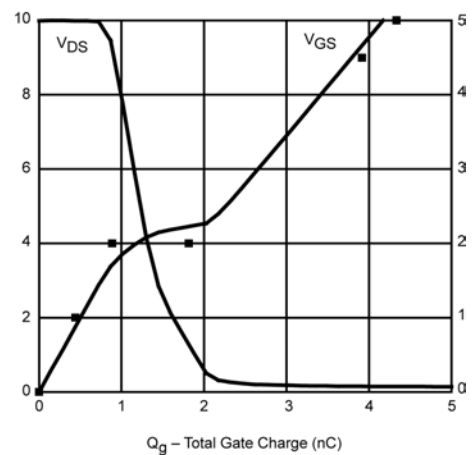
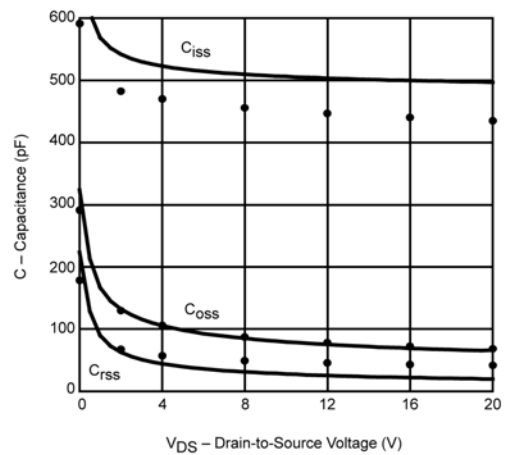
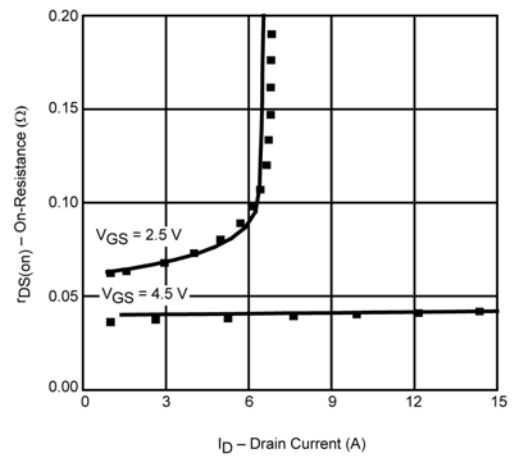
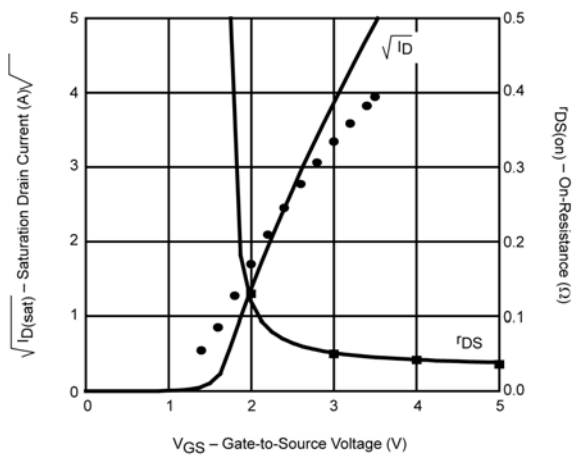
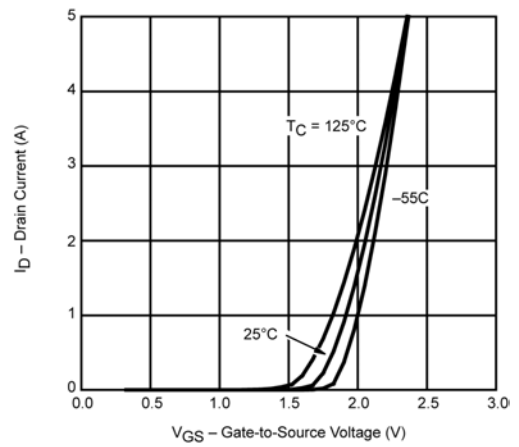
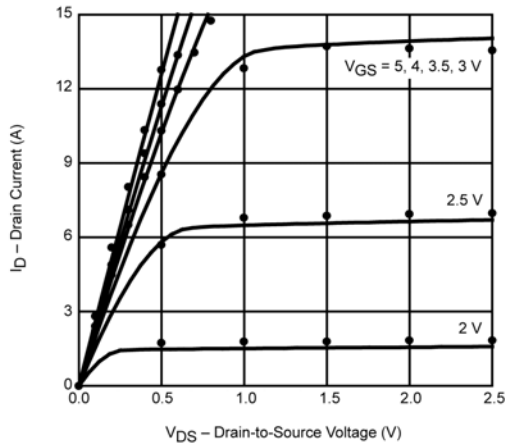

Note: Dots and squares represent measured data.

SPICE Device Model Si5509DC

Vishay Siliconix



P-Channel MOSFET

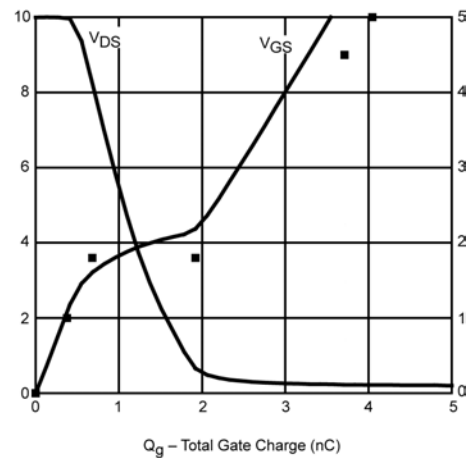
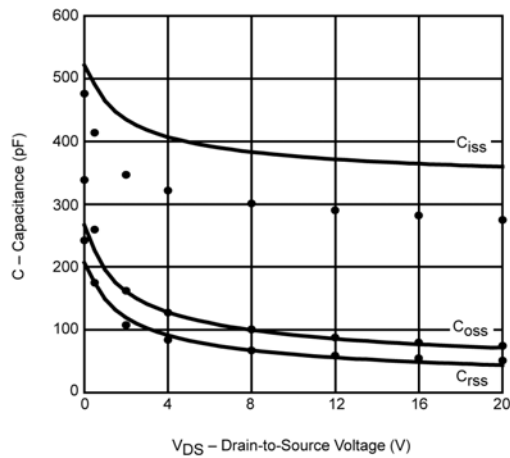
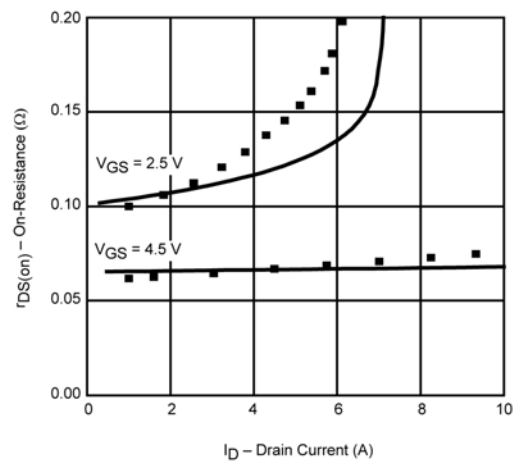
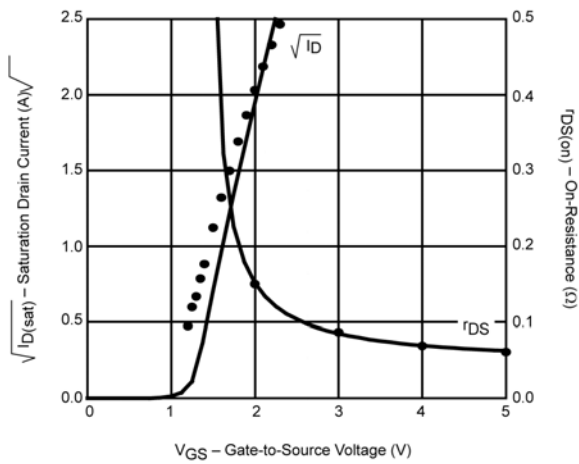
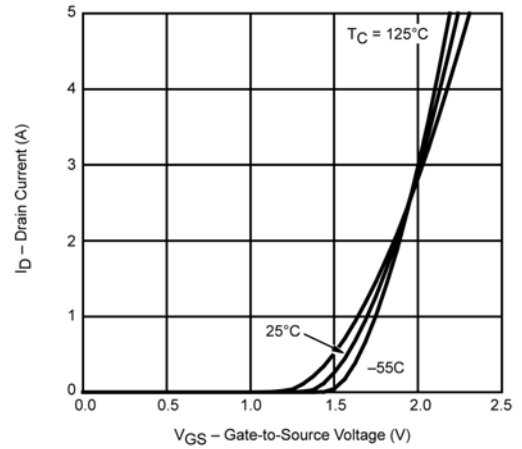
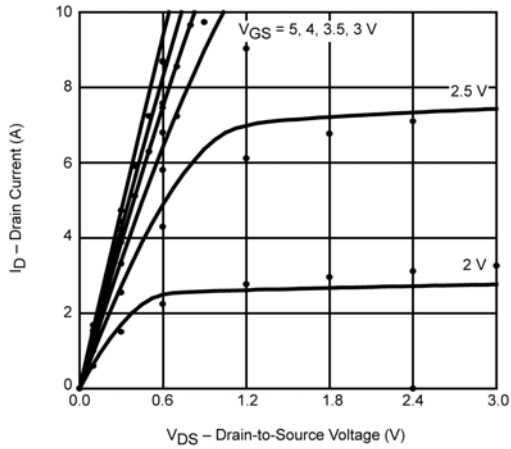

Note: Dots and squares represent measured data.