



N-Channel 1.8-V (G-S) Battery Switch, ESD Protection

PRODUCT SUMMARY		
V_{DS} (V)	$r_{DS(on)}$ (Ω)	I_D (A)
20	0.018 @ $V_{GS} = 4.5$ V	7.5
	0.022 @ $V_{GS} = 2.5$ V	6.5
	0.026 @ $V_{GS} = 1.8$ V	6.0

FEATURES

- TrenchFET® Power MOSFET
- ESD Protected: 4000 V
- Common Drain

APPLICATIONS

- 1-2 Cell Battery Protection Circuitry

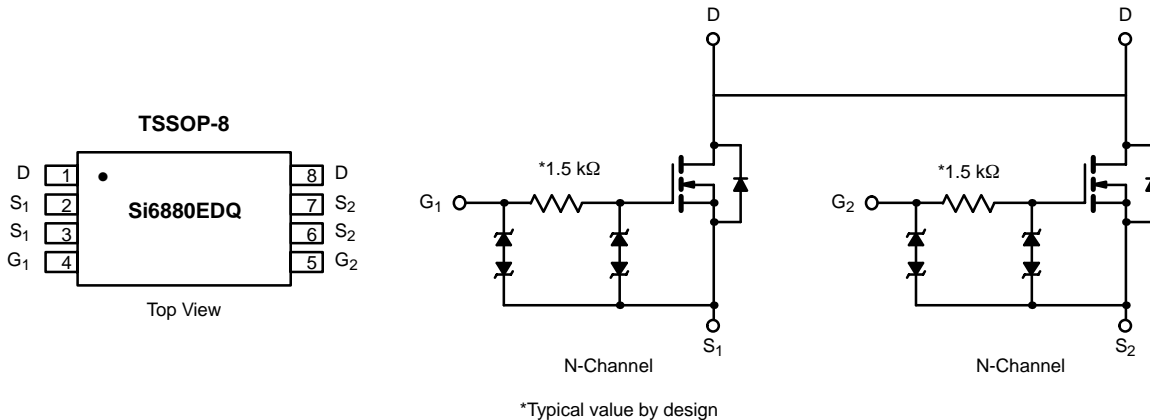

ABSOLUTE MAXIMUM RATINGS ($T_A = 25^\circ\text{C}$ UNLESS OTHERWISE NOTED)					
Parameter		Symbol	10 secs	Steady State	Unit
Drain-Source Voltage		V_{DS}	20		V
Gate-Source Voltage		V_{GS}	± 12		
Continuous Drain Current ($T_J = 150^\circ\text{C}$) ^a	$T_A = 25^\circ\text{C}$	I_D	7.5	6	A
	$T_A = 70^\circ\text{C}$		6	5	
Pulsed Drain Current (10 μs Pulse Width)		I_{DM}	30		
Continuous Source Current (Diode Conduction) ^a		I_S	1.6	1.08	
Maximum Power Dissipation ^a	$T_A = 25^\circ\text{C}$	P_D	1.78	1.19	W
	$T_A = 70^\circ\text{C}$		1.14	0.76	
Operating Junction and Storage Temperature Range		T_J, T_{stg}	-55 to 150		$^\circ\text{C}$

THERMAL RESISTANCE RATINGS					
Parameter		Symbol	Typical	Maximum	Unit
Maximum Junction-to-Ambient ^a	$t \leq 10$ sec.	R_{thJA}	55	70	$^\circ\text{C/W}$
	Steady State		85	105	
Maximum Junction-to-Foot (Drain) ^a	Steady State	R_{thJF}	35	45	

Notes

- Surface Mounted on FR4 Board.
- $t \leq 10$ sec.

SPECIFICATIONS (T_J = 25 °C UNLESS OTHERWISE NOTED)

Parameter	Symbol	Test Conditions	Min	Typ	Max	Unit
Static						
Gate Threshold Voltage	V _{GS(th)}	V _{DS} = V _{GS} , I _D = 250 μA	0.45			V
Gate-Body Leakage	I _{GSS}	V _{DS} = 0 V, V _{GS} = ±4.5 V			±250	nA
		V _{DS} = 0 V, V _{GS} = ±12 V			±10	mA
Zero Gate Voltage Drain Current	I _{DSS}	V _{DS} = 16 V, V _{GS} = 0 V			1	μA
		V _{DS} = 16 V, V _{GS} = 0 V, T _J = 70 °C			25	
On-State Drain Current ^a	I _{D(on)}	V _{DS} ≥ 5 V, V _{GS} = 4.5 V	20			A
Drain-Source On-State Resistance ^a	r _{DS(on)}	V _{GS} = 4.5 V, I _D = 7.5 A		0.015	0.018	Ω
		V _{GS} = 2.5 V, I _D = 6.5 A		0.017	0.022	
		V _{GS} = 1.8 V, I _D = 6.0 A		0.020	0.026	
Forward Transconductance ^a	g _{fs}	V _{DS} = 10 V, I _D = 7.5 A		39		S
Diode Forward Voltage ^a	V _{SD}	I _S = 1.6 A, V _{GS} = 0 V		0.65	1.1	V
Dynamic^b						
Total Gate Charge	Q _g	V _{DS} = 10 V, V _{GS} = 4.5 V, I _D = 7.5 A		27	40	nC
Gate-Source Charge	Q _{gs}		3.0			
Gate-Drain Charge	Q _{gd}		5.5			
Turn-On Delay Time	t _{d(on)}	V _{DD} = 10 V, R _L = 10 Ω I _D ≅ 1 A, V _{GEN} = 4.5 V, R _G = 6 Ω		1.5	2.3	μs
Rise Time	t _r			800	1200	
Turn-Off Delay Time	t _{d(off)}			6	10	
Fall Time	t _f			5.5	10	

Notes

- a. Pulse test; pulse width ≤ 300 μs, duty cycle ≤ 2%.
b. Guaranteed by design, not subject to production testing.

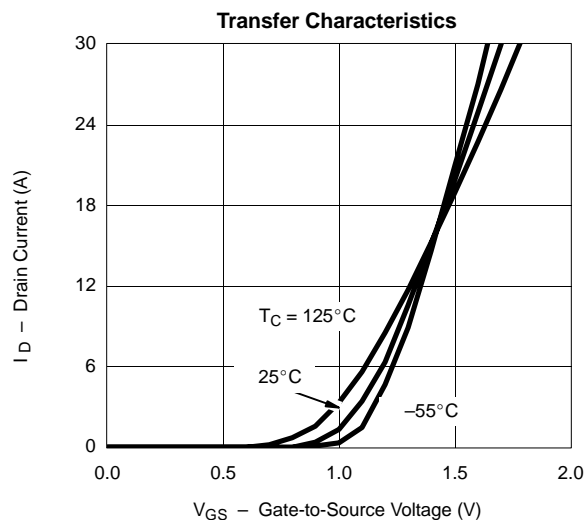
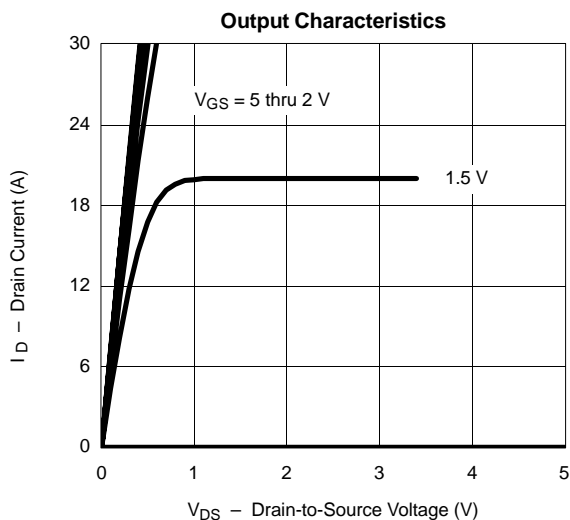
TYPICAL CHARACTERISTICS (25 °C UNLESS NOTED)



TYPICAL CHARACTERISTICS (25°C UNLESS NOTED)

On-Resistance vs. Drain Current

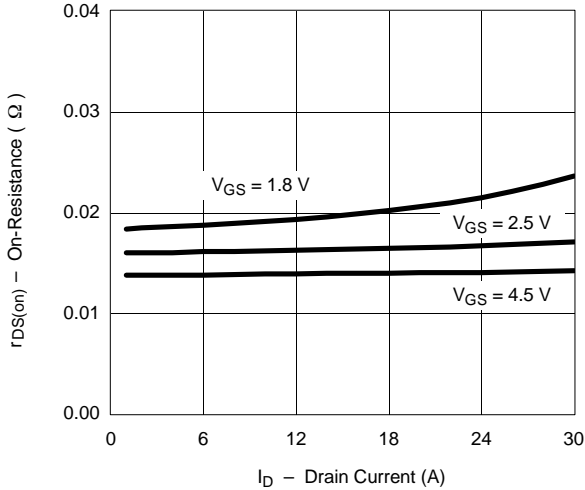

Gate Charge

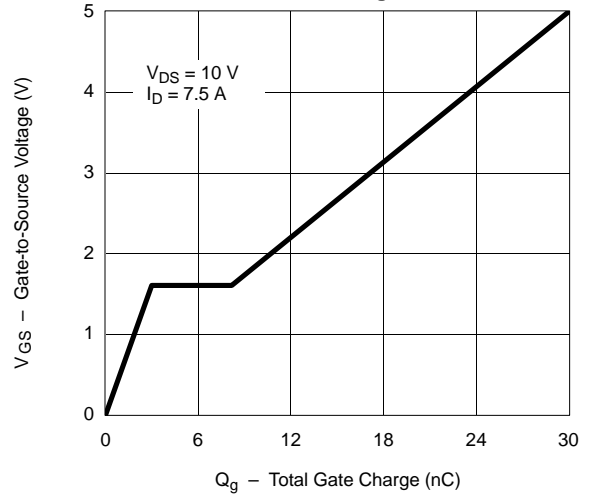

On-Resistance vs. Junction Temperature

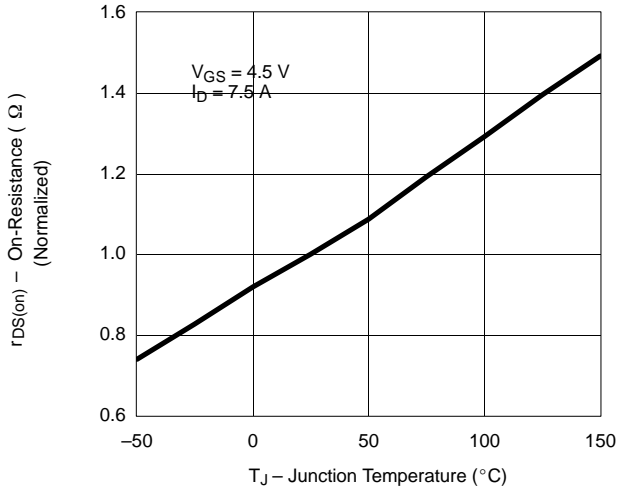

Source-Drain Diode Forward Voltage

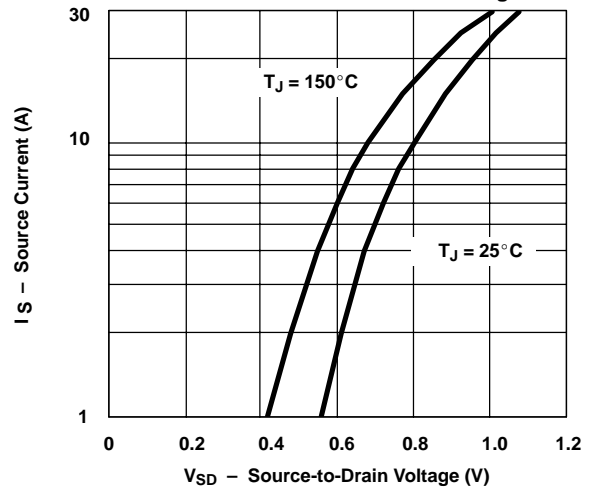

On-Resistance vs. Gate-to-Source Voltage

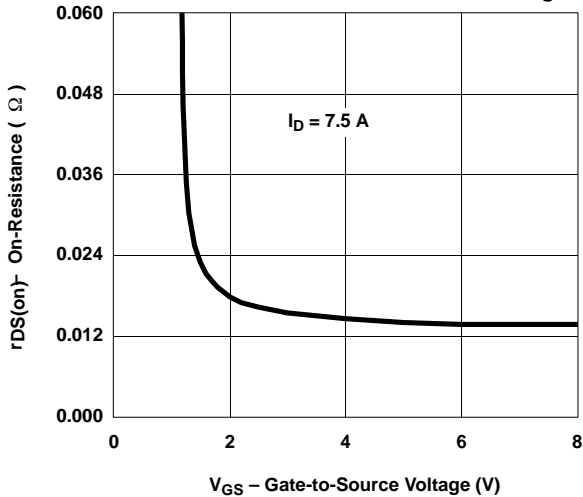

Threshold Voltage

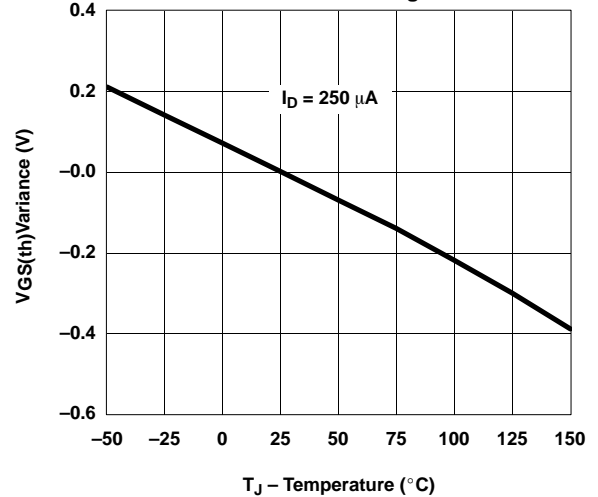

TYPICAL CHARACTERISTICS (25 °C UNLESS NOTED)

