

# SK 20 GD 123



**SEMITOP<sup>®</sup> 3**

## IGBT Module

### SK 20 GD 123

Preliminary Data

#### Features

- Compact design
- One screw mounting
- Heat transfer and isolation through direct copper bonded aluminium oxide ceramic (DCB)
- N channel, homogeneous Silicon structure (NPT-Non punchthrough IGBT)
- High short circuit capability
- Low tail current with low temperature dependence
- UL recognized, file no. E 63532

#### Typical Applications

- Switching ( not for linear use )
- Inverter
- Switched mode power supplies
- UPS

Absolute Maximum Ratings		$T_s = 25\text{ }^\circ\text{C}$ , unless otherwise specified	
Symbol	Conditions	Values	Units
<b>IGBT</b>			
$V_{CES}$		1200	V
$V_{GES}$		$\pm 20$	V
$I_C$	$T_s = 25\text{ (80) }^\circ\text{C}$ ;	23 (15)	A
$I_{CM}$	$t_p < 1\text{ ms}$ ; $T_s = 25\text{ (80) }^\circ\text{C}$ ;	46 (30)	A
$T_j$		- 40 ... + 150	$^\circ\text{C}$
<b>Inverse/Freewheeling CAL diode</b>			
$I_F$	$T_s = 25\text{ (80) }^\circ\text{C}$ ;	24 (17)	A
$I_{FM} = -I_{CM}$	$t_p < 1\text{ ms}$ ; $T_s = 25\text{ (80) }^\circ\text{C}$ ;	48 (34)	A
$T_j$		- 40 ... + 150	$^\circ\text{C}$
$T_{stg}$		- 40 ... + 125	$^\circ\text{C}$
$T_{sol}$	Terminals, 10 s	260	$^\circ\text{C}$
$V_{isol}$	AC 50 Hz, r.m.s. 1 min. / 1 s	2500 / 3000	V

Characteristics		$T_s = 25\text{ }^\circ\text{C}$ , unless otherwise specified			
Symbol	Conditions	min.	typ.	max.	Units
<b>IGBT</b>					
$V_{CE(sat)}$	$I_C = 15\text{ A}$ , $T_j = 25\text{ (125) }^\circ\text{C}$		2,5 (3,1)	3 (3,7)	V
$V_{GE(th)}$	$V_{CE} = V_{GE}$ ; $I_C = 0,0006\text{ A}$	4,5	5,5	6,5	V
$C_{res}$	$V_{CE} = 25\text{ V}$ ; $V_{GE} = 0\text{ V}$ ; 1 MHz		1		nF
$R_{th(j-s)}$	per IGBT			1,4	K/W
	per module				K/W
$t_{d(on)}$	under following conditions: $V_{CC} = 600\text{ V}$ , $V_{GE} = \pm 15\text{ V}$		35		ns
$t_r$	$I_C = 15\text{ A}$ , $T_j = 125\text{ }^\circ\text{C}$		45		ns
$t_{d(off)}$	$R_{Gon} = R_{Goff} = 40\text{ }\Omega$		250		ns
$t_f$			70		ns
$E_{on} + E_{off}$	Inductive load		3,8		mJ
<b>Inverse/Freewheeling CAL diode</b>					
$V_F = V_{EC}$	$I_F = 15\text{ A}$ ; $T_j = 25\text{ (125) }^\circ\text{C}$		2 (1,8)	2,5 (2,3)	V
$V_{(TO)}$	$T_j = (125)\text{ }^\circ\text{C}$		(1)	(1,2)	V
$r_T$	$T_j = (125)\text{ }^\circ\text{C}$		(53)	(73)	m $\Omega$
$R_{th(j-s)}$				1,7	K/W
$I_{RRM}$	under following conditions: $I_F = 15\text{ A}$ ; $V_R = 600\text{ V}$		16		A
$Q_{rr}$	$di_F/dt = -200\text{ A}/\mu\text{s}$		2,7		$\mu\text{C}$
$E_{off}$	$V_{GE} = 0\text{ V}$ ; $T_j = 125\text{ }^\circ\text{C}$		0,6		mJ
<b>Mechanical data</b>					
M1	mounting torque			2,5	Nm
w			30		g
Case	SEMITOP <sup>®</sup> 3		T 12		

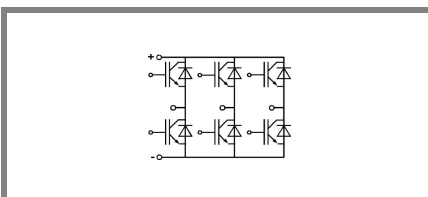

GD

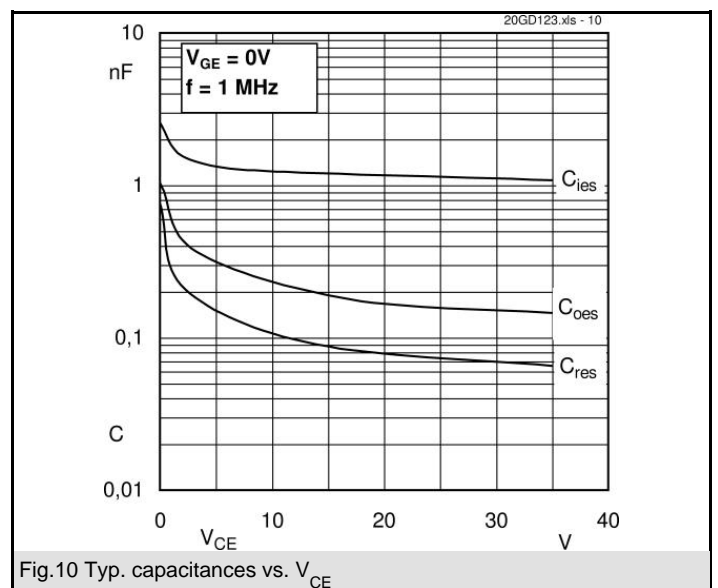
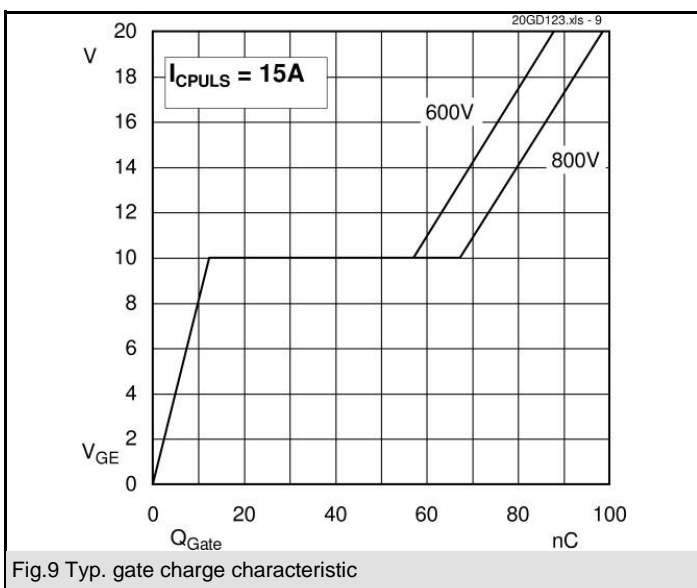
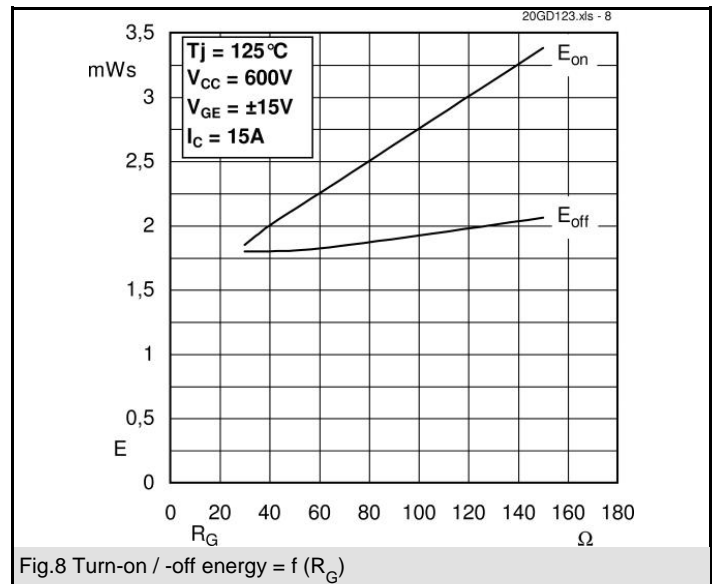
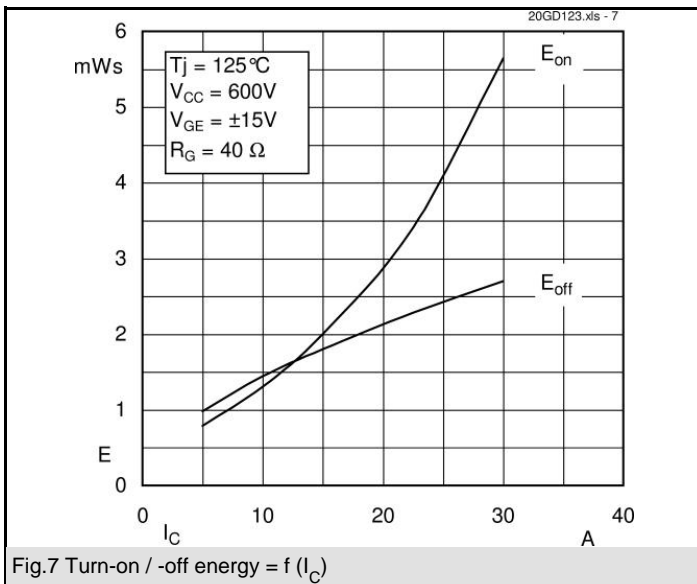
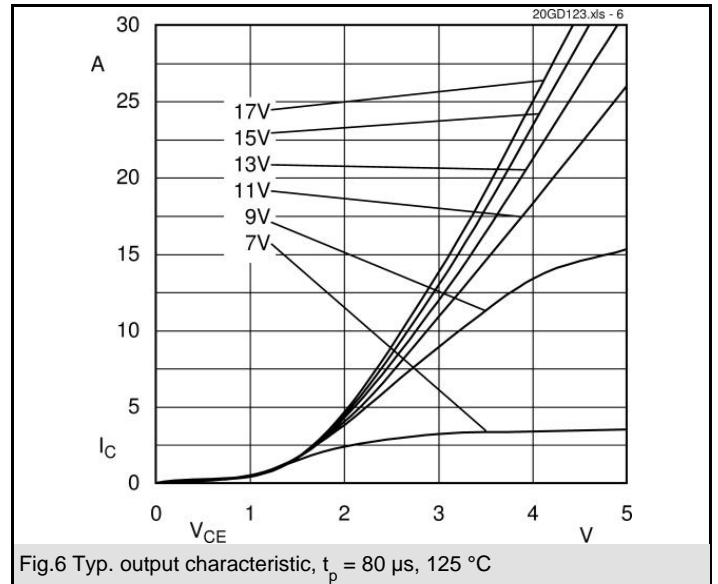
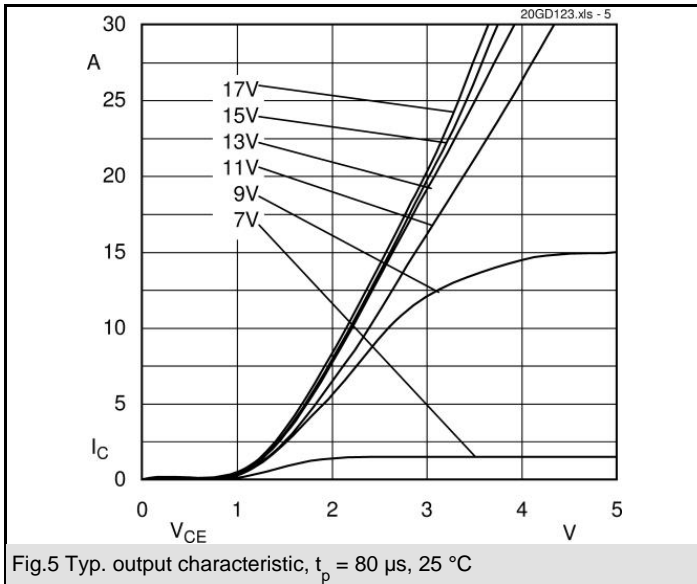

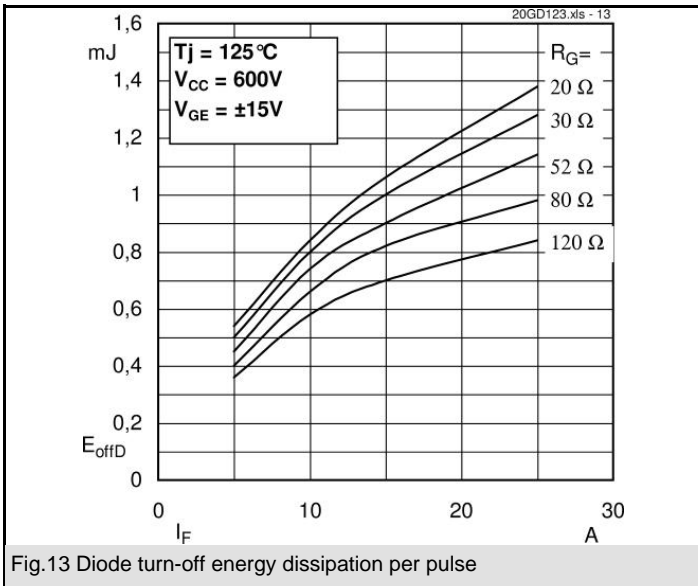
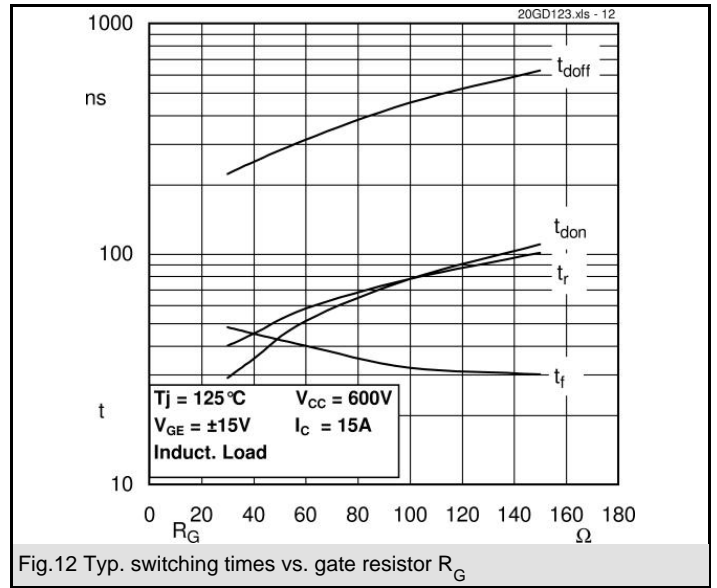
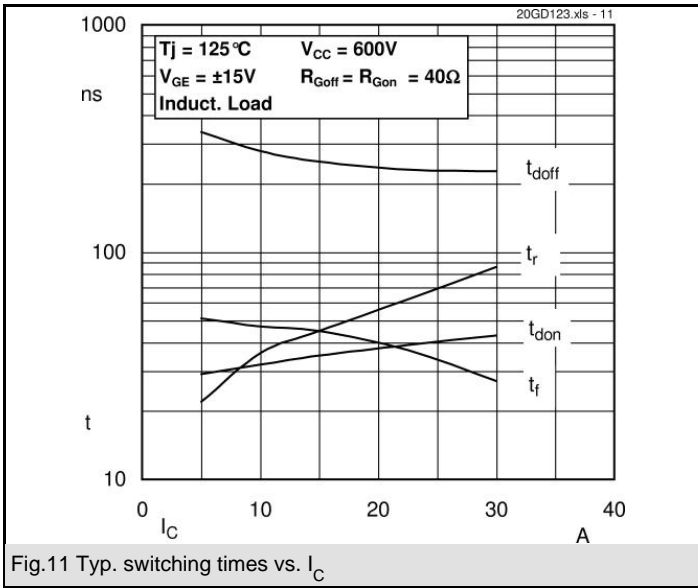

# SK 20 GD 123

UL Recognized  
File no. E 63532

Dimensions in mm

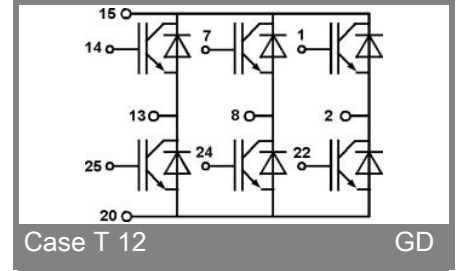
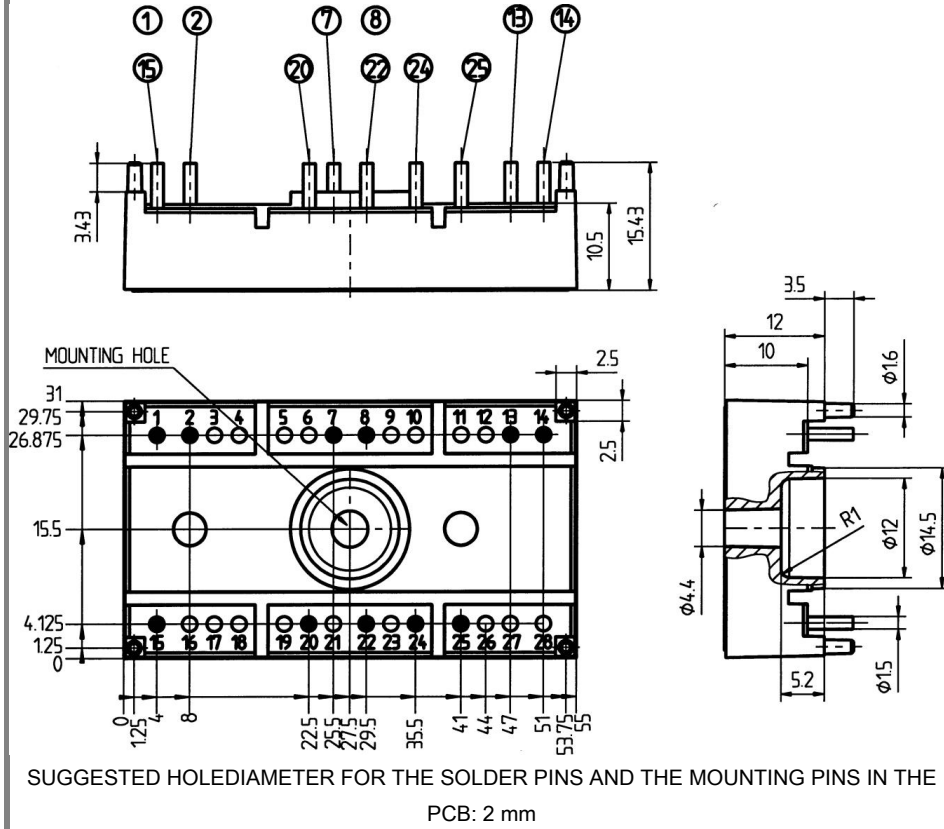

Case T 12

This is an electrostatic discharge sensitive device (ESDS), international standard IEC 60747-1, Chapter IX.

This technical information specifies semiconductor devices but promises no characteristics. No warranty or guarantee expressed or implied is made regarding delivery, performance or suitability.