

NON-ISOLATED DC/DC CONVERTERS

4.5 Vdc - 14 Vdc Input

0.75 Vdc - 5.0 Vdc/3 A Output

bel
POWER PRODUCTS

SRBA-03E1Ax

RoHS Compliant

Rev.A

- Non-Isolated
- Fixed Frequency
- High Efficiency
- High Power Density
- Under-voltage Lockout (UVLO)
- OCP/SCP
- Remote On/Off
- Wide Trim Range
- Wide Input Range
- Active Low/Active High (Option)



Description

The Bel SRBA-03E1Ax modules are a series of non-isolated dc/dc converters that deliver up to 3 A of output current with full load efficiency of 93% at 5.0 Vdc output. These modules provide precisely regulated voltage programmable via external resistor from 0.75 Vdc to 5.0 Vdc over a wide range of input voltage. Their open-frame construction and small footprint enable designers to develop cost and space-efficient solutions. Standard features include remote On/Off, programmable output voltage and over current protection.

Part Selection

Output Voltage	Input Voltage	Max. Output Current	Max. Output Power	Typical Efficiency at 5.0V	Model Number Active High	Model Number Active Low
0.75 V - 5.0 V ¹	4.5 V - 14 V	3 A	15 W	93%	SRBA-03A1A0	SRBA-03A1AL

- Notes:**
1. These modules use a buck topology, so the output voltages must be 0.5 V less than the input voltage.
 2. Add "G" to the end of the Model Number to indicate Tray Packaging.
 3. All part numbers above indicate RoHS 6. Change the second letter "R" to "7" for RoHS 5 part numbers.

Absolute Maximum Ratings

Parameter	Min	Typ	Max	Notes
Input Voltage (continuous)	-0.3 V	-	15 V	
Output Enable Terminal Voltage	-0.3 V	-	15 V	
Ambient Temperature	-40 °C	-	85 °C	
Storage Temperature	-55 °C	-	125 °C	

Note: All specifications are typical at 25 °C unless otherwise stated.

Input Specifications

Parameter	Min	Typ	Max	Notes
Input Voltage				
Vo set=5 V	7.0 V	12 V	14 V	
Vo set≤3.3 V	4.5 V	12 V	14 V	
Input Current (full load)				
Vo=5.0 V	-	1.35 A	3.70 A	
Vo=3.3 V	-	1.00 A	2.50 A	
Vo=0.75 V	-	0.25 A	0.65 A	
Input Current (no load)				
Vo=5.0 V	-	65 mA	80 mA	
Vo=3.3 V	-	50 mA	60 mA	
Vo=0.75 V	-	15 mA	20 mA	
Remote Off Input Current	-	3 mA	6 mA	

NON-ISOLATED DC/DC CONVERTERS

4.5 Vdc - 14 Vdc Input

0.75 Vdc - 5.0 Vdc/3 A Output



Input Specifications (continued)

Parameter	Min	Typ	Max	Notes
Input Reflected Ripple Current (pk-pk) Vo=5.0 V Vo=3.3 V Vo=0.75 V	- - -	150 mA 100 mA 35 mA	200 mA 150 mA 45 mA	Tested with simulated source impedance of 1uH, 5 Hz to 20 MHz and two 100 uF/25 V external input Tantalum capacitors.
Input Reflected Ripple Current (rms) Vo=5.0 V Vo=3.3 V Vo=0.75 V	- - -	30 mA 20 mA 8 mA	40 mA 35 mA 15 mA	
I ² t Inrush Current Transient	-	0.01 A ² s	0.02 A ² s	
Turn-on Voltage Threshold Vo set=5 V Vo set≤3.3 V	- -	5.5 V 4.3 V	6.5 V 4.5 V	
Turn-off Voltage Threshold Vo set=5 V Vo set≤3.3 V	3.8 V 3.8 V	5.5 V 4.0 V	6.0 V 4.3 V	

Output Specifications

Parameter	Min	Typ	Max	Notes	
Output Voltage Set Point	-2%Vo,set	-	2%Vo,set	Vin=12 V, Io=Iomax	
Output Voltage Set Point	-3.5%Vo,set	-	2.5%Vo,set	Over all operating input voltage, resistive load, and temperature conditions	
Load Regulation	0.4%Vo,set	0.2%Vo,set	0.4%Vo,set	Io=Iomin to Iomax	
Line Regulation	0.4%Vo,set	0.3%Vo,set	0.4%Vo,set	Vin=Vinmin to Vinmax	
Regulation Over Temperature (-40 °C to +85 °C)	-	0.5%Vo,set	-		
Output Current	0 A	-	3 A		
Current Limit Threshold	5 A	-	9.5 A		
Short Circuit Surge Transient	-	0.1A ² s	0.2 A ² s		
Ripple and Noise (pk-pk) Vo=5.0 V Vo=3.3 V Vo=0.75 V	- - -	100 mV 80 mV 55 mV	120 mV 100 mV 80 mV	Test conditions: 0-20 MHz BW, with external 10 uF/10 V Tantalum capacitor and 1uF/10V ceramic capacitor at the output.	
Ripple and Noise (rms) Vo=5.0 V Vo=3.3 V Vo=0.75 V	- - -	30 mV 20 mV 15 mV	40 mV 30 mV 20 mV		
Ripple and Noise (pk-pk) Vo=5.0 V Vo=3.3 V Vo=0.75 V	- - -	60 mV 40 mV 20 mV	80 mV 50 mV 30 mV	Test conditions: 0-20 MHz BW, with external 10 uF/10 V Tantalum capacitor 1uF/10V ceramic capacitor and two 22 uF/10 V ceramic capacitors at the output.	
Ripple and Noise (rms) Vo=5.0 V Vo=3.3 V Vo=0.75 V	- - -	15 mV 12 mV 5 mV	25 mV 20 mV 10 mV		
Turn on Time	-	8 mS	12 mS		
Overshoot at Turn on	-	0%	3%		
Output Capacitance	0 uF	-	1200 uF		
Transient Response					
50% ~ 100% Max Load	All	-	150 mV	200 mV	Test conditions: di/dt = 2.5 A/uS, Vin=12 V, and with external 10 uF/10 V Tantalum capacitor and 1uF/10 V ceramic capacitor at the output.
Settling Time		-	25 uS	40 uS	
100% ~ 50% Max Load		-	150 mV	200 mV	
Settling Time		-	25 uS	40 uS	

Note: All specifications are typical at nominal input (Vin=12 V), full load at 25 °C unless otherwise stated.

NON-ISOLATED DC/DC CONVERTERS

4.5 Vdc - 14 Vdc Input

0.75 Vdc - 5.0 Vdc/3 A Output



General Specifications

Parameter	Min	Typ	Max	Notes
Efficiency Vo=5.0 V Vo=3.3 V Vo=0.75 V	90% 88% 77%	93% 91% 80%	- - -	Measured at Vin=12 V, full load
Switching Frequency	200 kHz	230 kHz	250 kHz	
Output Voltage Trim Range (Wide Trim)	0.7525 V	-	5 V	
MTBF	6,350,000 hours			Calculated Per Bell Core SR-332 (Io = 80% load; Ta = 25 °C)
Dimensions (Surface Mount) Inches (L x W x H) Millimeters (L x W x H)	0.8 x 0.45 x 0.251 20.32 x 11.42 x 6.38			
Weight	-	2.5 g	-	

Note: All specifications are typical at 25 °C unless otherwise stated.

Control Specifications

Parameter	Min	Typ	Max	Notes
Remote On/Off				
Signal Low (Unit Off)	-0.3 V	-	0.4 V	Remote On/Off pin open, Unit on.
Signal High (Unit On)	2.5 V	-	14 V	
Signal Low (Unit On)	-0.3 V	-	0.4 V	
Signal High (Unit Off)	2.5 V	-	14 V	

Output Trim Equations

Equation for calculating the trim resistor (in kΩ) given the desired adjusted voltage (Vadj) is shown below. The Trim Up resistor should be connected between the Trim pin and Ground.

$$R_{trim} = \frac{10.507}{V_{adj} - 0.7525} - 1$$

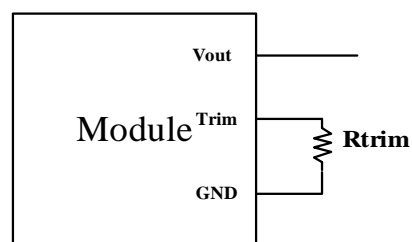

Equation for calculating the trim voltage (in V) given the desired adjusted voltage (Vadj) is shown below. The Trim Up voltage should be connected between the Trim pin and Ground.

$$V_{trim} = 0.7 - 0.0667 \times (V_{adj} - 0.7525)$$

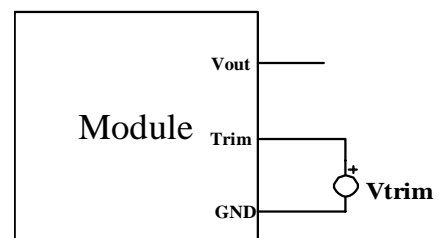

NON-ISOLATED DC/DC CONVERTERS

4.5 Vdc - 14 Vdc Input

0.75 Vdc - 5.0 Vdc/3 A Output



Efficiency Data

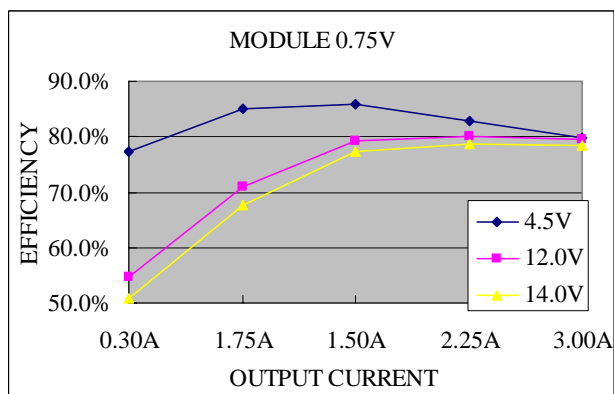
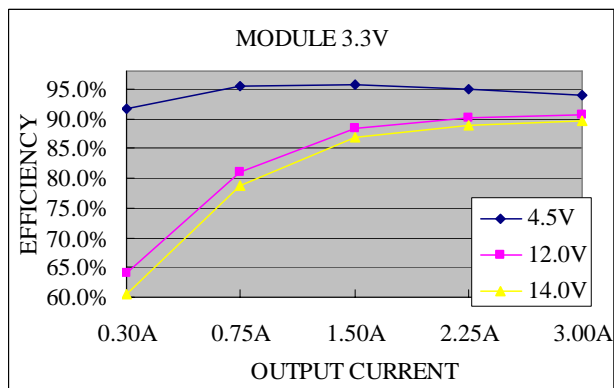
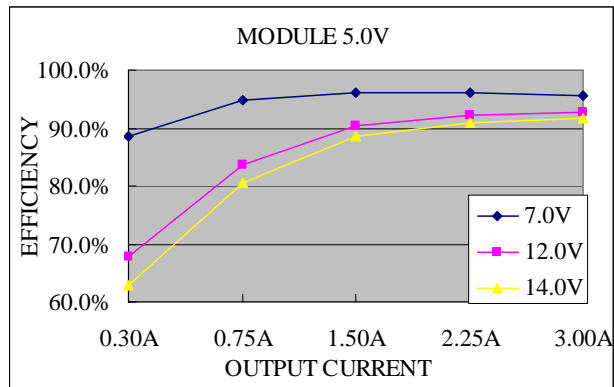

NON-ISOLATED DC/DC CONVERTERS

4.5 Vdc - 14 Vdc Input

0.75 Vdc - 5.0 Vdc/3 A Output



Thermal Derating Curves

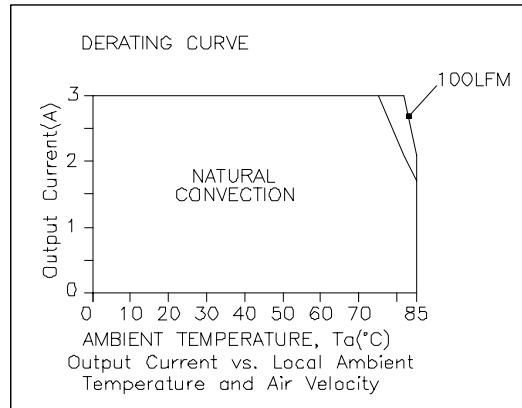

Vin=12 V, Vo=5.0 V

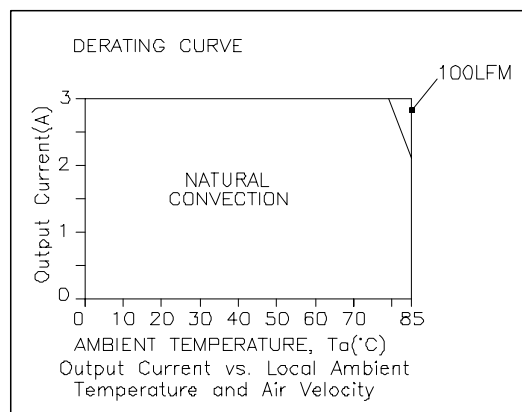

Vin=12 V, Vo=3.3 V

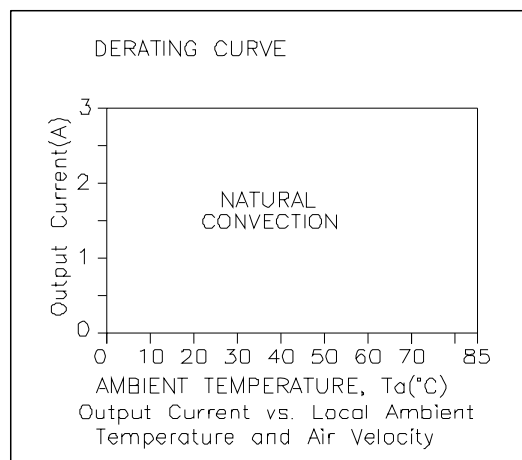

Vin=12 V, Vo=0.75 V

NON-ISOLATED DC/DC CONVERTERS

4.5 Vdc - 14 Vdc Input

0.75 Vdc - 5.0 Vdc/3 A Output



Ripple and Noise Waveforms

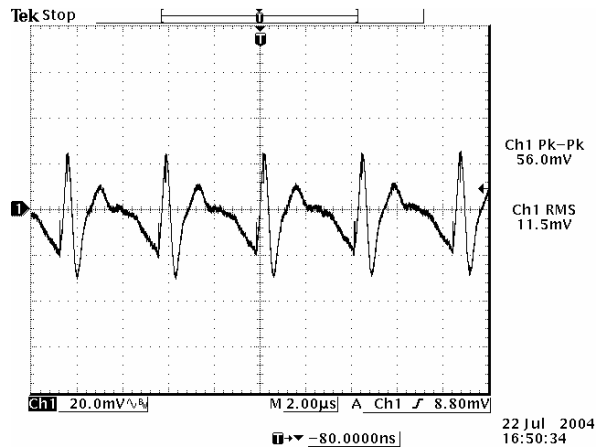

12 Vdc input, 0.75 Vdc output

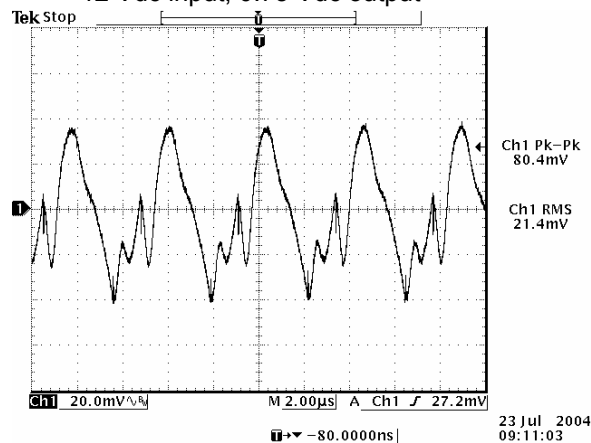

12 Vdc input, 3.3 Vdc output

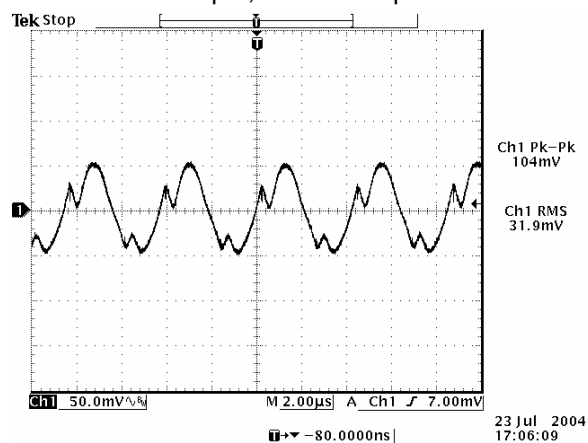

12 Vdc input, 5.0 Vdc output

Note: Ripple and noise at full load, 0-20 MHz BW, with 10 uF/10 V tantalum cap and 1 uF/10 V ceramic cap at the output, and $T_a=25$ deg C.

NON-ISOLATED DC/DC CONVERTERS

4.5 Vdc - 14 Vdc Input

0.75 Vdc - 5.0 Vdc/3 A Output



Transient Response Waveforms

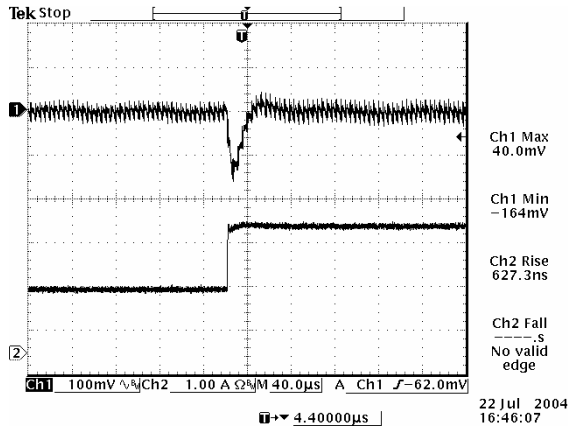

Transients 50% to 100% load 0.75 Vdc output

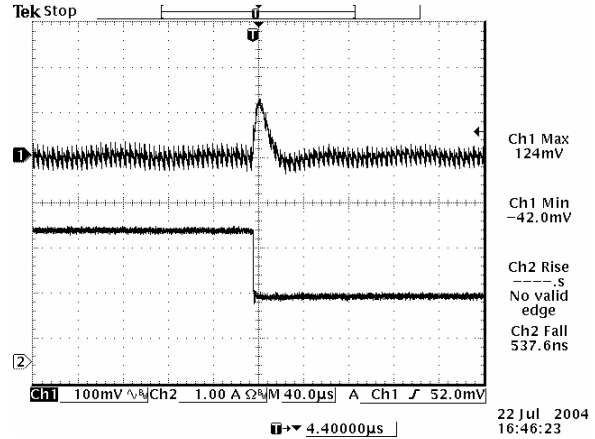

Transients 100% to 50% load 0.75 Vdc output

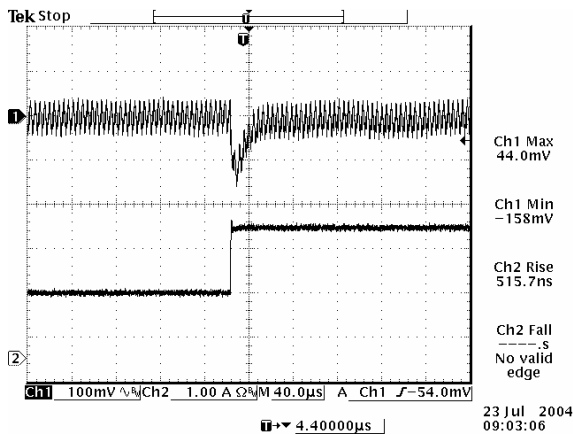

Transients 50% to 100% load 3.3 Vdc output

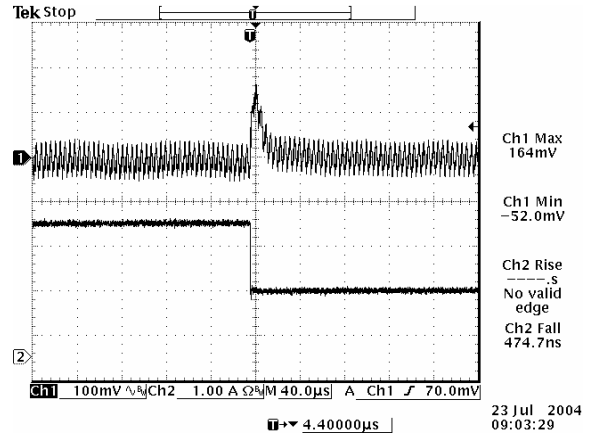

Transients 100% to 50% load 3.3 Vdc output

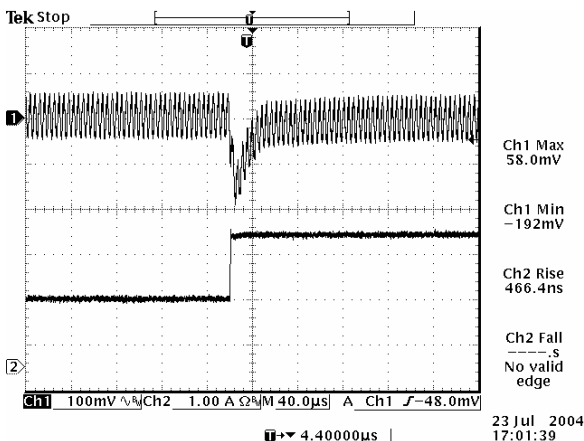

Transients 50% to 100% load 5.0 Vdc output

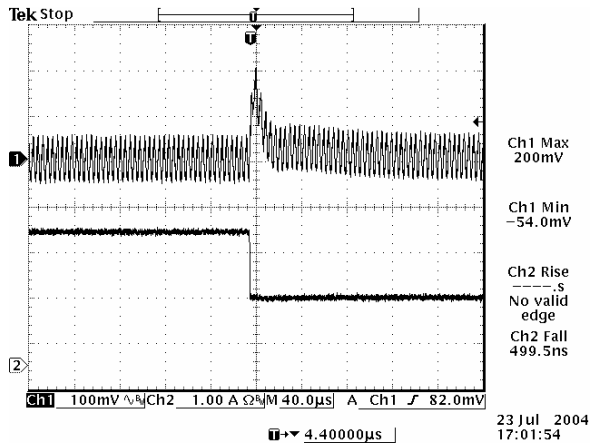

Transients 100% to 50% load 5.0 Vdc output

Note: Transient response at 12 Vdc input, $di/dt=2.5$ A/ μ S, with 10 μ F/10 V tantalum cap and 1 μ F/10 V ceramic cap at the output, $T_a=25$ deg C.

NON-ISOLATED DC/DC CONVERTERS

4.5 Vdc - 14 Vdc Input

0.75 Vdc - 5.0 Vdc/3 A Output



Mechanical Outline

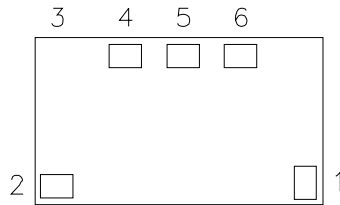
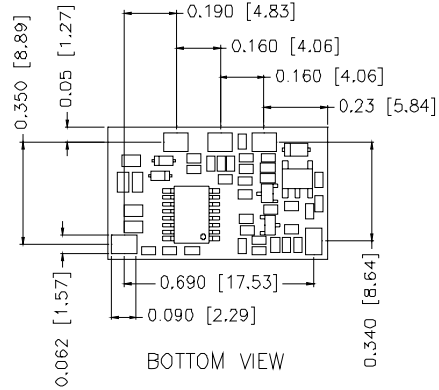
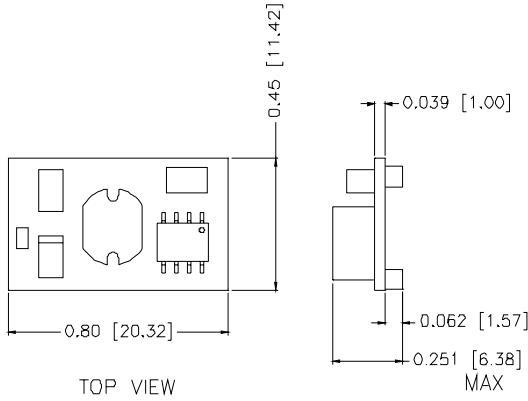

RECOMMENDED PAD LAYOUT

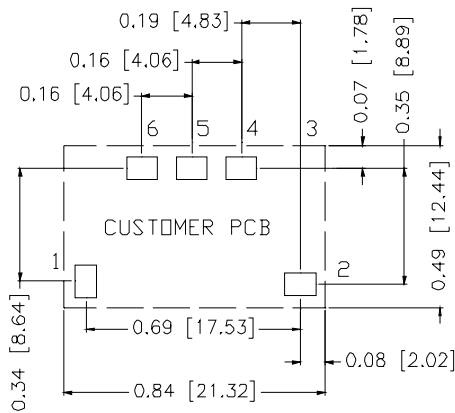

Pin Connections

Pin	Function
1	Remote On/Off
2	Vin
3	N/A
4	Ground
5	Trim
6	Vout

PAD SIZE:

MIN: 0.12" * 0.095" (3.05mm*2.41mm)

MAX: 0.135" * 0.11" (3.43mm*2.79mm)

RoHS Compliance

Complies with the European Directive 2002/95/EC, calling for the elimination of lead and other hazardous substances from electronic products.



©2007 Bel Fuse Inc. Specifications subject to change without notice. 011207

CORPORATE

Bel Fuse Inc.
206 Van Vorst Street
Jersey City, NJ 07302
Tel 201-432-0463
Fax 201-432-9542
www.belfuse.com

FAR EAST

Bel Fuse Ltd.
8F/ 8 Luk Hop Street
San Po Kong
Kowloon, Hong Kong
Tel 852-2328-5515
Fax 852-2352-3706
www.belfuse.com

EUROPE

Bel Fuse Europe Ltd.
Preston Technology Management Centre
Marsh Lane, Suite G7, Preston
Lancashire, PR1 8UD, U.K.
Tel 44-1772-556601
Fax 44-1772-888366
www.belfuse.com