



Integrated
Circuit
Systems, Inc.

PRELIMINARY

ICS85222-02 1-TO-2 LVCMOS / LVTTTL-TO- DIFFERENTIAL HSTL TRANSLATOR

GENERAL DESCRIPTION



The ICS85222-02 is a 1-to-2 LVCMOS / LVTTTL-to-Differential HSTL translator and a member of the HiPerClocks™ family of High Performance Clock Solutions from ICS. The ICS85222-02 has one single ended clock input. The single ended clock input accepts LVCMOS or LVTTTL input levels and translates them to HSTL levels. The small outline 8-pin SOIC package makes this device ideal for applications where space, high performance and low power are important.

FEATURES

- Two differential HSTL outputs
- One LVCMOS/LVTTTL clock input
- CLK input can accept the following input levels: LVCMOS or LVTTTL
- Maximum output frequency: 350MHz
- Part-to-part skew: TBD
- Propagation delay: 1ns (typical)
- V_{OH} : 1.4V (maximum)
- Full 3.3V operating supply voltage
- 0°C to 70°C ambient operating temperature
- Industrial temperature information available upon request
- Available in both standard and lead-free RoHS compliant packages

BLOCK DIAGRAM

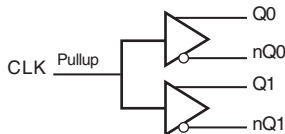

PIN ASSIGNMENT

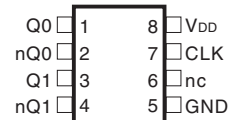

ICS85222-02

8-Lead SOIC

3.90mm x 4.92mm x 1.37mm body package

M Package

Top View

The Preliminary Information presented herein represents a product in prototyping or pre-production. The noted characteristics are based on initial product characterization. Integrated Circuit Systems, Incorporated (ICS) reserves the right to change any circuitry or specifications without notice.



TABLE 1. PIN DESCRIPTIONS

Number	Name	Type		Description
1, 2	Q0, nQ0	Output		Differential output pair. HSTL interface levels.
3, 4	Q1, nQ1	Output		Differential output pair. HSTL interface levels.
5	GND	Power		Power supply ground.
6	CLK	Input	Pullup	LVCMOS / LVTTTL clock input.
7	nc	Unused		No connect.
8	V _{DD}	Power		Positive supply pin.

NOTE: *Pullup* refers to internal input resistors. See Table 2, Pin Characteristics, for typical values.

NOTE: Unused output pairs must be terminated.

TABLE 2. PIN CHARACTERISTICS

Symbol	Parameter	Test Conditions	Minimum	Typical	Maximum	Units
C _{IN}	Input Capacitance			4		pF
R _{PULLUP}	Input Pullup Resistor			51		kΩ



ABSOLUTE MAXIMUM RATINGS

Supply Voltage, V_{DD}	4.6V
Inputs, V_I	-0.5V to $V_{DD} + 0.5V$
Outputs, I_O	
Continuous Current	50mA
Surge Current	100mA
Package Thermal Impedance, θ_{JA}	112.7°C/W (0 lfpm)
Storage Temperature, T_{STG}	-65°C to 150°C

NOTE: Stresses beyond those listed under Absolute Maximum Ratings may cause permanent damage to the device. These ratings are stress specifications only. Functional operation of product at these conditions or any conditions beyond those listed in the *DC Characteristics* or *AC Characteristics* is not implied. Exposure to absolute maximum rating conditions for extended periods may affect product reliability.

TABLE 3A. POWER SUPPLY DC CHARACTERISTICS, $V_{DD} = 3.3V \pm 5\%$, $T_A = 0^\circ C$ TO $70^\circ C$

Symbol	Parameter	Test Conditions	Minimum	Typical	Maximum	Units
V_{DD}	Positive Supply Voltage		3.135	3.3	3.465	V
I_{DD}	Power Supply Current			90		mA

TABLE 3B. LVCMOS / LVTTTL DC CHARACTERISTICS, $V_{DD} = 3.3V \pm 5\%$, $T_A = 0^\circ C$ TO $70^\circ C$

Symbol	Parameter	Test Conditions	Minimum	Typical	Maximum	Units
V_{IH}	Input High Voltage		2		$V_{DD} + 0.3$	V
V_{IL}	Input Low Voltage		-0.3		0.8	V
I_{IH}	Input High Current	CLK $V_{DD} = V_{IN} = 3.465V$			5	μA
I_{IL}	Input Low Current	CLK $V_{DD} = 3.465, V_{IN} = 0V$	-150			μA

TABLE 3C. HSTL DC CHARACTERISTICS, $V_{DD} = 3.3V \pm 5\%$, $T_A = 0^\circ C$ TO $70^\circ C$

Symbol	Parameter	Test Conditions	Minimum	Typical	Maximum	Units
V_{OH}	Output High Voltage; NOTE 1		1		1.4	V
V_{OL}	Output Low Voltage; NOTE 1		0		0.4	V
V_{SWING}	Peak-to-Peak Output Voltage Swing		0.6		1.4	V

NOTE 1: Outputs terminated with 50Ω to GND.

TABLE 4. AC CHARACTERISTICS, $V_{DD} = 3.3V \pm 5\%$, $T_A = 0^\circ C$ TO $70^\circ C$

Symbol	Parameter	Test Conditions	Minimum	Typical	Maximum	Units
f_{MAX}	Output Frequency				350	MHz
t_{PD}	Propagation Delay; NOTE 1			1.0		ns
$t_{sk(pp)}$	Part-to-Part Skew; NOTE 2, 3			TBD		ps
t_R / t_F	Output Rise/Fall Time	20% to 80%		375		ps
odc	Output Duty Cycle			50		%

NOTE 1: Measured from $V_{DD}/2$ of the input to the differential output crossing point.

NOTE 2: Defined as skew between outputs on different devices operating at the same supply voltages and with equal load conditions. Using the same type of inputs on each device, the outputs are measured at the differential cross points.

NOTE 3: This parameter is defined in accordance with JEDEC Standard 65.



PARAMETER MEASUREMENT INFORMATION

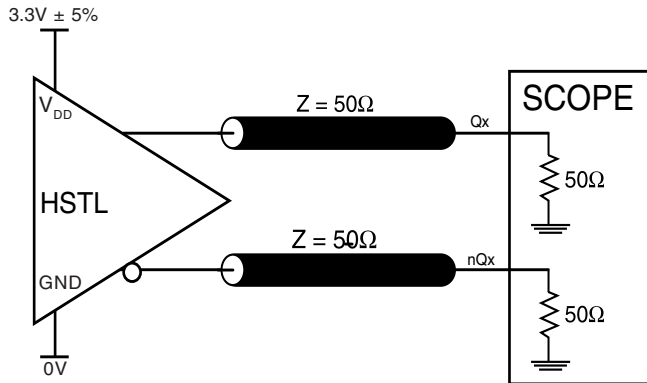

3.3V CORE/3.3V OUTPUT LOAD AC TEST CIRCUIT

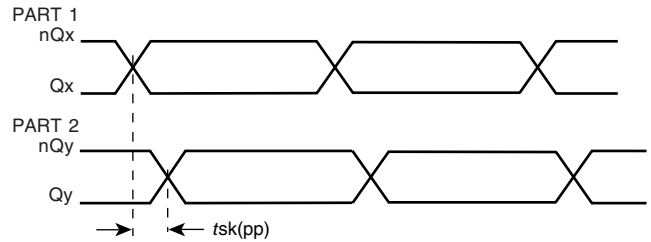

PART-TO-PART SKEW

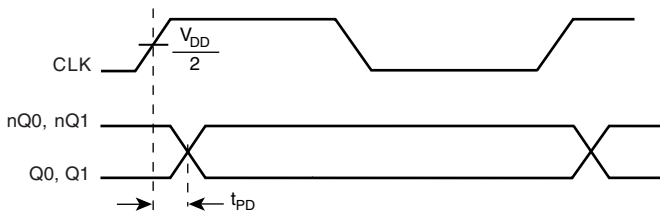

PROPAGATION DELAY

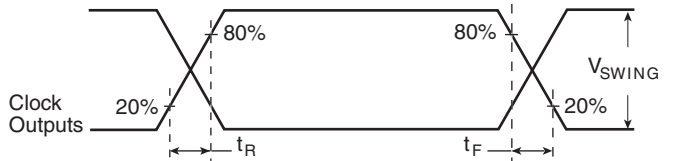

OUTPUT RISE/FALL TIME

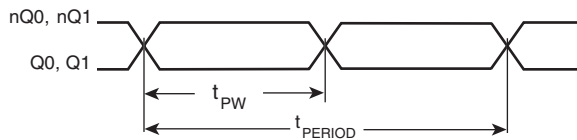

$$odc = \frac{t_{PW}}{t_{PERIOD}} \times 100\%$$

OUTPUT DUTY CYCLE/PULSE WIDTH/PERIOD



Integrated
Circuit
Systems, Inc.

PRELIMINARY

ICS85222-02
1-TO-2 LVCMOS / LVTTTL-TO-
DIFFERENTIAL HSTL TRANSLATOR

APPLICATION INFORMATION

RECOMMENDATIONS FOR UNUSED OUTPUT PINS

OUTPUTS:

HSTL OUTPUT

All unused HSTL outputs can be left floating. We recommend that there is no trace attached. Both sides of the differential output pair should either be left floating or terminated.



POWER CONSIDERATIONS

This section provides information on power dissipation and junction temperature for the ICS85222-02. Equations and example calculations are also provided.

1. Power Dissipation.

The total power dissipation for the ICS85222-02 is the sum of the core power plus the power dissipated in the load(s). The following is the power dissipation for $V_{DD} = 3.3V + 5\% = 3.465V$, which gives worst case results.

NOTE: Please refer to Section 3 for details on calculating power dissipated in the load.

- Power (core)_{MAX} = $V_{DD_MAX} * I_{DD_MAX} = 3.465V * 90mA = 311.85mW$
- Power (outputs)_{MAX} = **73.8mW/Loaded Output pair**
If all outputs are loaded, the total power is $2 * 73.8mW = 147.6mW$

$$\text{Total Power}_{MAX} (3.465V, \text{ with all outputs switching}) = 121.3mW + 147.6mW = 459.5mW$$

2. Junction Temperature.

Junction temperature, T_j , is the temperature at the junction of the bond wire and bond pad and directly affects the reliability of the device. The maximum recommended junction temperature for HiPerClockS™ devices is 125°C.

The equation for T_j is as follows: $T_j = \theta_{JA} * Pd_total + T_A$

T_j = Junction Temperature

θ_{JA} = Junction-to-Ambient Thermal Resistance

Pd_total = Total device power dissipation (example calculation is in Section 1 above)

T_A = Ambient Temperature

In order to calculate junction temperature, the appropriate junction-to-ambient thermal resistance θ_{JA} must be used. Assuming a moderate air flow of 200 linear feet per minute and a multi-layer board, the appropriate value is 103.3°C/W per Table 5 below. Therefore, T_j for an ambient temperature of 70°C with all outputs switching is:

$$70^\circ C + 0.460W * 103.3^\circ C/W = 117.5^\circ C. \text{ This is below the limit of } 125^\circ C.$$

This calculation is only an example. T_j will obviously vary depending on the number of loaded outputs, supply voltage, air flow, and the type of board (single layer or multi-layer).

TABLE 5. THERMAL RESISTANCE θ_{JA} FOR 8-PIN SOIC, FORCED CONVECTION

θ_{JA} by Velocity (Linear Feet per Minute)			
	0	200	500
Single-Layer PCB, JEDEC Standard Test Boards	153.3°C/W	128.5°C/W	115.5°C/W
Multi-Layer PCB, JEDEC Standard Test Boards	112.7°C/W	103.3°C/W	97.1°C/W

NOTE: Most modern PCB designs use multi-layered boards. The data in the second row pertains to most designs.



3. Calculations and Equations.

The purpose of this section is to derive the power dissipated into the load.

HSTL output driver circuit and termination are shown in *Figure 1*.

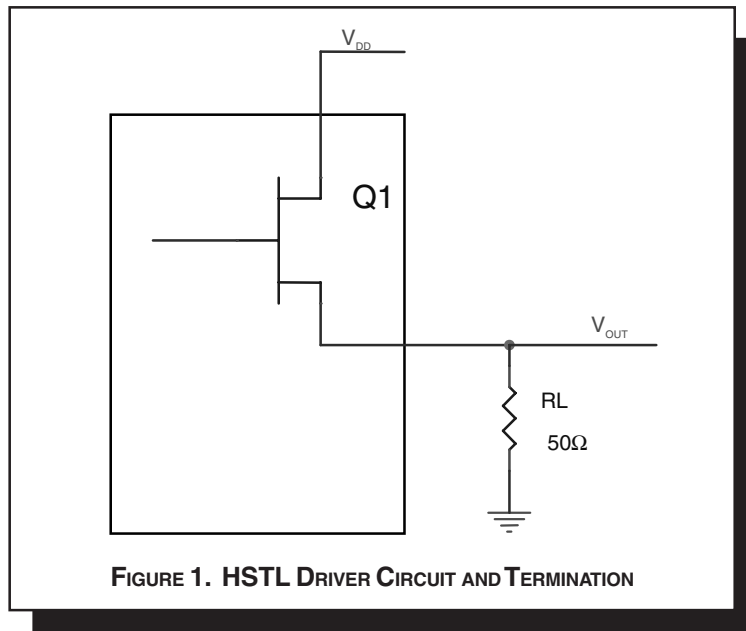

To calculate worst case power dissipation into the load, use the following equations which assume a 50Ω load.

Pd_H is power dissipation when the output drives high.

Pd_L is the power dissipation when the output drives low.

$$Pd_H = (V_{OH_MIN} / R_L) * (V_{DD_MAX} - V_{OH_MIN})$$

$$Pd_L = (V_{OL_MAX} / R_L) * (V_{DD_MAX} - V_{OL_MAX})$$

$$Pd_H = (1V/50\Omega) * (3.465V - 1V) = \mathbf{49.3mW}$$

$$Pd_L = (0.4V/50\Omega) * (3.465V - 0.4V) = \mathbf{24.52mW}$$

$$\text{Total Power Dissipation per output pair} = Pd_H + Pd_L = \mathbf{73.8mW}$$



Integrated
Circuit
Systems, Inc.

PRELIMINARY

ICS85222-02
1-TO-2 LVCMOS / LVTTTL-TO-
DIFFERENTIAL HSTL TRANSLATOR

RELIABILITY INFORMATION

TABLE 6. θ_{JA} vs. AIR FLOW TABLE 8 LEAD SOIC

θ_{JA} by Velocity (Linear Feet per Minute)			
	0	200	500
Single-Layer PCB, JEDEC Standard Test Boards	153.3°C/W	128.5°C/W	115.5°C/W
Multi-Layer PCB, JEDEC Standard Test Boards	112.7°C/W	103.3°C/W	97.1°C/W

NOTE: Most modern PCB designs use multi-layered boards. The data in the second row pertains to most designs.

TRANSISTOR COUNT

The transistor count for ICS85222-02 is: 411



PACKAGE OUTLINE - M SUFFIX FOR 8 LEAD SOIC

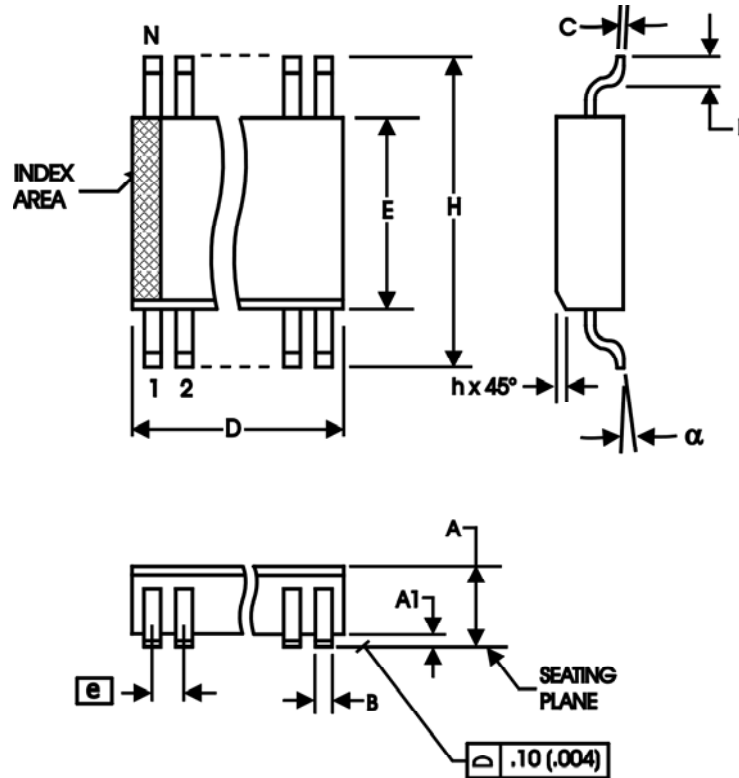

TABLE 7. PACKAGE DIMENSIONS

SYMBOL	Millimeters	
	MINIMUM	MAXIMUM
N	8	
A	1.35	1.75
A1	0.10	0.25
B	0.33	0.51
C	0.19	0.25
D	4.80	5.00
E	3.80	4.00
e	1.27 BASIC	
H	5.80	6.20
h	0.25	0.50
L	0.40	1.27
α	0°	8°

Reference Document: JEDEC Publication 95, MS-012



Integrated
Circuit
Systems, Inc.

PRELIMINARY

ICS85222-02
1-TO-2 LVCMOS / LVTTTL-TO-
DIFFERENTIAL HSTL TRANSLATOR

TABLE 8. ORDERING INFORMATION

Part/Order Number	Marking	Package	Shipping Package	Temperature
ICS85222AM-02	85222A02	8 Lead SOIC	tube	0°C to 70°C
ICS85222AM-02T	85222A02	8 Lead SOIC	2500 tape & reel	0°C to 70°C
ICS85222AM-02LF	TBD	8 Lead "Lead-Free" SOIC	tube	0°C to 70°C
ICS85222AM-02LFT	TBD	8 Lead "Lead-Free" SOIC	2500 tape & reel	0°C to 70°C

NOTE: Parts that are ordered with an "LF" suffix to the part number are the Pb-Free configuration and are RoHS compliant.

The aforementioned trademark, HiPerClockS is a trademark of Integrated Circuit Systems, Inc. or its subsidiaries in the United States and/or other countries.

While the information presented herein has been checked for both accuracy and reliability, Integrated Circuit Systems, Incorporated (ICS) assumes no responsibility for either its use or for infringement of any patents or other rights of third parties, which would result from its use. No other circuits, patents, or licenses are implied. This product is intended for use in normal commercial applications. Any other applications such as those requiring extended temperature range, high reliability, or other extraordinary environmental requirements are not recommended without additional processing by ICS. ICS reserves the right to change any circuitry or specifications without notice. ICS does not authorize or warrant any ICS product for use in life support devices or critical medical instruments.