

**Tantalum Chip Capacitors**  
**Sintered Anode, Solid Semiconductor Electrolyte, +125°C**

ETD

**Structure:**

Tantalum chip capacitors with sintered anode and solid semiconductor electrolyte, flame retardant encapsulation and plated terminals. These terminals are manufactured in a special process and form part of the capacitor body.

In the standard version the leads are tinned, however, goldplated leads are also available for special mounting processes.

Standard: IEC 384-3; CECC 30 000; CECC 30 800

**Note:**

Any mechanical modification of the tantalum anode wire nib may impair the functioning of the component.

**Marking:**

Due to the small dimensions of this chip capacitor – marking with capacitance and voltage is not possible. The corresponding data are indicated on the wrapping for bulk packed resp. on the protective tape at reel units.

**Dimensions**

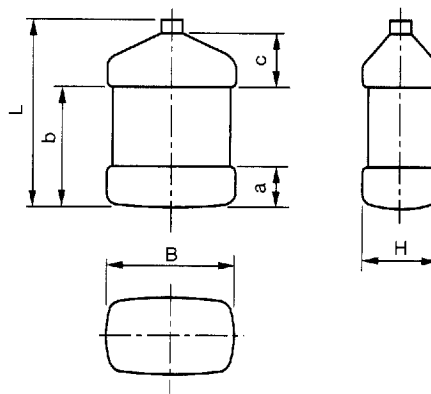

The positive pole is marked by the protruding tantalum anode wire nib.

**Dimensions (mm)**

Case size	L ± 0,2	B max.	H max.	a ± 0,2	b ± 0,2	c min.
0	3	1,8	1,4	0,7	1,6	0,3
1	4,2	1,7	1,7	0,8	2,5	0,3
2	4,2	2,4	1,7	0,8	2,5	0,5
3	5,5	2,4	1,7	1	3,2	0,8
4	6	3,9	2,4	1,1 ± 0,3	3,5 ± 0,3	0,8
5	7	3	3	1,1 ± 0,3	4,5 ± 0,3	0,8
6	7,8	4,1	3,3	1,1 ± 0,3	4,9 ± 0,3	0,8



ETD

**Technical data:****Application class:**

FKE according to DIN 40040

**Climatic class:**

55/125/56 according to IEC

**Temperature range:**

-55°C up to +125°C, as of +85°C derating

**Rated voltage:**

2V- up to 50V-

**Category voltage:**

1,3V- up to 33V-

**Peak voltage:**

1,3 times the rated voltage at +85°C

**Reverse voltage:**

(temporarily)

15% of rated voltage at +20°C

10% of rated voltage at +55°C

5% of rated voltage at +85°C

**Rated capacitance:**

0,1 µF up to 100 µF

**Capacitance tolerance:**

± 20%; close ± 10%

**Leakage current in µA:****(measured at +20°C****after 5 minutes)**≤ 0,01 · C<sub>R</sub> · U<sub>R</sub> or 0,5 µA,

whichever is greater. See table.

(Restricted values upon request).

**Dissipation factor:****(at 120 Hz and +20°C)**

See table

**Impedance:****(measured at 100 kHz and +20°C)**

See table

**Derating:**

See Diagram 1 General Information

**Leakage current behaviour and****changings at different working****voltages:**

See General Information

**Service life:**

&gt; 300 000 hrs. \*)

**Failure percentage:**

≤ 0,7% within 100 000 hrs. \*)

**Failure rate (λ):**≤ 0,7 · 10<sup>-7</sup>/h = ≤ 70 fit \*)

\*) related to U<sub>R</sub> +40°C and a current limiting circuit resistance of ≥ 3Ω/V

**Temperature behaviour:****Features at high and low temperatures (limit values)**

Test temperature	-55°C	+20°C	+85°C	+125°C
Permissible Capacitance change Δ C/C	-10%	-	+10%	+12%
tan δ at 120 Hz	0,1	0,06	0,1	0,12
Leakage current I <sub>R</sub>		≤ 0,01 · C <sub>R</sub> · U <sub>R</sub> or 0,5 µA, whichever is greater	≤ 0,1 · C <sub>R</sub> · U <sub>R</sub> or 5 µA, whichever is greater	≤ 0,125 · C <sub>R</sub> · U <sub>R</sub> or 6,25 µA, whichever is greater

**Failure criteria:**

Complete failure: Short circuit or interruption

Change failure:

ΔC &gt; ±10%

Z &gt; 3 times initial limit value

I<sub>R</sub> > 5 times initial limit value +5 µA

ETD

Case size	Rated cap.	Rated voltage	Category voltage	Dimensions						Leakage current after 5 min. at +20°C	Impedance at 100 kHz +20°C	Dissipation factor at 120 Hz +20°C	Article-No.
	$C_R$	$U_R$	$U_C$	L	B	H	a	b	c	$I_R$	Z	$\tan \delta$	
	$\mu F$	V-	V-	$\pm 0,2$	max.	max.	$\pm 0,2$	$\pm 0,2$	min.	max.	max.	max.	
				mm	mm	mm	mm	mm	mm	$\mu A$	$\Omega$		
0	3,3	2	1,3	3	1,8	1,4	0,7	1,6	0,3	0,5	5,5	0,06	TD 0 335002 M 00
0	4,7	2	1,3	3	1,8	1,4	0,7	1,6	0,3	0,5	4	0,06	TD 0 475002 M 00
0	6,8	2	1,3	3	1,8	1,4	0,7	1,6	0,3	0,5	3,3	0,06	TD 0 685002 M 00
0	10 <sup>1)</sup>	2	1,3	3	1,8	1,4	0,7	1,6	0,3	0,5	6	0,06	TD 0 106002 M 00
0	2,2	4	2,7	3	1,8	1,4	0,7	1,6	0,3	0,5	6,9	0,06	TD 0 225004 M 00
1	4,7	4	2,7	4,2	1,7	1,7	0,8	2,5	0,3	0,5	3,7	0,06	TD 1 475004 M 00
2	10	4	2,7	4,2	2,4	1,7	0,8	2,5	0,5	0,5	3	0,06	TD 2 106004 M 00
3	15	4	2,7	5,5	2,4	1,7	1	3,2	0,8	0,6	1,8	0,06	TD 3 156004 M 00
4	33	4	2,7	6	3,9	2,4	1,1±0,3	3,5±0,3	0,8	1,3	1,3	0,06	TD 4 336004 M 00
5	68	4	2,7	7	3	3	1,1±0,3	4,5±0,3	0,8	2,7	1	0,06	TD 5 686004 M 00
6	100	4	2,7	7,8	4,1	3,3	1,1±0,3	4,9±0,3	0,8	4	0,9	0,06	TD 6 107004 M 00
0	1,5	6	4	3	1,8	1,4	0,7	1,6	0,3	0,5	7,2	0,06	TD 0 155006 M 00
1	3,3	6	4	4,2	1,7	1,7	0,8	2,5	0,3	0,5	4,2	0,06	TD 1 335006 M 00
2	6,8	6	4	4,2	2,4	1,7	0,8	2,5	0,5	0,5	3	0,06	TD 2 685006 M 00
3	10	6	4	5,5	2,4	1,7	1	3,2	0,8	0,6	1,8	0,06	TD 3 106006 M 00
4	22	6	4	6	3,9	2,4	1,1±0,3	3,5±0,3	0,8	1,3	1,3	0,06	TD 4 226006 M 00
5	47	6	4	7	3	3	1,1±0,3	4,5±0,3	0,8	2,8	1	0,06	TD 5 476006 M 00
6	68	6	4	7,8	4,1	3,3	1,1±0,3	4,9±0,3	0,8	4	0,9	0,06	TD 6 686006 M 00
0	1	10	7	3	1,8	1,4	0,7	1,6	0,3	0,5	7,8	0,06	TD 0 105010 M 00
1	2,2	10	7	4,2	1,7	1,7	0,8	2,5	0,3	0,5	4,8	0,06	TD 1 225010 M 00
2	4,7	10	7	4,2	2,4	1,7	0,8	2,5	0,5	0,5	3,3	0,06	TD 2 475010 M 00
3	6,8	10	7	5,5	2,4	1,7	1	3,2	0,8	0,7	1,8	0,06	TD 3 685010 M 00
4	15	10	7	6	3,9	2,4	1,1±0,3	3,5±0,3	0,8	1,5	1,5	0,06	TD 4 156010 M 00
5	33	10	7	7	3	3	1,1±0,3	4,5±0,3	0,8	3	1,2	0,06	TD 5 336010 M 00
6	47	10	7	7,8	4,1	3,3	1,1±0,3	4,9±0,3	0,8	4,7	0,9	0,06	TD 6 476010 M 00
0	0,68	15	10	3	1,8	1,4	0,7	1,6	0,3	0,5	10	0,06	TD 0 684015 M 00
1	1,5	15	10	4,2	1,7	1,7	0,8	2,5	0,3	0,5	5,1	0,06	TD 1 155015 M 00
2	3,3	15	10	4,2	2,4	1,7	0,8	2,5	0,5	0,5	3,9	0,06	TD 2 335015 M 00
3	4,7	15	10	5,5	2,4	1,7	1	3,2	0,8	0,7	2,1	0,06	TD 3 475015 M 00
4	10	15	10	6	3,9	2,4	1,1±0,3	3,5±0,3	0,8	1,5	1,5	0,06	TD 4 106015 M 00
5	22	15	10	7	3	3	1,1±0,3	4,5±0,3	0,8	3,3	1,2	0,06	TD 5 226015 M 00
6	33	15	10	7,8	4,1	3,3	1,1±0,3	4,9±0,3	0,8	5	0,9	0,06	TD 6 336015 M 00

Ordering example: TD 0 335002 M 00

<sup>1)</sup> Special value (high volume capacity)

Bulk packed  
 In case of differing packing "00" to be replaced by corresponding code  
 (see packaging) or clear text to indicate.  
 Capacitance tolerances: M  $\hat{=}$   $\pm 20\%$  K  $\hat{=}$   $\pm 10\%$



ETD

Case size	Rated cap.	Rated voltage	Category voltage	Dimensions						Leakage current after 5 min. at +20°C	Impedance at 100 kHz +20°C	Dissipation factor at 120 Hz +20°C	Article-No.
	C <sub>R</sub>	U <sub>R</sub>	U <sub>C</sub>	L	B	H	a	b	c	I <sub>R</sub>	Z	tan δ	
	μF	V-	V-	±0,2 mm	max. mm	max. mm	±0,2 mm	±0,2 mm	min. mm	max. μA	max. Ω	max.	
0	0,47	20	13	3	1,8	1,4	0,7	1,6	0,3	0,5	13	0,06	TD 0 474020 M 00
1	1	20	13	4,2	1,7	1,7	0,8	2,5	0,3	0,5	6,9	0,06	TD 1 105020 M 00
2	2,2	20	13	4,2	2,4	1,7	0,8	2,5	0,5	0,5	4,2	0,06	TD 2 225020 M 00
3	3,3	20	13	5,5	2,4	1,7	1	3,2	0,8	0,7	2,4	0,06	TD 3 335020 M 00
4	6,8	20	13	6	3,9	2,4	1,1±0,3	3,5±0,3	0,8	1,4	1,7	0,06	TD 4 685020 M 00
5	15	20	13	7	3	3	1,1±0,3	4,5±0,3	0,8	3	1,2	0,06	TD 5 156020 M 00
6	22	20	13	7,8	4,1	3,3	1,1±0,3	4,9±0,3	0,8	4	1,1	0,06	TD 6 226020 M 00
0	0,33	25	17	3	1,8	1,4	0,7	1,6	0,3	0,5	15	0,06	TD 0 334025 M 00
1	0,68	25	17	4,2	1,7	1,7	0,8	2,5	0,3	0,5	7,2	0,06	TD 1 684025 M 00
2	1,5	25	17	4,2	2,4	1,7	0,8	2,5	0,5	0,5	4,8	0,06	TD 2 155025 M 00
3	2,2	25	17	5,5	2,4	1,7	1	3,2	0,8	0,6	3,3	0,06	TD 3 225025 M 00
4	4,7	25	17	6	3,9	2,4	1,1±0,3	3,5±0,3	0,8	1,2	1,8	0,06	TD 4 475025 M 00
5	6,8	25	17	7	3	3	1,1±0,3	4,5±0,3	0,8	1,7	1,5	0,06	TD 5 685025 M 00
5	10	25	17	7	3	3	1,1±0,3	4,5±0,3	0,8	2,5	1,2	0,06	TD 5 106025 M 00
6	15	25	17	7,8	4,1	3,3	1,1±0,3	4,9±0,3	0,8	3,8	1,1	0,06	TD 6 156025 M 00
0	0,22	35	23	3	1,8	1,4	0,7	1,6	0,3	0,5	17	0,06	TD 0 224035 M 00
1	0,47	35	23	4,2	1,7	1,7	0,8	2,5	0,3	0,5	7,6	0,06	TD 1 474035 M 00
2	1	35	23	4,2	2,4	1,7	0,8	2,5	0,5	0,5	5	0,06	TD 2 105035 M 00
3	1,5	35	23	5,5	2,4	1,7	1	3,2	0,8	0,5	3	0,06	TD 3 155035 M 00
4	3,3	35	23	6	3,9	2,4	1,1±0,3	3,5±0,3	0,8	1,1	1,6	0,06	TD 4 335035 M 00
5	4,7	35	23	7	3	3	1,1±0,3	4,5±0,3	0,8	1,6	1	0,06	TD 5 475035 M 00
6	6,8	35	23	7,8	4,1	3,3	1,1±0,3	4,9±0,3	0,8	2,4	0,8	0,06	TD 6 685035 M 00
0	0,1	50	33	3	1,8	1,4	0,7	1,6	0,3	0,5	26	0,06	TD 0 104050 M 00
0	0,15	50	33	3	1,8	1,4	0,7	1,6	0,3	0,5	19	0,06	TD 0 154050 M 00
1	0,22	50	33	4,2	1,7	1,7	0,8	2,5	0,3	0,5	12	0,06	TD 1 224050 M 00
1	0,33	50	33	4,2	1,7	1,7	0,8	2,5	0,3	0,5	8	0,06	TD 1 334050 M 00
2	0,47	50	33	4,2	2,4	1,7	0,8	2,5	0,5	0,5	6	0,06	TD 2 474050 M 00
2	0,68	50	33	4,2	2,4	1,7	0,8	2,5	0,5	0,5	5	0,06	TD 2 684050 M 00
3	1	50	33	5,5	2,4	1,7	1	3,2	0,8	0,5	3	0,06	TD 3 105050 M 00
4	1,5	50	33	6	3,9	2,4	1,1±0,3	3,5±0,3	0,8	0,8	2,5	0,06	TD 4 155050 M 00
4	2,2	50	33	6	3,9	2,4	1,1±0,3	3,5±0,3	0,8	1,1	1,6	0,06	TD 4 225050 M 00
5	3,3	50	33	7	3	3	1,1±0,3	4,5±0,3	0,8	1,7	1,2	0,06	TD 5 335050 M 00
6	4,7	50	33	7,8	4,1	3,3	1,1±0,3	4,9±0,3	0,8	2,4	0,8	0,06	TD 6 475050 M 00

**Packaging:**

Sizes	Code	Clear text
0-6	00	Bulk packed
0-3	C 70	reel, 8 mm tape
1-6	C 71	reel, 12 mm tape

Taping according to IEC 286-3, see page 9

**Packaging units:** See page 10

**ETD**

**Diagram 1:** ETD 0 Impedance (typical) versus frequency

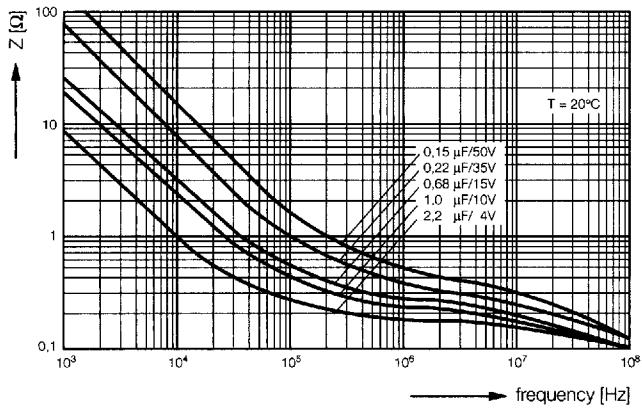

**Diagram 4:** ETD 0 ESR (typical) versus frequency

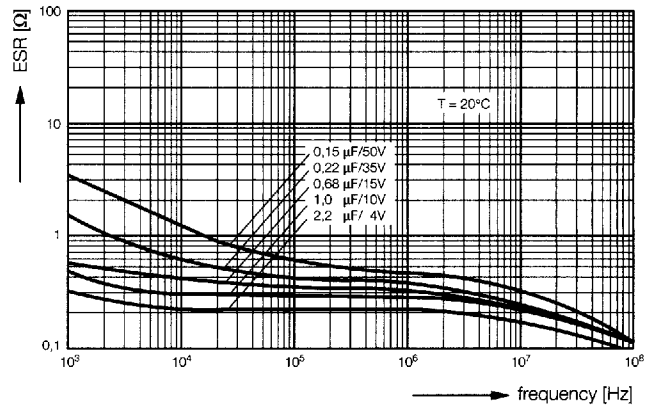

**Diagram 2:** ETD 1 Impedance (typical) versus frequency

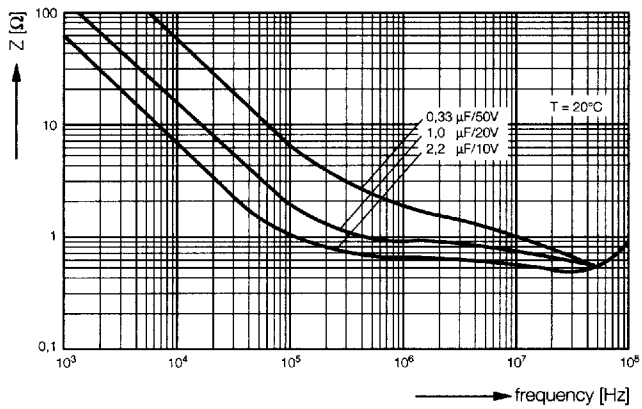

**Diagram 5:** ETD 1 ESR (typical) versus frequency

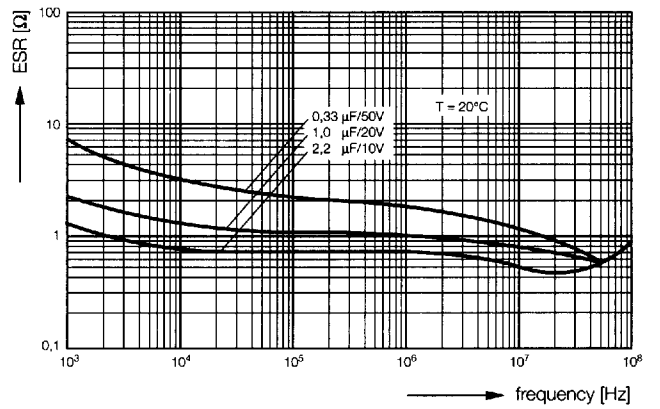

**Diagram 3:** ETD 2 Impedance (typical) versus frequency

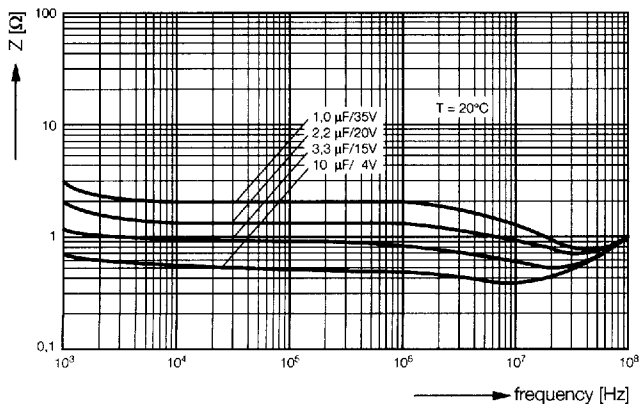

**Diagram 6:** ETD 2 ESR (typical) versus frequency

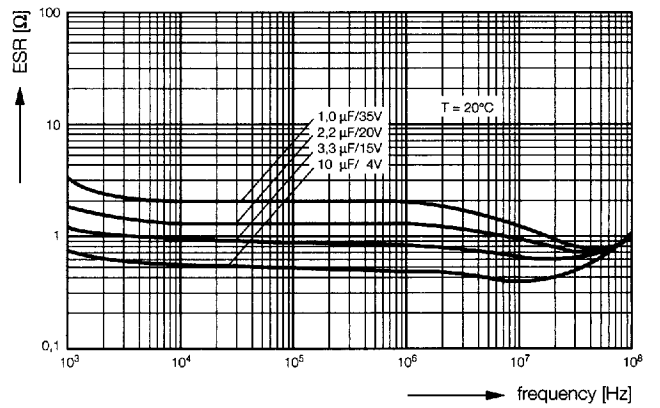



ETD

Diagram 7: ETD 3 Impedance (typical) versus frequency

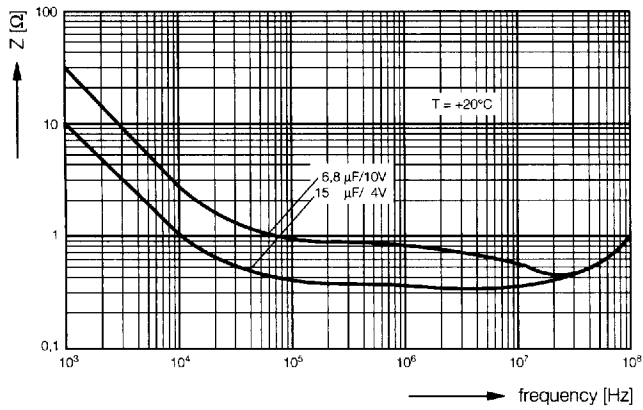

Diagram 10: ETD 3 ESR (typical) versus frequency

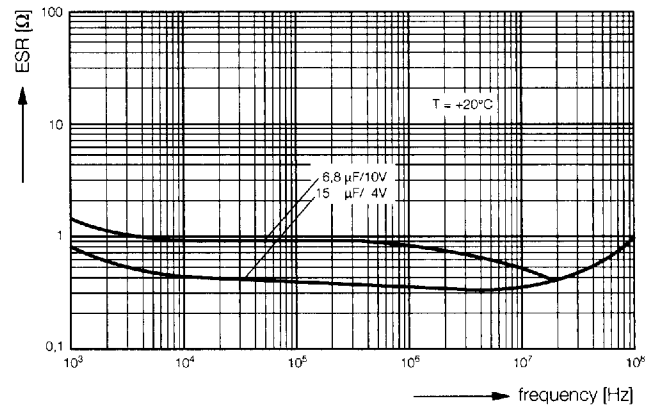

Diagram 8: ETD 4 Impedance (typical) versus frequency

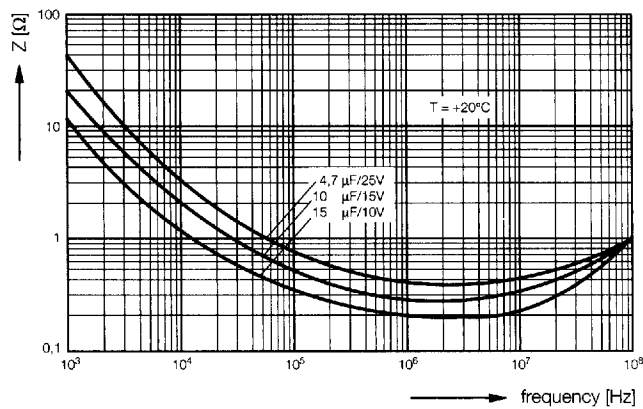

Diagram 11: ETD 4 ESR (typical) versus frequency

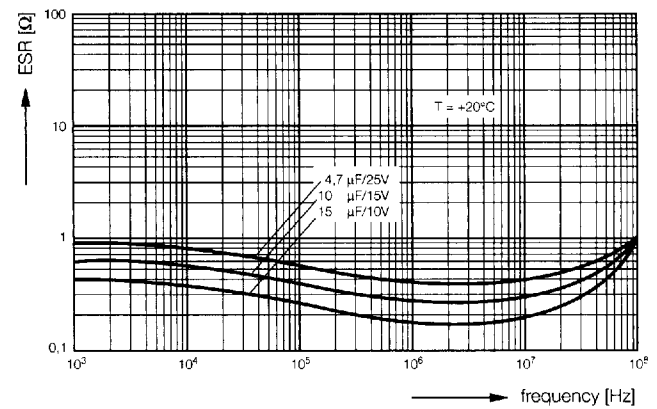

Diagram 9: ETD 5 Impedance (typical) versus frequency

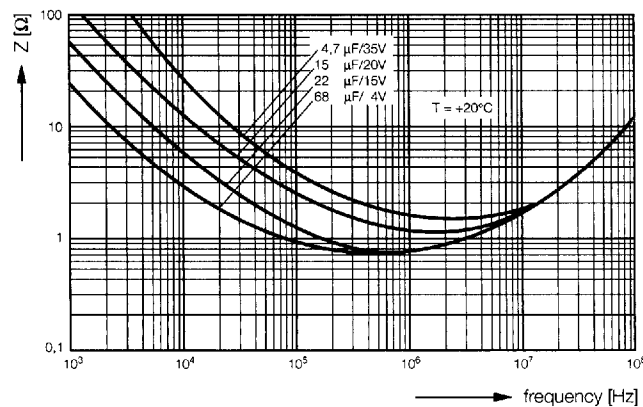
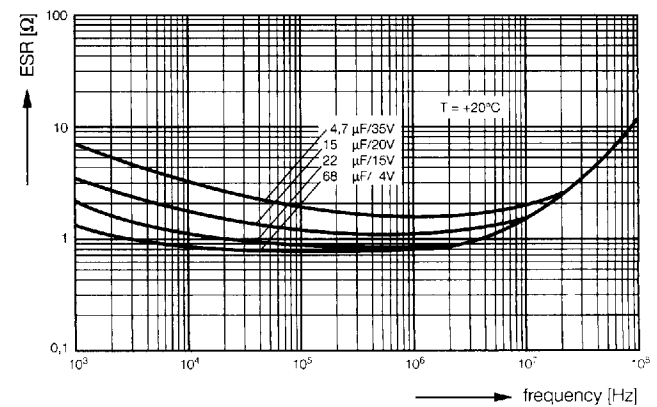
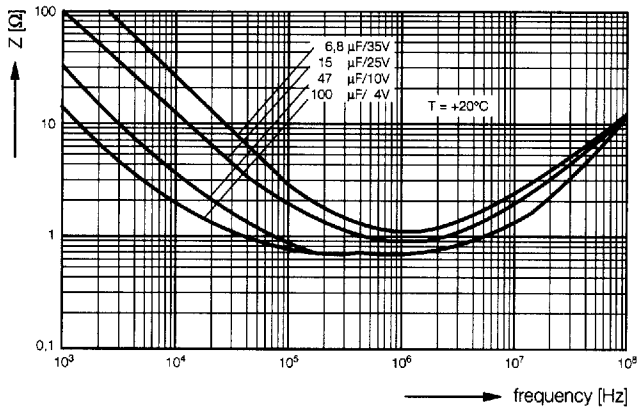

Diagram 12: ETD 5 ESR (typical) versus frequency



**ETD**

**Diagram 13:** ETD 6 Impedance (typical) versus frequency



**Diagram 15:** ETD 6 ESR (typical) versus frequency

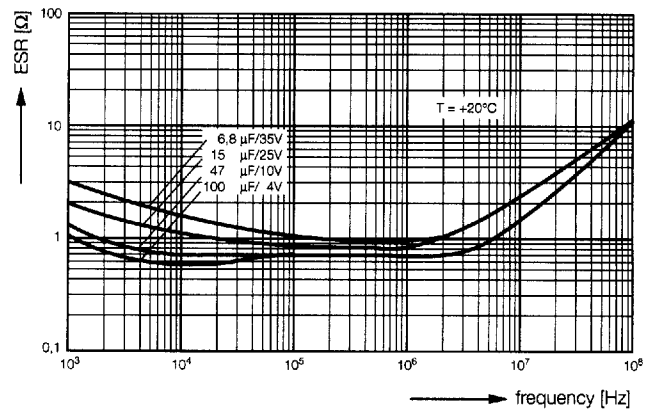

**Diagram 14:** Impedance multiplier for extreme temperatures

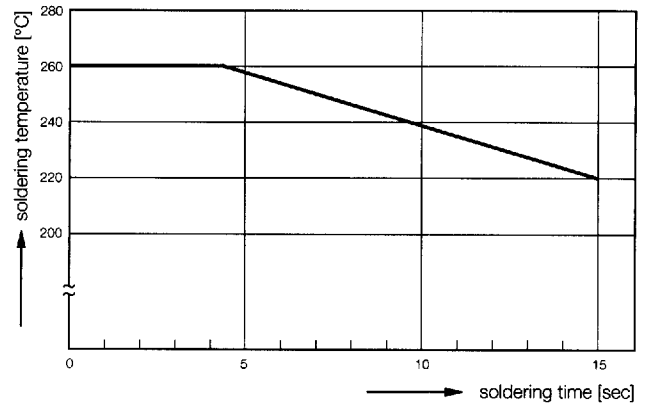
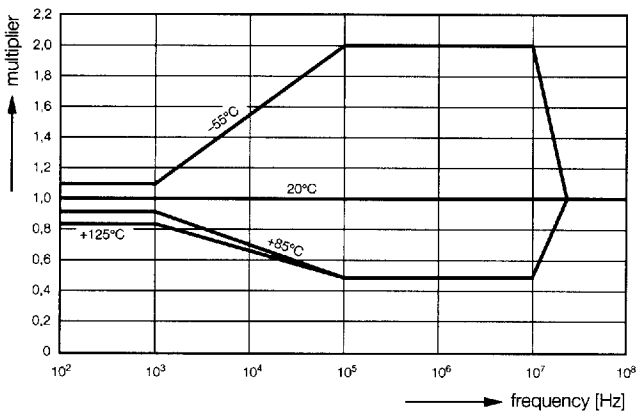

"Worst-case" calculation:  
Multiplier x Z-value (+20°C)  
(see Diagrams)

**Maximum soldering temperature as function of the soldering time.**

The ETD type can be processed both with conventional and vapour-phase soldering methods.  
A processing with soldering iron is not to recommend, if the soldering time and soldering temperature cannot be supervised.



ETD

**Notes of the location of the soldering surfaces for the ETD type:**

These notes do not take into consideration the possible layout tolerances and the positioning accuracy of the insertion machines, as they differ from case to case. These notes are no rule either, they are merely supposed to be a help when determining the layout. Generally, the soldering surfaces may be selected smaller for the reflow method than for wave soldering.

**Dimensions**

