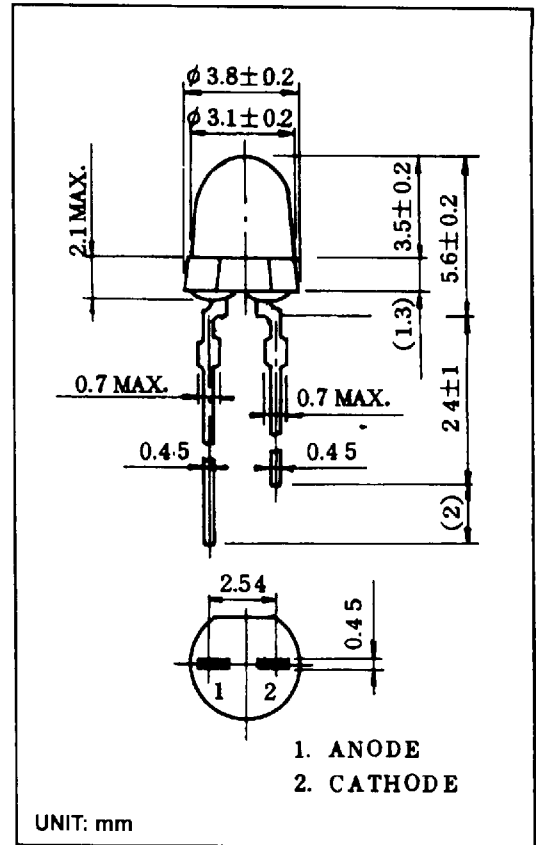

RED**T-1 Ultra Bright LED**High Performance
Ultra Bright LEDs**TLRA125****Product Features -**

- GaAlAs Technology
- T-1 (3 mm) Package
- Water Clear Lens
- Wide Radiation Pattern

MAXIMUM RATINGS (Ta = 25°C)

| CHARACTERISTIC | SYMBOL | RATING | UNIT |
|-----------------------|-----------|-----------|------|
| Forward Current | I_F | 25 | mA |
| Reverse Voltage | V_R | 4 | V |
| Power Dissipation | P_D | 55 | mW |
| Operating Temperature | T_{opr} | -20 ~ 85 | °C |
| Storage Temperature | T_{stg} | -30 ~ 100 | °C |

**OPTO-ELECTRICAL CHARACTERISTICS (Ta = 25°C)**

| CHARACTERISTIC | SYMBOL | TEST CONDITION | MIN. | TYP. | MAX. | UNIT |
|--------------------------|-----------------|----------------|------|------|------|---------|
| Forward Voltage | V_F | IF = 20mA | — | 1.85 | 2.2 | V |
| Reverse Current | I_R | VR = 4V | — | — | 100 | μ A |
| Luminous Intensity* | I_V | IF = 20mA | 85 | 300 | — | mcd |
| Viewing Angle | $2\theta_{1/2}$ | — | — | 50 | — | ° |
| Peak Wavelength | λ_p | IF = 20mA | — | 660 | — | nm |
| Dominant Wavelength | λ_d | IF = 20mA | — | 647 | — | nm |
| Spectral Line Half Width | $\Delta\lambda$ | IF = 20mA | — | 25 | — | nm |

* Luminous Ranks: (P : 180-360mcd), (Q : 320-640mcd), (R : 560-1120mcd) Upper and lower limit tolerance $\pm 15\%$
Available in Two Bin Combinations. (PQ), (QR)

5 Hemlock Street • Latham, New York 12110

Toll Free: (800) 98-4LEDS • Fax: (518) 786-6599

All specifications subject to change.

TLRA125 Graphs -

High Performance
Ultra Bright LEDs

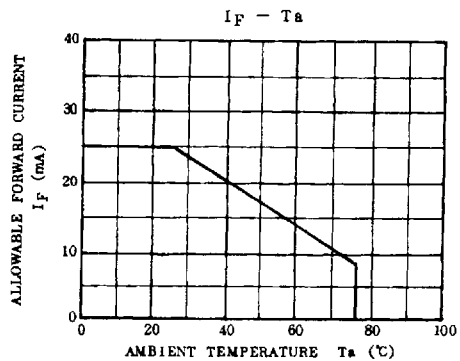
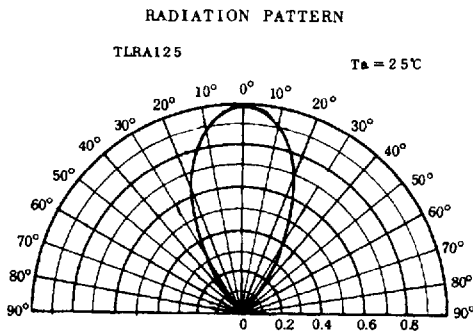
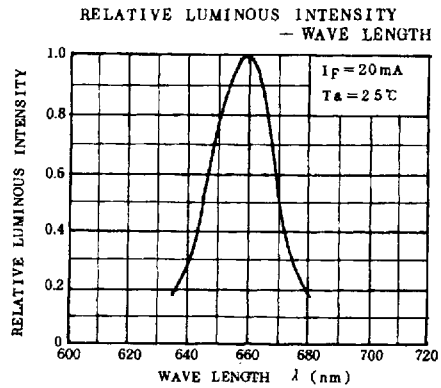
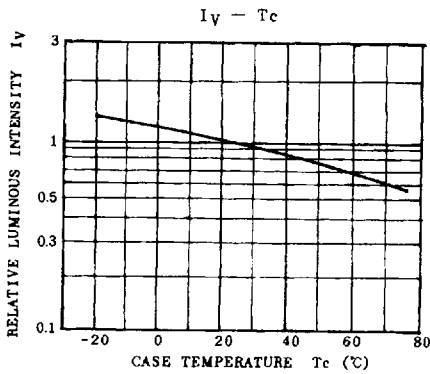
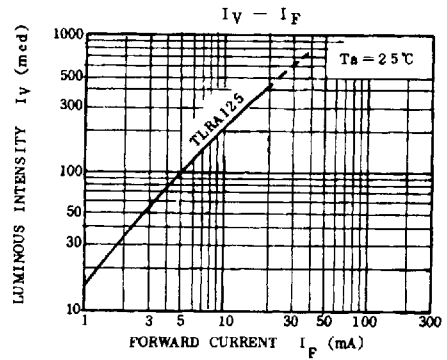
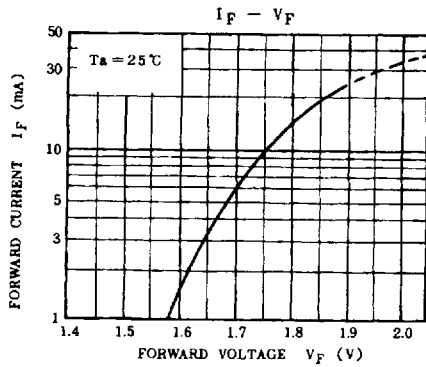

APPLICATION NOTES

[4] Packaging Reel Packaging

a) Reel type

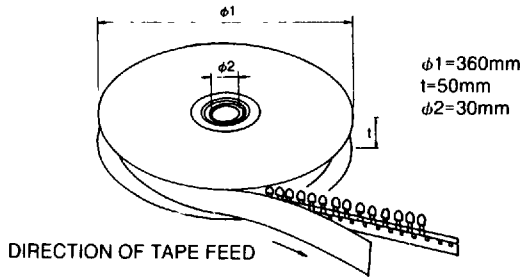

Content

| LED Type | Quantity/Reel |
|-----------------|---------------|
| $\phi 3$ Series | 2000 pcs |
| $\phi 5$ Series | 1000 pcs |

T-1 and T- 1 3/4 packages

*Lamps with external shapes other than those above are also available. Please consult Marktech.

b) Zigzag wound tape

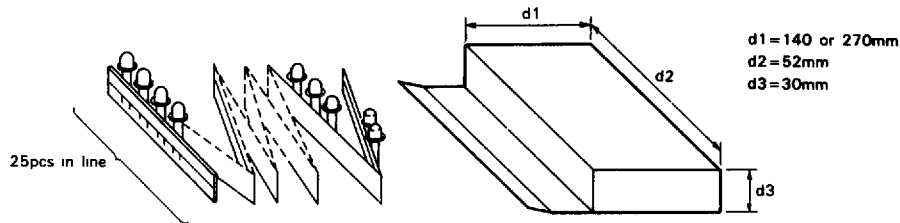

At tape beginning and end, there is additional space for 4 pcs or more

Content

| LED Type | Quantity/Box |
|-----------------|------------------|
| $\phi 3$ Series | 2000 or 5000 pcs |
| $\phi 5$ Series | 1000 or 2000 pcs |



marktech

5 Hemlock Street • Latham, New York • (518) 786-6591 • FAX (518) 786-6599