



TSM3401

-30V P-Channel Enhancement Mode MOSFET

SOT-23



Pin assignment:

1. Gate
2. Source
3. Drain

$V_{DS} = -30V$

$R_{DS(on)}, V_{GS} @ -4.5V, I_{DS} @ -2A = 100m\Omega$

$R_{DS(on)}, V_{GS} @ -10V, I_{DS} @ -3A = 75m\Omega$

Features

- ◇ Rugged and reliable
- ◇ Excellent thermal and electrical capabilities
- ◇ High density cell design for ultra low on-resistance
- ◇ Compact and low profile SOT-23 package

Block Diagram

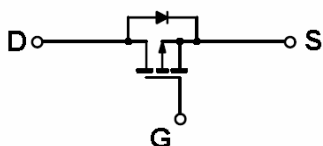

Ordering Information

Part No.	Packing	Package
TSM3401CX	Tape & Reel	SOT-23

Absolute Maximum Rating (Ta = 25 °C unless otherwise noted)

Parameter	Symbol	Limit	Unit
Drain-Source Voltage	V_{DS}	- 30V	V
Gate-Source Voltage	V_{GS}	± 20	V
Continuous Drain Current	I_D	- 3	A
Pulsed Drain Current	I_{DM}	- 10	A
Maximum Power Dissipation	P_D	Ta = 25 °C	1.25
		Ta = 75 °C	0.8
Operating Junction Temperature	T_J	+150	°C
Operating Junction and Storage Temperature Range	T_J, T_{STG}	- 55 to +150	°C

Thermal Performance

Parameter	Symbol	Limit	Unit
Lead Temperature (1/8" from case)	T_L	5	S
Junction to Ambient Thermal Resistance (PCB mounted)	$R_{\theta ja}$	100	°C/W

Note: Surface mounted on FR4 board $t \leq 5$ sec.

Electrical Characteristics						
Ta = 25 °C, unless otherwise noted						
Parameter	Conditions	Symbol	Min	Typ	Max	Unit
Static						
Drain-Source Breakdown Voltage	V _{GS} = 0V, I _D = -250uA	BV _{DSS}	-30	--	--	V
Drain-Source On-State Resistance	V _{GS} = -10V, I _D = -3A	R _{DS(ON)}	--	--	75	mΩ
Drain-Source On-State Resistance	V _{GS} = -4.5V, I _D = -2A	R _{DS(ON)}	--	--	100	
Gate Threshold Voltage	V _{DS} = V _{GS} , I _D = -250uA	V _{GS(TH)}	-1	-1.5	-2.5	V
Zero Gate Voltage Drain Current	V _{DS} = -24V, V _{GS} = 0V	I _{DSS}	--	--	-1.0	uA
Gate Body Leakage	V _{GS} = ±20V, V _{DS} = 0V	I _{GSS}	--	--	±100	nA
On-State Drain Current	V _{DS} = -5V, V _{GS} = -10V	I _{D(ON)}	6	--	--	A
Forward Transconductance	V _{DS} = -5V, I _D = -3A	g _{fs}	--	5	--	S
Dynamic						
Total Gate Charge	V _{DS} = -15V, I _D = -3A, V _{GS} = -10V	Q _g	--	13.5	--	nC
	V _{DS} = -15V, I _D = -3A, V _{GS} = -4.5V		--	7	--	
Gate-Source Charge	V _{DS} = -15V, I _D = -3A, V _{GS} = -10V	Q _{gs}	--	2.3	--	
Gate-Drain Charge		Q _{gd}	--	2.8	--	
Turn-On Delay Time	V _{DD} = -15V, R _L = 15Ω, I _D = -1A, V _{GEN} = -10V, R _G = 6Ω	t _{d(on)}	--	13	--	nS
Turn-On Rise Time		t _r	--	7	--	
Turn-Off Delay Time		t _{d(off)}	--	58	--	
Turn-Off Fall Time		t _f	--	26	--	
Input Capacitance	V _{DS} = -15V, V _{GS} = 0V, f = 1.0MHz	C _{iss}	--	653	--	pF
Output Capacitance		C _{oss}	--	130	--	
Reverse Transfer Capacitance		C _{rss}	--	97	--	
Source-Drain Diode						
Diode Forward Voltage	I _S = -1.6A, V _{GS} = 0V	V _{SD}	--	-0.8	-1.2	V

Note : pulse test: pulse width ≤300uS, duty cycle ≤2%

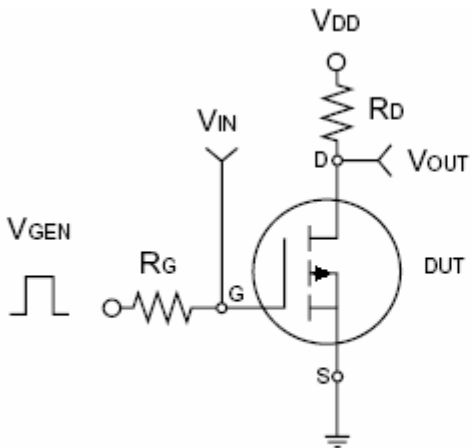

Switching Test Circuit

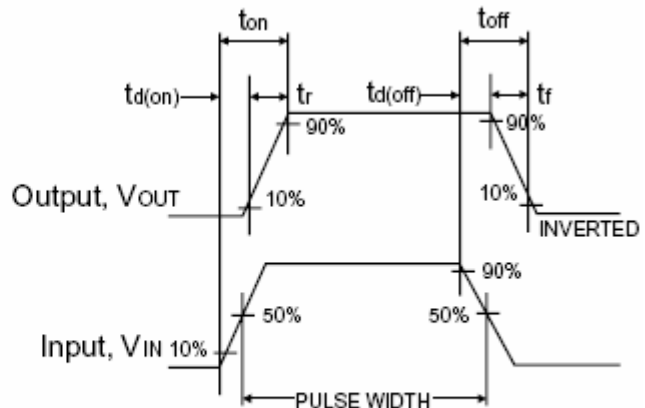

Switchin Waveforms



Typical Characteristics Curve ($T_a = 25^\circ\text{C}$ unless otherwise noted)

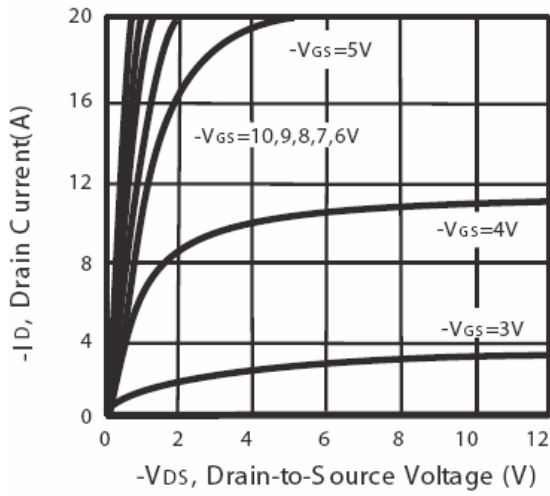

Figure 1. Output Characteristics

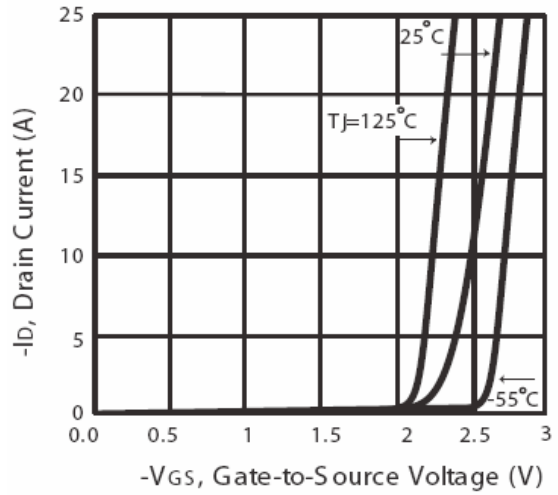

Figure 2. Transfer Characteristics

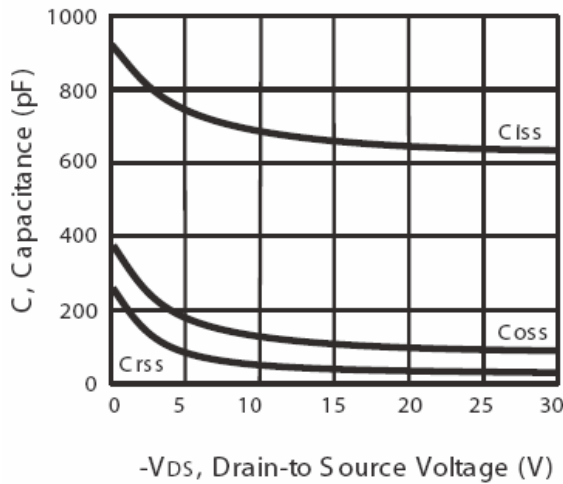

Figure 3. Capacitance

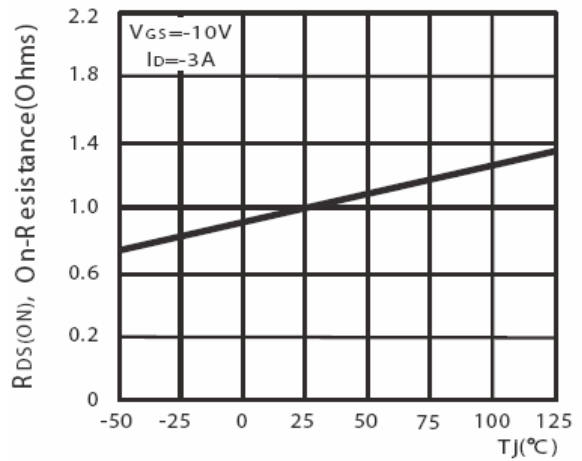

Figure 4. On-Resistance Variation with Temperature

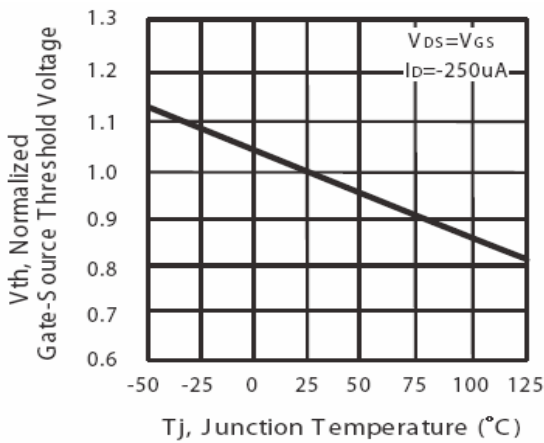

Figure 5. Gate-Source Threshold Voltage with Temperature

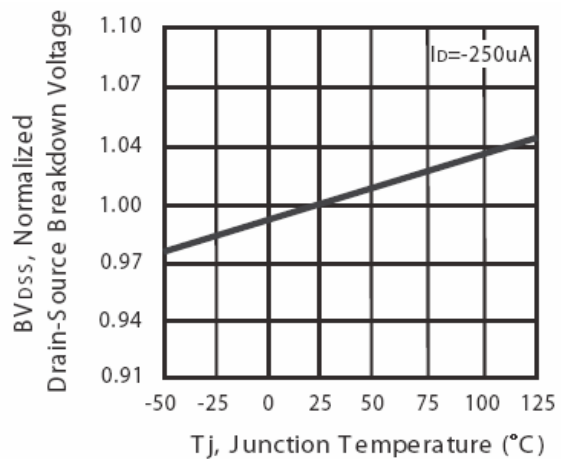

Figure 6. Breakdown Voltage Variation with Temperature

Typical Characteristics Curve ($T_a = 25^\circ\text{C}$ unless otherwise noted)

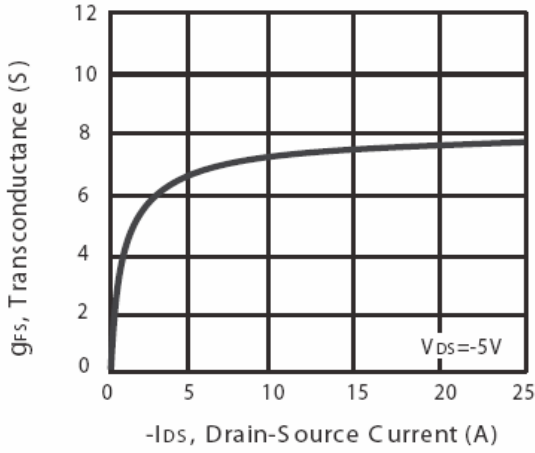

Figure 7. Transconductance Variation with Drain Current

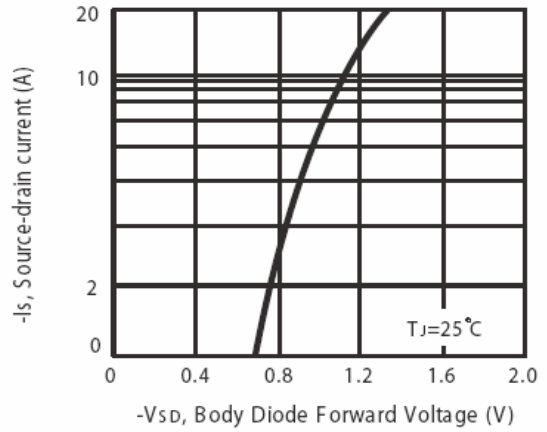

Figure 8. Body Diode Forward Voltage Variation with Source Current

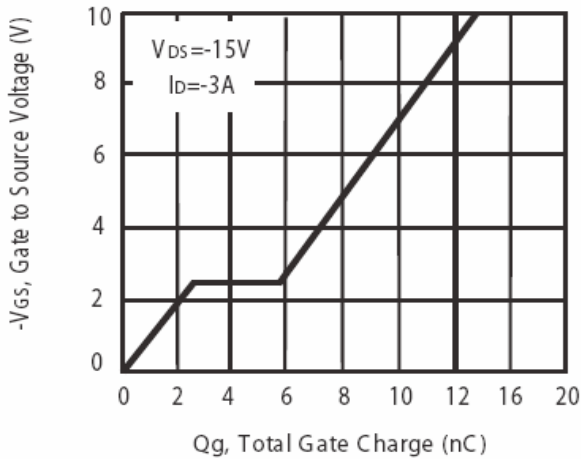

Figure 9. Gate Charge

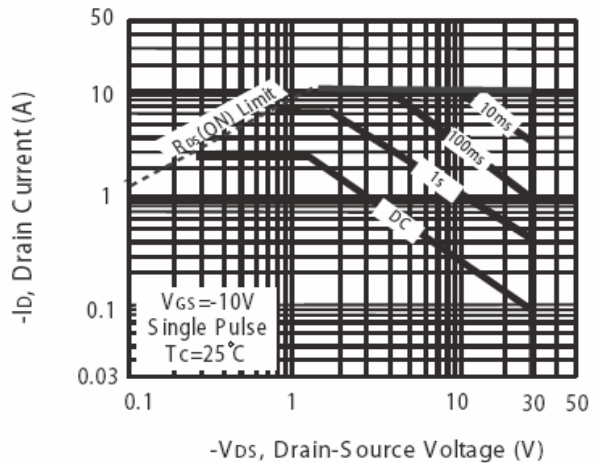
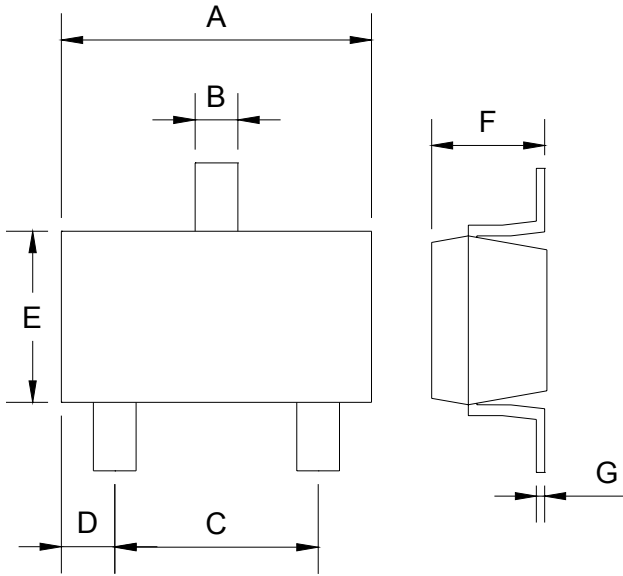

Figure 10. Maximum Safe Operating Area

SOT-23 Mechanical Drawing



SOT-23 DIMENSION				
DIM	MILLIMETERS		INCHES	
	MIN	MAX	MIN	MAX
A	2.88	2.91	0.113	0.115
B	0.39	0.42	0.015	0.017
C	1.78	2.03	0.070	0.080
D	0.51	0.61	0.020	0.024
E	1.59	1.66	0.063	0.065
F	1.04	1.08	0.041	0.043
G	0.07	0.09	0.003	0.004