

FlatPAC™

50 to 600 W
Auroranging
AC-DC Switchers



Product Highlights

If you're looking for the convenience of a complete, low profile, agency-approved switching power supply, look no further. The FlatPAC combines Vicor's workhorse VI-200 family of DC-DC converters with a modular package and front-end subassembly to provide from 50 to 600 W of output power from one to three outputs.

A flat plate heat sink for use in conduction cooled applications may be specified as an alternate to the standard finned version by adding "CC" to the end of the model number.

Vicor's FlatPAC is also available with a current controlled output using BatMod converter modules of 12, 24, or 48 Vdc outputs. This option is specified by appending "BM" or "BC" (for conduction cooled versions) to the end of the FlatPAC model number.

The FlatPAC's contemporary design allows us to configure your order quickly and provide rapid turnaround on standard models. It is truly a complete power solution, enabling you to spend more time designing your system and less time worrying about how to power it.

Features

- Microcontroller architecture
- Inputs: 115/230 Vac autoranging
- Meets FCC Part 15, EN55022, Class B conducted emissions
- 80-90% efficiency
- Any output: 1 to 95 Vdc
- Module enable/disable (except LU series)
- UL, TÜV, VDE, CE marked
- Remote sense and current limit
- BUS OK and AC OK (except LU series)
- 40 mS ride-through time
- OVP and thermal shutdown
- 1 output; up to 200 W
- 1 or 2 outputs; up to 400 W
- 1, 2, or 3 outputs; up to 600 W

FlatPAC Configuration Chart

Typical Model: VI-RU 0 1 1 - E U U U - ::::

Input: 115/230 Vac; Output 1: 5 Vdc at 200 W
Output 2: 12 Vdc at 200 W
Output 3: 12 Vdc at 200 W

	Total Power	Part No.	# of Converters	Dimensions
Single Outputs:	50-200 W	VI-LU [Red] - [Blue] [Yellow]	1	9.25" x 2.5" x 1.37" (234,8 x 63,5 x 34,8 mm)
	200-400 W	VI-MU [Red] - [Blue] [Yellow]	2	9.25" x 4.9" x 1.37" (234,8 x 124,5 x 34,8 mm)
	300-600 W	VI-NU [Red] - [Blue] [Yellow]	3	9.25" x 7.3" x 1.37" (234,8 x 185,4 x 34,8 mm)
Dual Outputs:	100-400 W	VI-PU [Red] [Red] - [Blue] [Yellow] [Yellow]	2	9.25" x 4.9" x 1.37" (234,8 x 124,5 x 34,8 mm)
	150-600 W	VI-QU [Red] [Red] - [Blue] [Yellow] [Yellow]	3	9.25" x 7.3" x 1.37" (234,8 x 185,4 x 34,8 mm)
Triple Outputs:	150-600 W	VI-RU [Red] [Red] [Red] - [Blue] [Yellow] [Yellow]	3	9.25" x 7.3" x 1.37" (234,8 x 185,4 x 34,8 mm)

Input Characteristics

90-132/180-264 Vac
U = Autoranging

Output Power

V_{out} ≥ 5 V	V_{out} < 5 V
W = 100 W	W = 20 A
V = 150 W	V = 30 A
U = 200 W	U = 40 A
S = 300 W	S = 60 A
Q = 400 W	Q = 80 A

Output Voltage

Z 2 V	M 10 V	K 40 V
Y 3.3 V	1 12 V	4 48 V
0 5 V	P 13.8 V	H 52 V
X 5.2 V	2 15 V	F 72 V
W 5.5 V	N 18.5 V	D 85 V
V 5.8 V	3 24 V	B 95 V
T 6.5 V	L 28 V	
R 7.5 V	J 36 V	

Product Grade

E = 0°C to +85°C Case
C = 0°C to +85°C Case
I = -30°C to +85°C Case

Output Power/Current

V_{out} ≥ 5 V	V_{out} < 5 V
S = 300 W	S = 60 A
P = 450 W	P = 90 A
M = 600 W	M = 120 A

Output Power/Current

V_{out} ≥ 5 V	V_{out} < 5 V
Y = 50 W	Y = 10 A
X = 75 W	X = 15 A
W = 100 W	W = 20 A
V = 150 W	V = 30 A
U = 200 W	U = 40 A

Options

BC= BatMod/Conduction Cooled
BM= BatMod
CC= Conduction Cooled

FlatPAC Specifications

(Typical at 25°C, nominal line and 75% load, unless otherwise specified.)

Input Characteristics	
AC line input	
Autoranging	90-132/180-264 Vac
Line frequency	47 to 63 Hz (C-grade and E-grade) 47 to 440 Hz (I-grade)
Inrush current	
115 Vac operation	1 converter: 16 A @ peak line; 2 converters: 23 A @ peak line; 3 converters: 39 A @ peak line
230 Vac operation	1 converter: 32 A @ peak line; 2 converters: 47 A @ peak line; 3 converters: 78 A @ peak line
Ride-through time (full load)	
90/180 Vac low line	5 ms minimum
115/230 Vac nominal line	40 ms minimum
AC fail warning time	5 ms minimum (low line, full load)
AC and BUS OK (2 and 3 converter models only)	
Off state	V _{ce} = 70 V maximum
On state	V _{cesat} = 0.4 V maximum @ 1 mA (1.5 mA max.)
Module disable (2 and 3 converter models only, optically isolated LED input)	
Continuous forward current	1 mA to 30 mA
Forward voltage	1.65 V max. at 30 mA
Dielectric withstand	
Primary to chassis GND	2,121 Vdc
Primary to secondary	4,242 Vdc
Secondary to chassis GND	707 Vdc

Output Characteristics (applies to each output individually)								
	E-Grade			C-, I-Grade			UNITS	NOTES
	MIN.	TYP.	MAX.	MIN.	TYP.	MAX		
Set point accuracy		1%	2%		0.5%	1%	V _{NOM}	
Load/line regulation			0.5%		0.05%	0.2%	V _{NOM}	LL to HL, 10% to Full Load
Load/line regulation			1%		0.2%	0.5%	V _{NOM}	LL to HL, No Load to full load
Output temperature drift		0.02			0.01	0.02	%/°C	Over rated temperature
Long term drift		0.02			0.02		%/1 k hours	
Output ripple								
2 V			150 mV		60 mV	100 mV	p-p	20 MHz bandwidth
5 V			5%		2%	3%	p-p	20 MHz bandwidth
10-48 V			3%		0.75%	1.5%	p-p	20 MHz bandwidth
Output voltage trimming ¹	50%		110%	50%		110%		
Total remote sense compensation	0.5			0.5			Volts	0.25 V max. neg. leg
OVP set point		125%		115%	125%	135%	V _{NOM}	Recycle power
Current limit	105%		135%	105%		125%	I _{NOM}	Automatic restart
Short circuit current ²	20%		140%	20%		130%	I _{NOM}	

Thermal Characteristics								
Efficiency		78-88%			80-90%			
Shut down temp. — case	90	95	105	90	95	105	°C	Cool and recycle power to restart
Operating temp. — case			85			85	°C	See Thermal Curves

Mechanical Specifications			
Weight ³	22.4 (652)		22.4 (652)
			Ounces (Grams)

Safety Agency Approvals	
UL, CSA, TÜV, VDE, IEC 950, CE Marked for low voltage directive, 73/23/EEC	

Environmental Characteristics/Product Grade Designators	
Storage temperature	-20°C to +100°C (C-grade and E-grade) -55°C to +100°C (I-grade)
Operating temperature (case)	0°C to +85°C (C-grade and E-grade) -30°C to +85°C (I-grade)

EMI / EMC Characteristics (Performed on selected samples representative of the U Series FlatPac product family.)	
Conducted emissions, LISN	EN 55022 and FCC R&R, Part 15, Subpart B, Class B
Electrostatic discharge	IEC 801-2, 1991, Level 4; ±8 kV Contact, ± 15 kV Air Discharge
RF radiated immunity, E-field	IEC 801-3, 1984; 27 MHz to 500 MHz, 3 V/M, CW
Electrical fast transients/burst	EN 61000-4-4, Level 2; ±1 kV,
Surge immunity	EN 61000-4-5, Class 3; ±2 kV Line to Ground, ±1 kV Line to Line

¹ 10 V, 12 V and 15 V outputs, trim range ±10%. Consult factory for wider trim range.

² Output voltages of 5 V or less incorporate foldback current limiting, greater than 5 V incorporate straight line current limiting.

³ For MU, PU series, multiply value by 2; for NU, QU, RU series, multiply value by 3.

Thermal Curves, 5 V Output

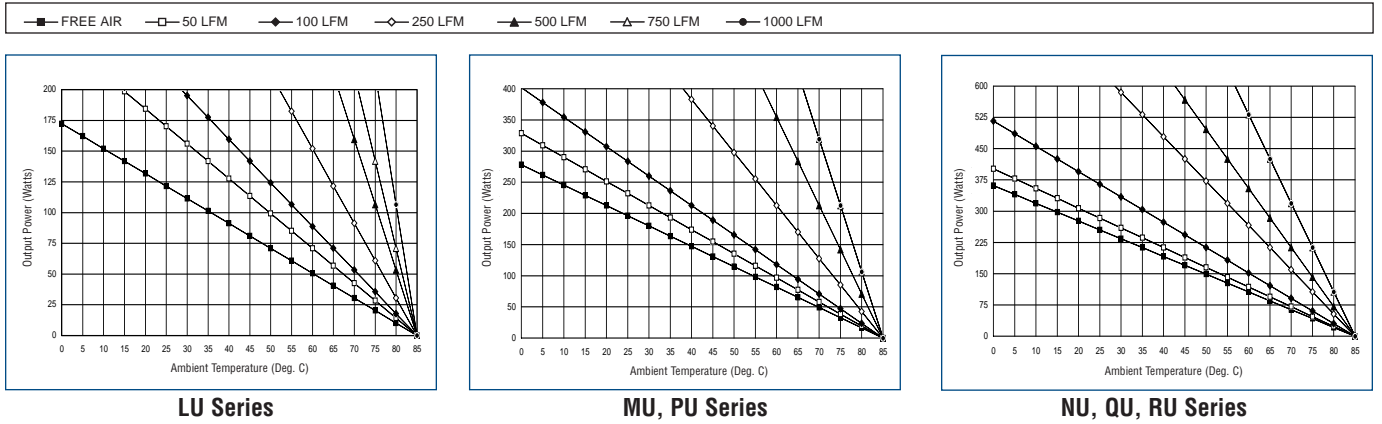

Thermal Curves, 10 to 48 V Output

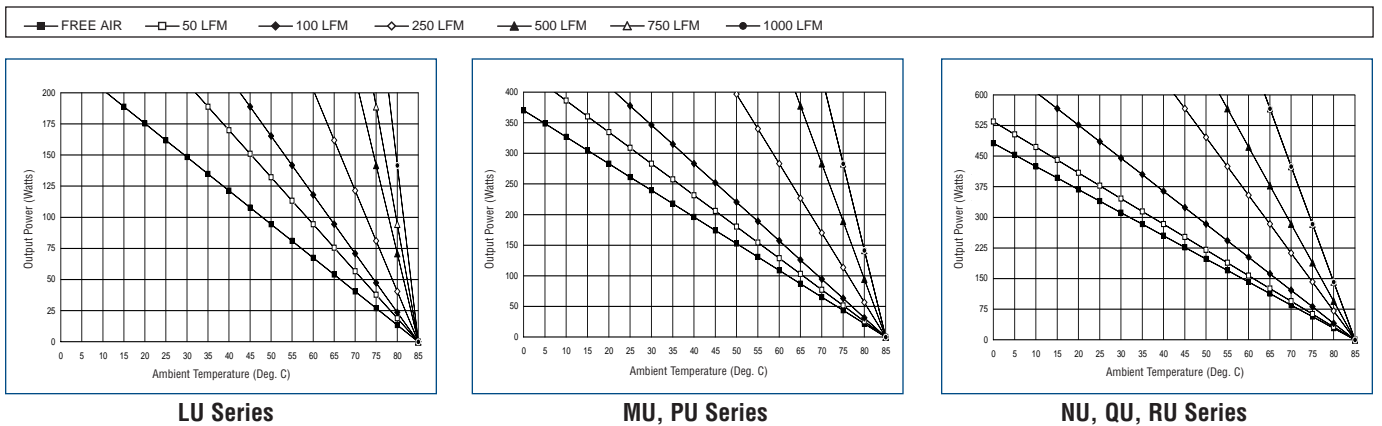

Application Circuits

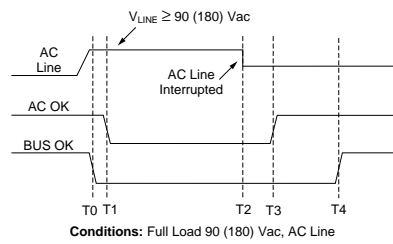
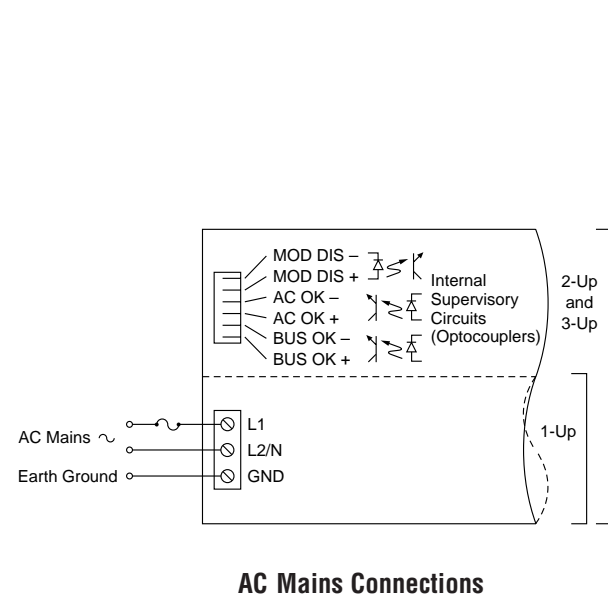

Time Interval	Min	Typ	Max	Units	Notes
T0-T1	0	0.1	1.0	ms	
T2-T3	0	40	-	ms	Ride-through time
T2-T4	5	-	-	ms	Hold-up time
T3-T4	5	-	-	ms	AC fail warning time

Power Up and Power Down Sequencing

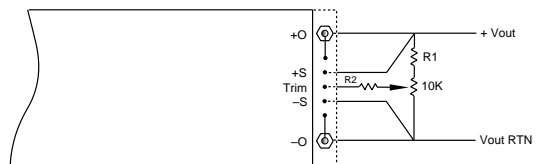

Nom. Output Voltage	Resistor Values for Trimming Standard Output Voltages						Trim Range
	5 V	12 V	15 V	24 V	28 V	48 V	
R1(kΩ)	0.953	15.8	22.1	41.2	48.7	90.9	+10%, -10%
R2(kΩ)	90	90	90	90	90	90	

Output Trimming

Mechanical Drawings

Inputs

- 1 MOD DIS-
 - 2 MOD DIS+
 - 3 AC OK-
 - 4 AC OK+
 - 5 BUS OK-
 - 6 BUS OK+
 - 7 AC IN L1
 - 8 AC IN L2/N
 - 9 CHASSIS GND
- Input connector, Amp P/N 644488-6; mating connector, MTA-100 IDC Series
- Terminals for #16-12 AWG wire

Outputs

- 10 +OUT (#10-32 Stud)
 - 11 +OUT
 - 12 +SENSE (V_{TRIM}^*)
 - 13 TRIM (I_{TRIM}^*)
 - 14 -SENSE (I_{MON}^*)
 - 15 -OUT
 - 16 -OUT (#10-32 Stud)
- Output connector, Amp P/N 644486-5; mating connector, MTA-100 IDC Series

*On FlatPACs with BatMODs only.

All Models

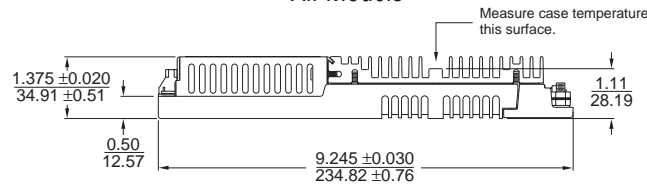

LU Series

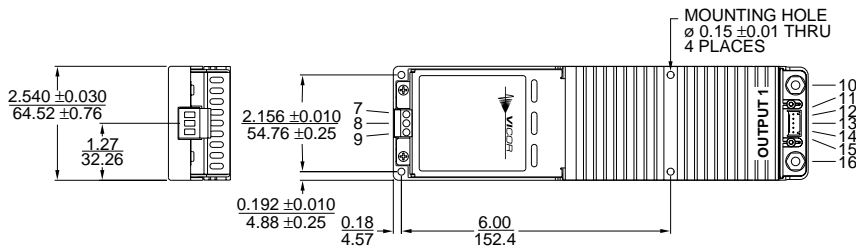

MU, PU Series

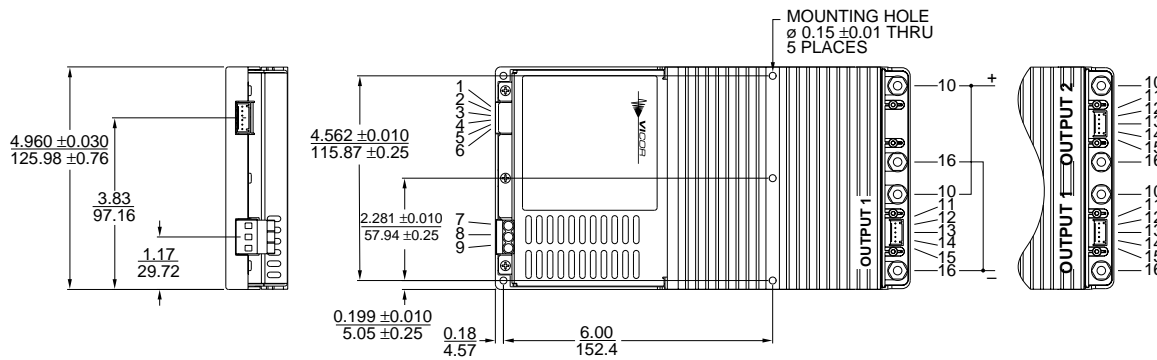

NU, QU, RU Series

