



AKD4340-SB

AK4340 Evaluation Board Rev.0

General Description

AKD4340-SB is an evaluation board for AK4340 (192kHz sampling 24Bit $\Delta\Sigma$ DAC). AKD4340-SB has a digital audio interface (AK4113) of Optical or COAX input and can easily achieve the interface with digital audio system. Therefore, it is easy to evaluate the sound quality of AK4340.

■ **Ordering Guide**

AKD4340-SB ---- AK4340 Evaluation Board

(Cable for connecting with printer port of IBM-AT compatible PC and control software are packed with this. This control software does not operate on Windows NT.)

Function

- On-board digital audio interface. (AK4113)

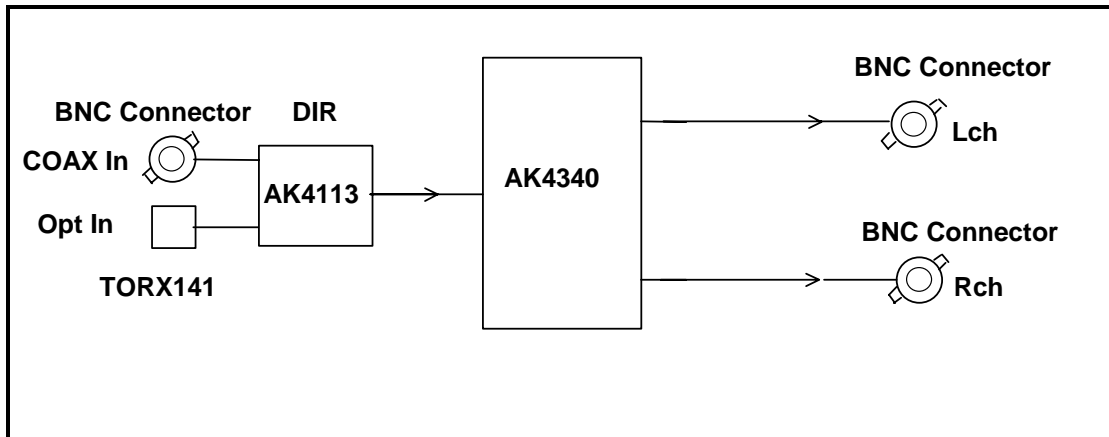

Figure 1. AKD4340-SB Block diagram
 (* Circuit diagram and PCB layout are attached at the end of this manual.)

COAX is recommended for an evaluation of the Sound quality.

■ Operation sequence

1) Set up the power supply lines. (See “Other jumpers set-up”.)

Name of jack	Color of jack	Voltage	Used for	Comments and attention	Default setting
+15V	Red	+12~+15V	Regulator T1, T2	This jack should be always connected to power supply.	+12V
-15V	Blue	-4.5~-13.2V	HVEE of AK4340	This jack should be always connected to power supply.	-5V
AGND	Black	0V	GND	This jack should be always connected to power supply.	0V

Table 1. Set up of power supply lines

Each supply line should be distributed from the power supply unit.

2) Set-up the jumper pins

3) Set-up the DIP switches. (See the followings.)

4) Power on

The AK4340 should be reset once by bringing SW1 (PDN) “L” upon power-up.

■ Evaluation mode

1. Using DIR (COAX) (default)

It is possible to evaluate the AK4340 by using CD disk. The DIR generates MCLK, BICK, LRCK and SDATA from the received data through BNC connector (J1). Setting of jumper is shown below.

COAX is recommended for an evaluation of the Sound quality.

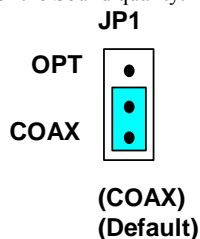

Figure 2. Jumper setting, when using DIR (COAX) (default)

2. Using DIR (Optical Link)

It is possible to evaluate the AK4340 by using CD disk. The DIR generates MCLK, BICK, LRCK and SDATA from the received data through optical connector (PORT3: TORX141). Setting of jumper is shown below.

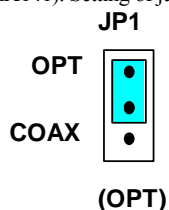

Figure 3. Jumper setting, when using DIR (Optical Link)

3. All clocks are fed through the PORT1.

Change the resistance as below.

R13: 5.1Ω → open

R15, R17, R18: 100Ω → open

R1, R2, R3, R8: open → 100Ω or short (0Ω)

■ DIP Switch setting

[SW2]: AK4113 setting

No.	Pin	OFF	ON	Default
1	OCKS1	AK4113 Master Clock setting		ON
2	OCKS0	Refer to Table4		OFF

Table 2. SW2 setting

[SW3]: AK4340 setting

No.	Pin	OFF	ON	Default
1	SMUTE	Soft Mute pin in Parallel Mode : “Disable”	Soft Mute pin in Parallel Mode : “Enable”	OFF
2	P/S	Parallel Control Mode	Serial Control Mode	OFF
3	ACKS	Manual Setting Mode	Auto Setting Mode	ON
4	GAIN	0dB (2Vrms)	+1.94dB (2.5Vrms)	OFF

Table 3. SW3 setting

The frequency of the master clock output is set by OCKS0 and OCKS1 as shown in Table 4.

OCKS1	OCKS0	MCLK Frequency
0	0	256fs @fs=88.2/96kHz
1	0	512fs @ fs=32/44.1/48kHz
1	1	128fs @ fs=176.4/192kHz

Default

Table 4. MCLK Clock

■ SW1 setting

[SW1](PDN): Reset of AK4340. Select "H" during operation.

Control Software Manual

■ Set-up of evaluation board and control software

1. Set up the AKD4340-SB according to previous term.
2. Connect IBM-AT compatible PC with AKD4340-SB by 10-line type flat cable (packed with AKD4340-SB). Take care of the direction of 10pin header. (Please install the driver in the CD-ROM when this control software is used on Windows 2000/XP. Please refer "Installation Manual of Control Software Driver by AKM device control software". In case of Windows95/98/ME, this installation is not needed. This control software does not operate on Windows NT.)
3. Insert the CD-ROM labeled "AKD4340-SB Evaluation Kit" into the CD-ROM drive.
4. Access the CD-ROM drive and double-click the icon of "akd4340.exe" to set up the control program.
5. Then please evaluate according to the follows.

■ Operation flow

Keep the following flow.

1. Set up the control program according to explanation above.
2. Click "Port Reset" button.

■ Explanation of each buttons

- | | |
|---------------------|---|
| 1. [Port Reset]: | Set up the USB interface board (AKDUSBIF-A). |
| 2. [Write default]: | Initialize the register of AK4340. |
| 3. [All Write]: | Write all registers that is currently displayed. |
| 4. [Function1]: | Dialog to write data by keyboard operation. |
| 5. [Function2]: | Dialog to write data by keyboard operation. |
| 6. [Function3]: | The sequence of register setting can be set and executed. |
| 7. [Function4]: | The sequence that is created on [Function3] can be assigned to buttons and executed. |
| 8. [Function5]: | The register setting that is created by [SAVE] function on main window can be assigned to buttons and executed. |
| 9. [SAVE]: | Save the current register setting. |
| 10. [OPEN]: | Write the saved values to all register. |
| 11. [Write]: | Dialog to write data by mouse operation. |

■ Indication of data

Input data is indicated on the register map. Red letter indicates "H" or "1" and blue one indicates "L" or "0". Blank is the part that is not defined in the datasheet.

■ Explanation of each dialog

1. [Write Dialog]: Dialog to write data by mouse operation

There are dialogs corresponding to each register.

Click the [Write] button corresponding to each register to set up the dialog. If you check the check box, data becomes “H” or “1”. If not, “L” or “0”.

When writing the input data to AK4340, click [OK] button. If not, click [Cancel] button.

2. [Function1 Dialog]: Dialog to write data by keyboard operation

Address Box:	Input registers address in 2 figures of hexadecimal.
Data Box:	Input registers data in 2 figures of hexadecimal.

When writing the input data to AK4340, click [OK] button. If not, click [Cancel] button.

3. [Function2 Dialog]: Dialog to evaluate ATT

Address Box:	Input registers address in 2 figures of hexadecimal.
Start Data Box:	Input starts data in 2 figures of hexadecimal.
End Data Box:	Input end data in 2 figures of hexadecimal.
Interval Box:	Data is written to AK4340 by this interval.
Step Box:	Data changes by this step.
Mode Select Box:	

With checking this check box, data reaches end data, and returns to start data.

[Example] Start Data = 00, End Data = 09

Data flow: 00 01 02 03 04 05 06 07 08 09 09 08 07 06 05 04 03 02 01 00

Without checking this check box, data reaches end data, but does not return to start data.

[Example] Start Data = 00, End Data = 09

Data flow: 00 01 02 03 04 05 06 07 08 09

When writing the input data to AK4340, click [OK] button. If not, click [Cancel] button.

4. [Save] and [Open]

4-1. [Save]

Save the current register setting data. The extension of file name is “akr”.

(Operation flow)

- (1) Click [Save] Button.
- (2) Set the file name and push [Save] Button. The extension of file name is “akr”.

4-2. [Open]

The register setting data saved by [Save] is written to AK4340. The file type is the same as [Save].

(Operation flow)

- (1) Click [Open] Button.
- (2) Select the file (*.akr) and Click [Open] Button.

5. [Function3 Dialog]

The sequence of register setting can be set and executed.

(1) Click [F3] Button.

(2) Set the control sequence.

Set the address, Data and Interval time. Set “-1” to the address of the step where the sequence should be paused.

(3) Click [Start] button. Then this sequence is executed.

The sequence is paused at the step of Interval="-1". Click [START] button, the sequence restarts from the paused step.

This sequence can be saved and opened by [Save] and [Open] button on the [Function3] window. The extension of file name is “aks”.

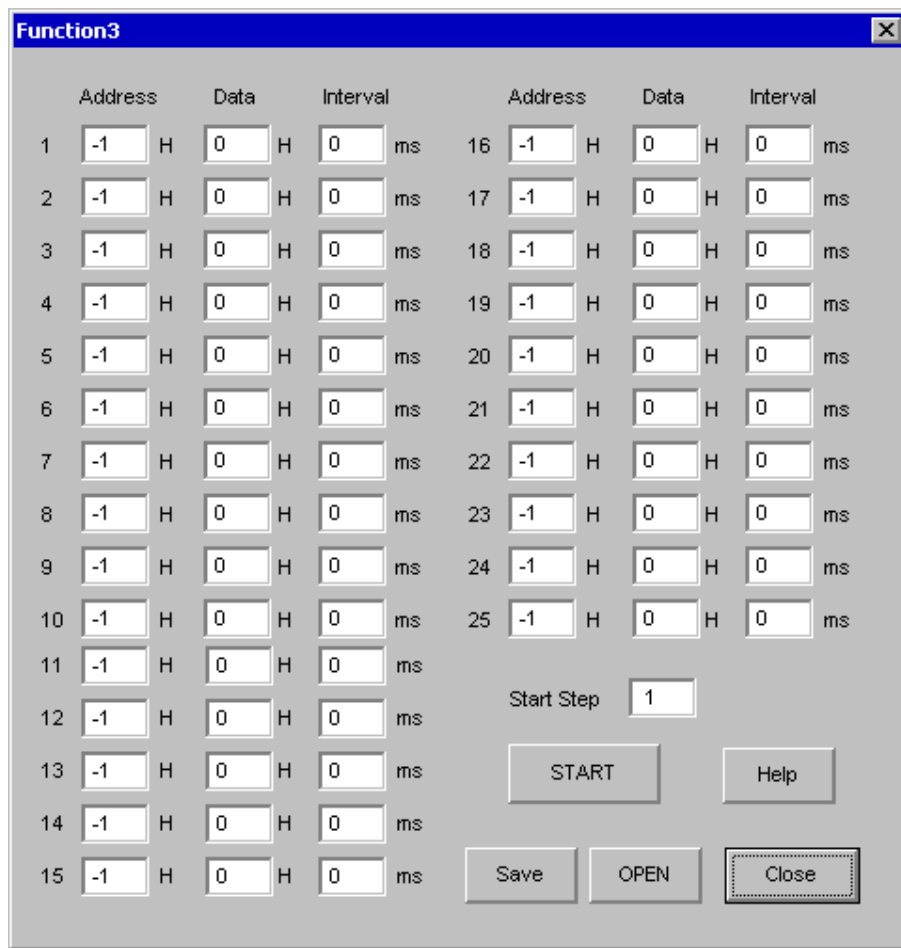

Figure 4. Window of [F3]

6. [Function4 Dialog]

The sequence that is created on [Function3] can be assigned to buttons and executed. When [F4] button is clicked, the window as shown in Figure 5 opens.

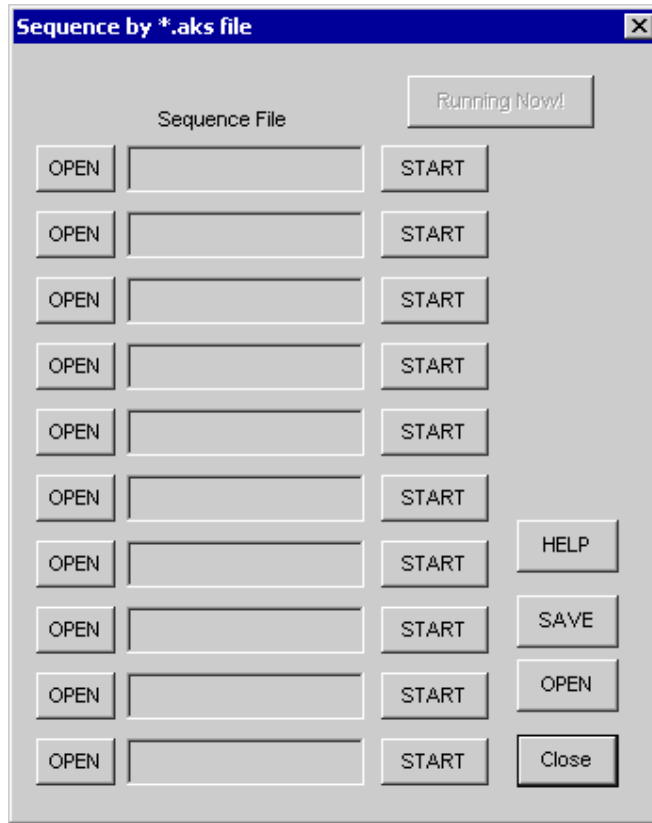

Figure 5. [F4] window

6-1. [OPEN] buttons on left side and [START] buttons

(1) Click [OPEN] button and select the sequence file (*.aks).

The sequence file name is displayed as shown in Figure 6.

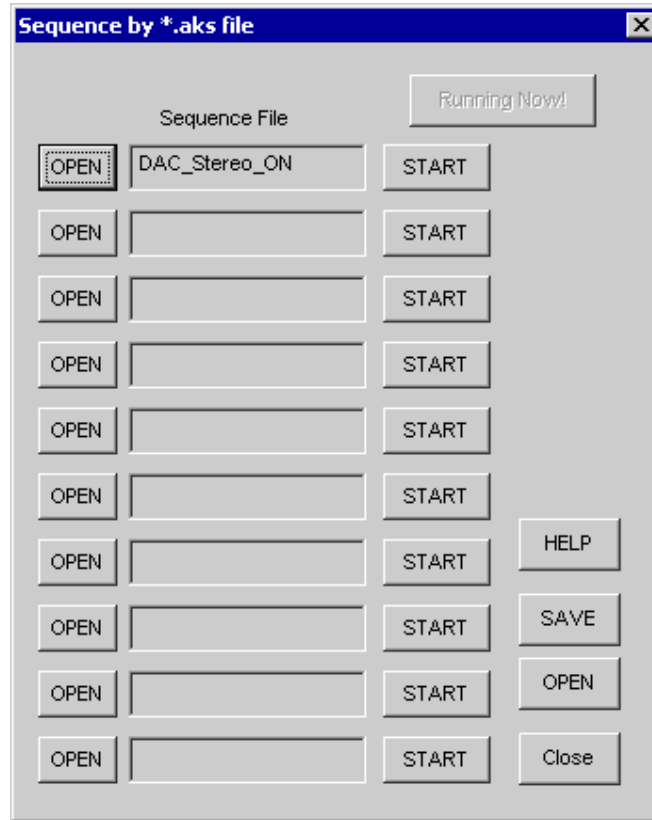

Figure 6. [F4] window(2)

(2) Click [START] button, then the sequence is executed.

6-2. [SAVE] and [OPEN] buttons on right side

[SAVE]: The sequence file names can assign be saved. The file name is *.ak4.

[OPEN]: The sequence file names assign that are saved in *.ak4 are loaded.

6-3. Note

- (1) [Function4] doesn't support the pause function of sequence function.
- (2) All files need to be in same folder used by [SAVE] and [OPEN] function on right side.
- (3) When the sequence is changed in [Function3], the file should be loaded again in order to reflect the change.

7. [Function5 Dialog]

The register setting that is created by [SAVE] function on main window can be assigned to buttons and executed. When [F5] button is clicked, the following window as shown in Figure 7 opens.

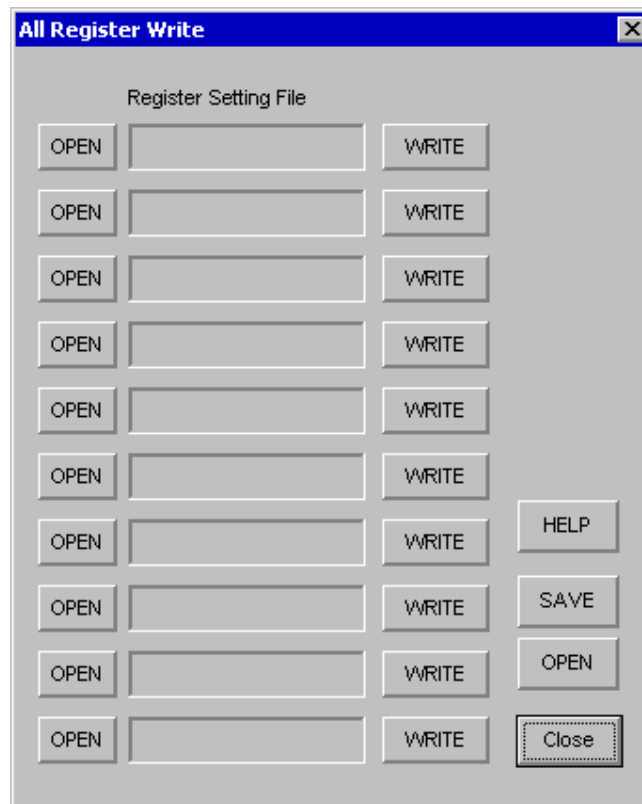

Figure 7. [F5] window

7-1. [OPEN] buttons on left side and [WRITE] button

- (1) Click [OPEN] button and select the register setting file (*.akr).
- (2) Click [WRITE] button, then the register setting is executed.

7-2. [SAVE] and [OPEN] buttons on right side

[SAVE]: The register setting file names assign can be saved. The file name is *.ak5.

[OPEN]: The register setting file names assign that are saved in *.ak5 are loaded.

7-3. Note

- (1) All files need to be in same folder used by [SAVE] and [OPEN] function on right side.
- (2) When the register setting is changed by [Save] Button in main window, the file should be loaded again in order to reflect the change.

Measurement Result

[Measurement condition]

- Measurement unit : Audio Precision SYS-2722 (192K)
- MCLK : 512fs (fs=44.1kHz), 256fs (fs=96KHz), 128fs (fs=192KHz)
- BICK : 64fs
- fs : 44.1kHz, 96KHz, 192KHz
- BW : 20Hz~20kHz (fs=44.1kHz), 20Hz~40kHz (fs=96kHz, 192KHz)
- Resolution : 24bit
- Power Supply : VDD=+5V, HVVE=-5V
- Interface : AK4113 (fs=44.1kHz, 96KHz, 192KHz)
- Temperature : Room Temp
- GAIN : L

fs=44.1kHz

Parameter	Input signal	Measurement filter	Lch Results	Rch Results
S/(N+D)	1kHz, 0dB	20kLPF	90.7 dB	92.2 dB
S/(N+D)	1kHz, -60dB	20kLPF	42.6 dB	42.6 dB
DR	1kHz, -60dB	20kLPF, A-weighted	105.3 dB	105.2 dB
S/N	"0" data	20kLPF, A-weighted	105.6 dB	105.6 dB

fs=96kHz

Parameter	Input signal	Measurement filter	Lch Results	Rch Results
S/(N+D)	1kHz, 0dB	40kLPF	90.4 dB	91.7 dB
S/(N+D)	1kHz, -60dB	40kLPF	40.7 dB	40.8 dB
DR	1kHz, -60dB	40kLPF, A-weighted	105.8 dB	105.6 dB
S/N	"0" data	40kLPF, A-weighted	106.2 dB	106.2 dB

fs=192kHz

Parameter	Input signal	Measurement filter	Lch Results	Rch Results
S/(N+D)	1kHz, 0dB	40kLPF	90.2 dB	91.4 dB
S/(N+D)	1kHz, -60dB	40kLPF	39.2 dB	39.4 dB
DR	1kHz, -60dB	40kLPF, A-weighted	104.3 dB	104.3 dB
S/N	"0" data	40kLPF, A-weighted	105.9 dB	105.8 dB

■ Plots

[Measurement Condition]

- Measurement Unit : Audio Precision SYS-2722 (192KHz)
- MCLK : 512fs (fs=44.1kHz), 256fs (fs=96kHz), 128fs (fs=192kHz)
- BICK : 64fs
- fs : 44.1kHz, 96kHz, 192kHz
- BW : 20Hz~20kHz (fs=44.1kHz), 40Hz~40kHz (fs=96kHz), 80Hz~80kHz (fs=192kHz)
- Resolution : 24bit
- Power Supply : VDD=+5V, HVEE=-5V
- Interface : AK4113 (44.1kHz, 96kHz, 192kHz)
- Temperature : Room Temp
- GAIN : L

fs=48kHz

- Figure 8. FFT (Input Frequency =1kHz, Input Level =0dBFS)
- Figure 9. FFT (Input Frequency =1kHz, Input Level =-60dBFS)
- Figure 10. FFT (noise floor)
- Figure 11. FFT (out-of-band noise)
- Figure 12. THD+N vs Input Level (Input Frequency =1kHz)
- Figure 13. THD+N vs Input Frequency (Input Level=0dBFS)
- Figure 14. Linearity (Input Frequency =1kHz)
- Figure 15. Frequency Response (Input Level=0dBFS)
- Figure 16. Cross-talk (Input Level=0dBFS)

fs=96kHz

- Figure 17. FFT (Input Frequency =1kHz, Input Level =0dBFS)
- Figure 18. FFT (Input Frequency =1kHz, Input Level =0dBFS,Notch-on)
- Figure 19. FFT (Input Frequency =1kHz, Input Level =-60dBFS)
- Figure 20. FFT (noise floor)
- Figure 21. FFT (out-of-band noise)
- Figure 22. THD+N vs Input Level (Input Frequency =1kHz)
- Figure 23. THD+N vs f_{in} (Input Level=0dBFS)
- Figure 24. Linearity (Input Frequency =1kHz)
- Figure 25. Frequency Response (Input Level=0dBFS)
- Figure 26. Cross-talk (Input Level=0dBFS)

fs=192kHz

- Figure 27. FFT (Input Frequency =1kHz, Input Level =0dBFS)
- Figure 28. FFT (Input Frequency =1kHz, Input Level =0dBFS,Notch-on)
- Figure 29. FFT (Input Frequency =1kHz, Input Level =-60dBFS)
- Figure 30. FFT (noise floor)
- Figure 31. FFT (out-of-band noise)
- Figure 32. THD+N vs Input Level (Input Frequency =1kHz)
- Figure 33. THD+N vs f_{in} (Input Level=0dBFS)
- Figure 34. Linearity (Input Frequency =1kHz)
- Figure 35. Frequency Response (Input Level=0dBFS)
- Figure 36. Cross-talk (Input Level=0dBFS)

FFT point=16384, Avg=8, Window=Equiripple

(DAC fs=44.1kHz)

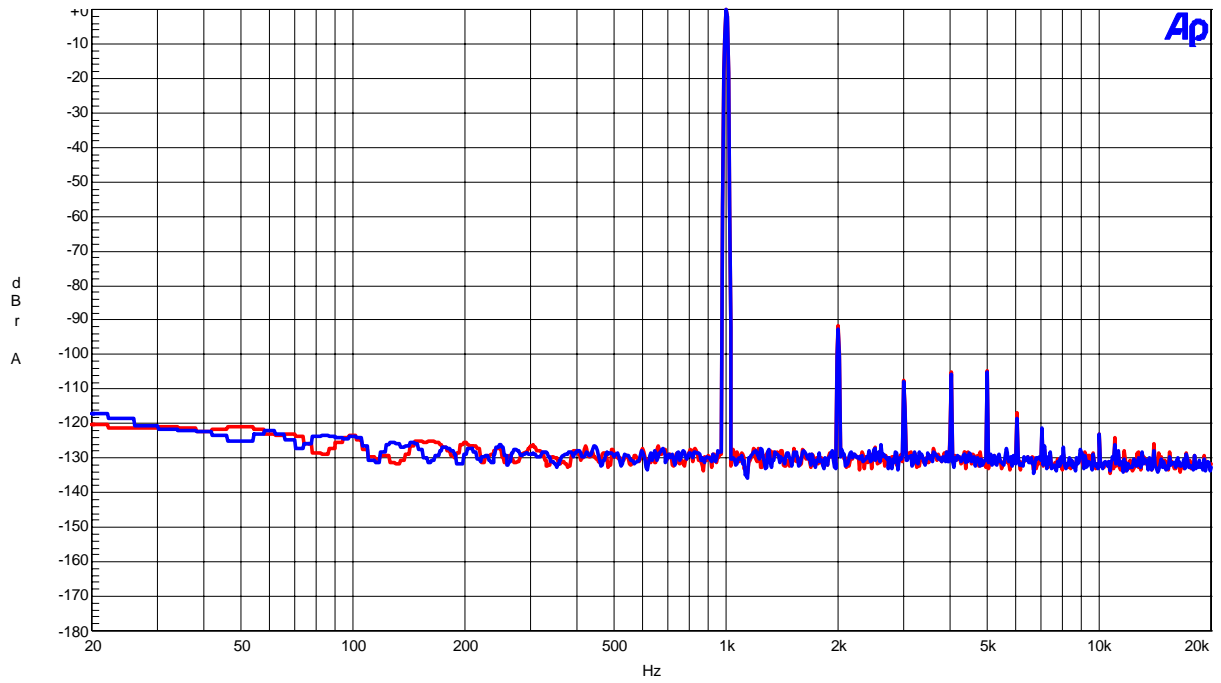

Figure 8. FFT(Input Frequency=1kHz, Input Level=0dBFS)

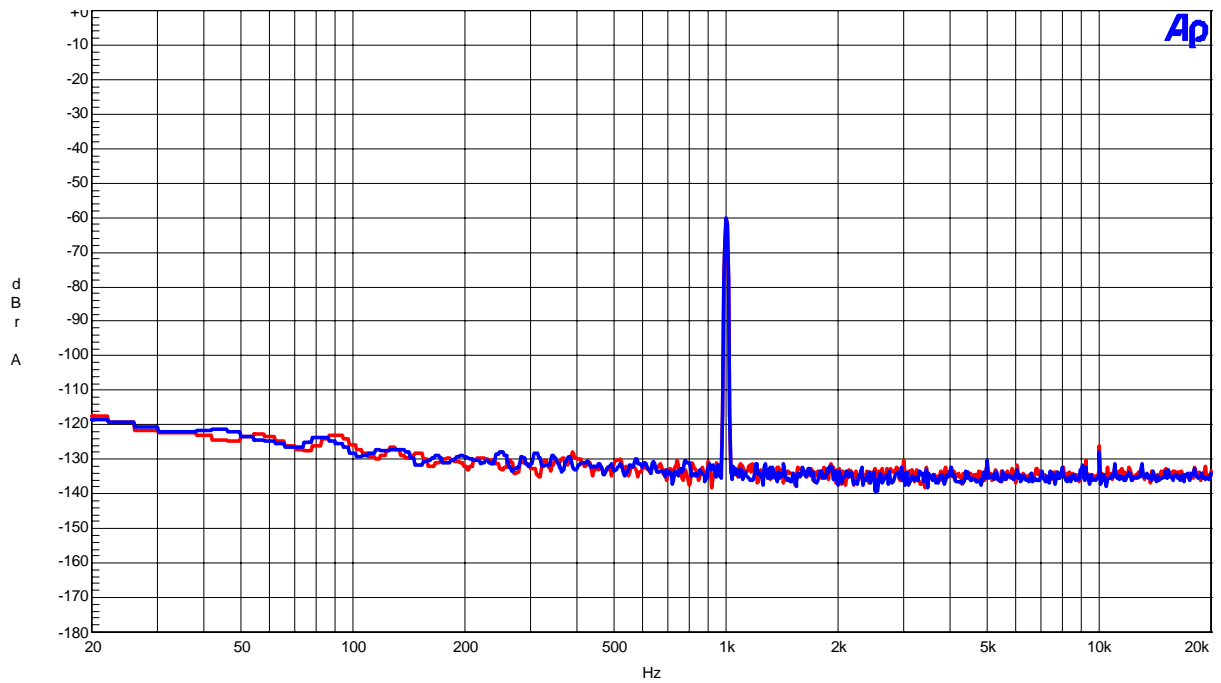

Figure 9. FFT(Input Frequency=1kHz, Input Level=-60dBFS)

(DAC fs=44.1kHz)

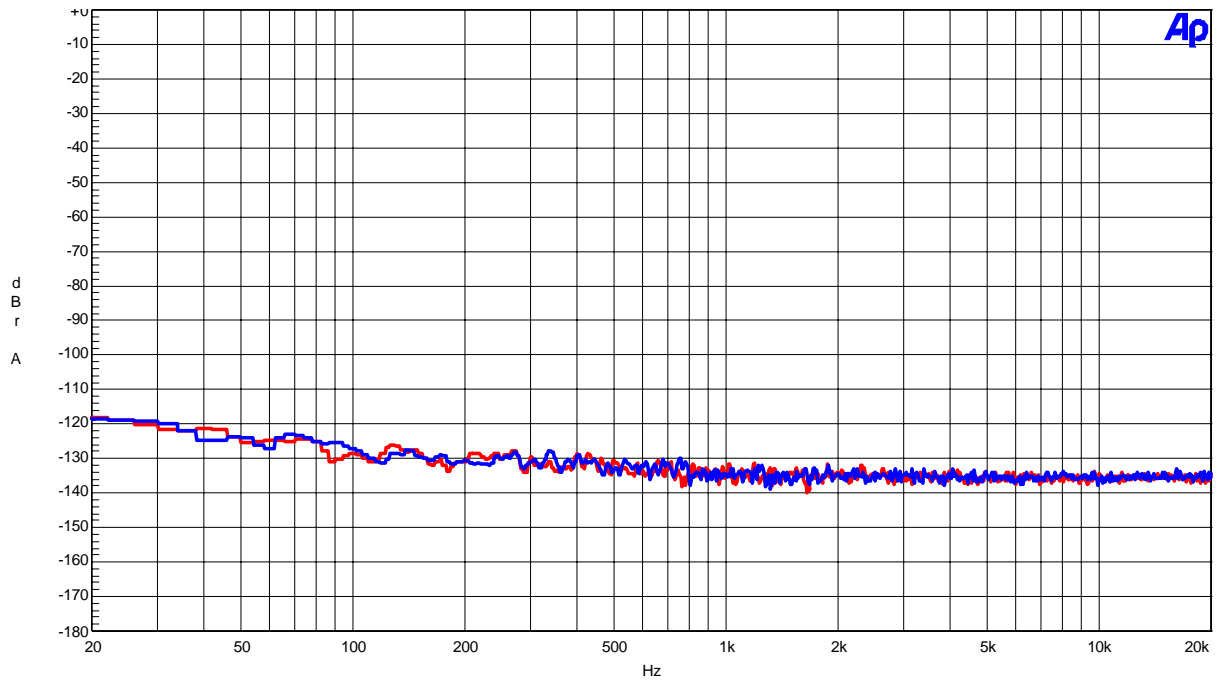

Figure 10. FFT(noise floor)

Red=Lch,Blue=Rch

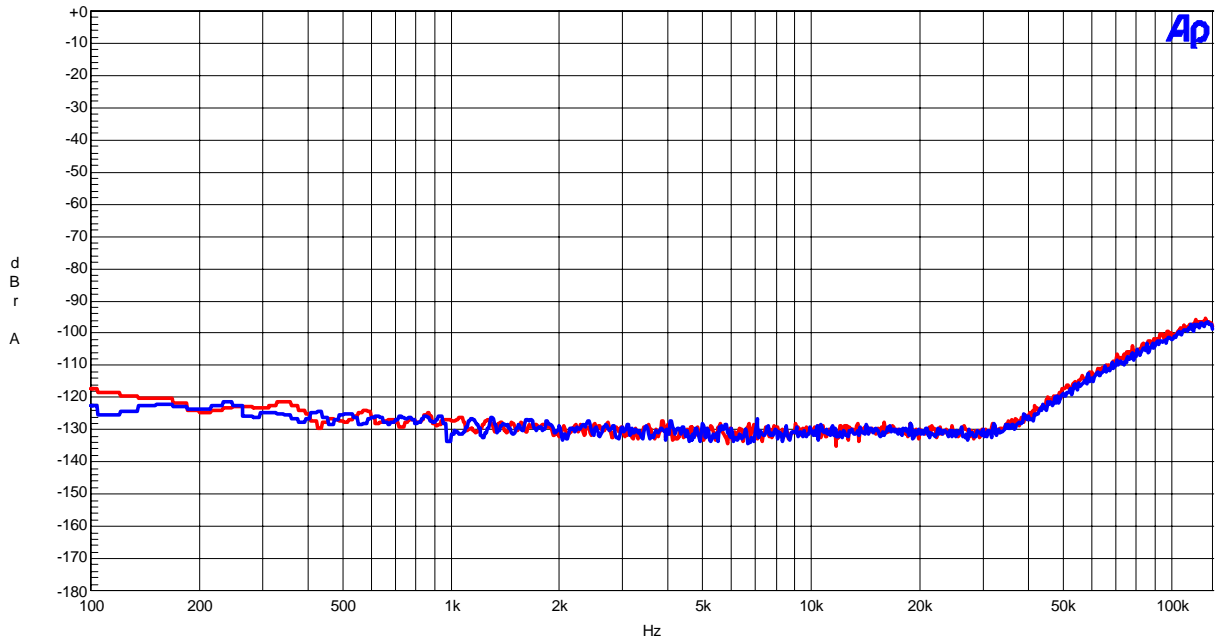

Figure 11. FFT(out-of-band noise)

(DAC fs=44.1kHz)

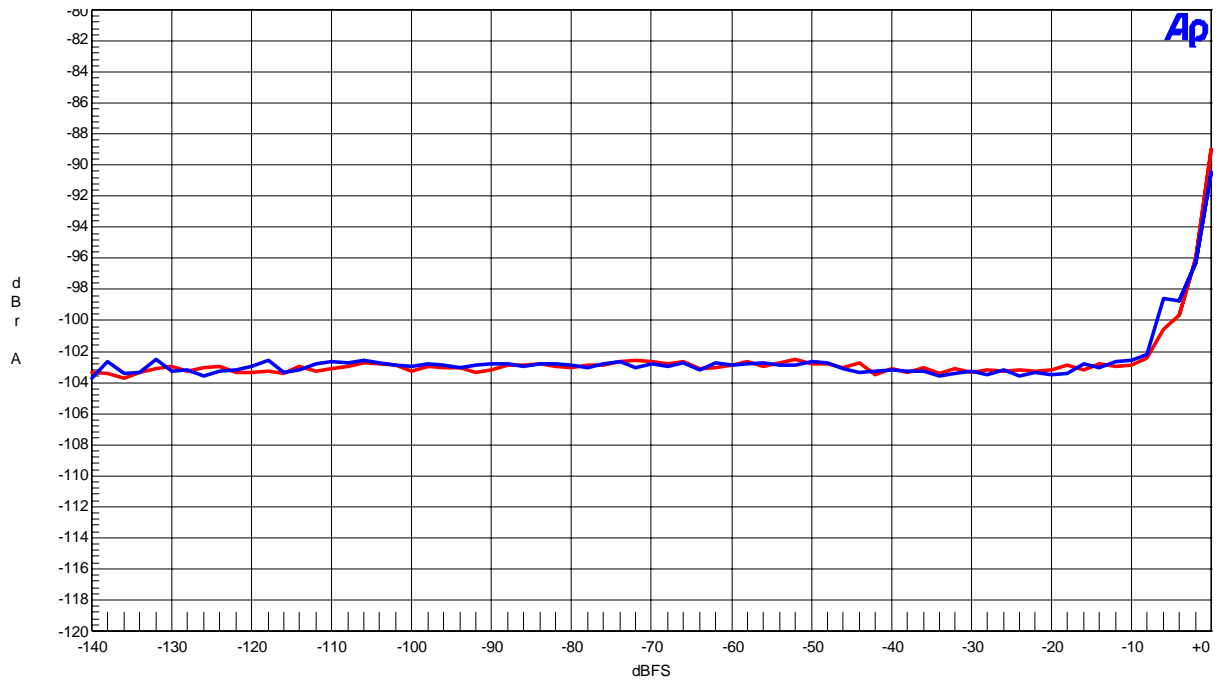

Figure 12. THD+N vs Input Level (Input Frequency=1kHz)

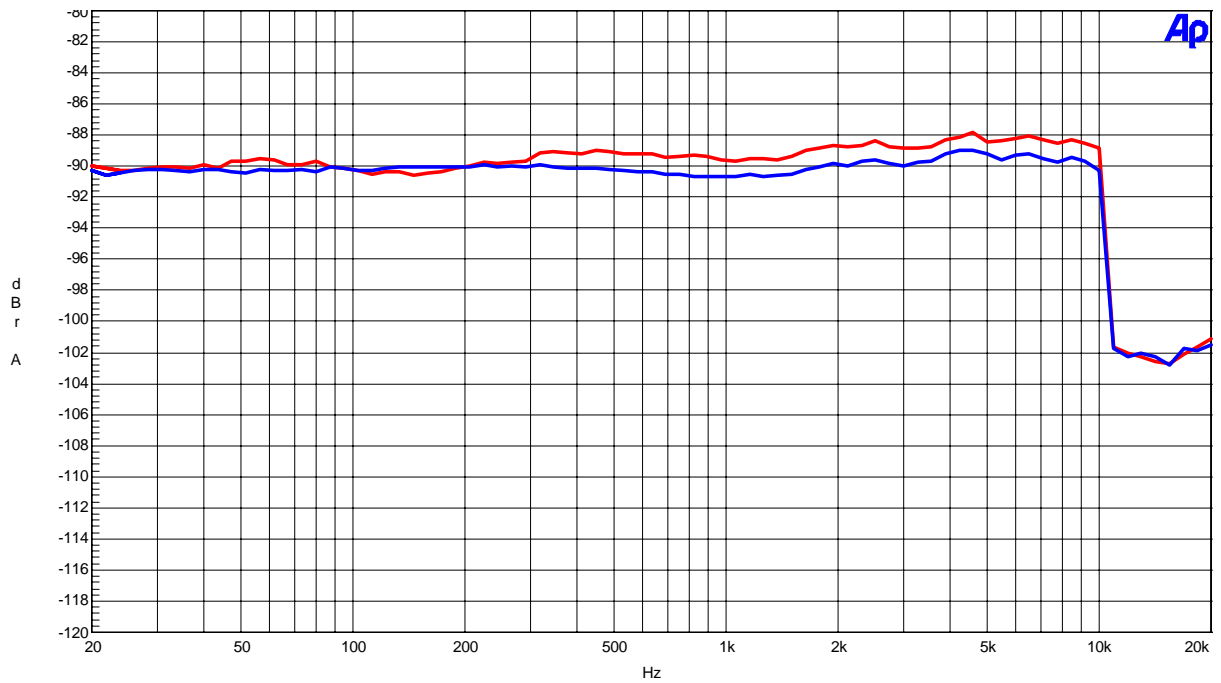

Figure 13. THD+N vs Input Frequency (Input Level=0dBFS)

(DAC $f_s=44.1\text{kHz}$)

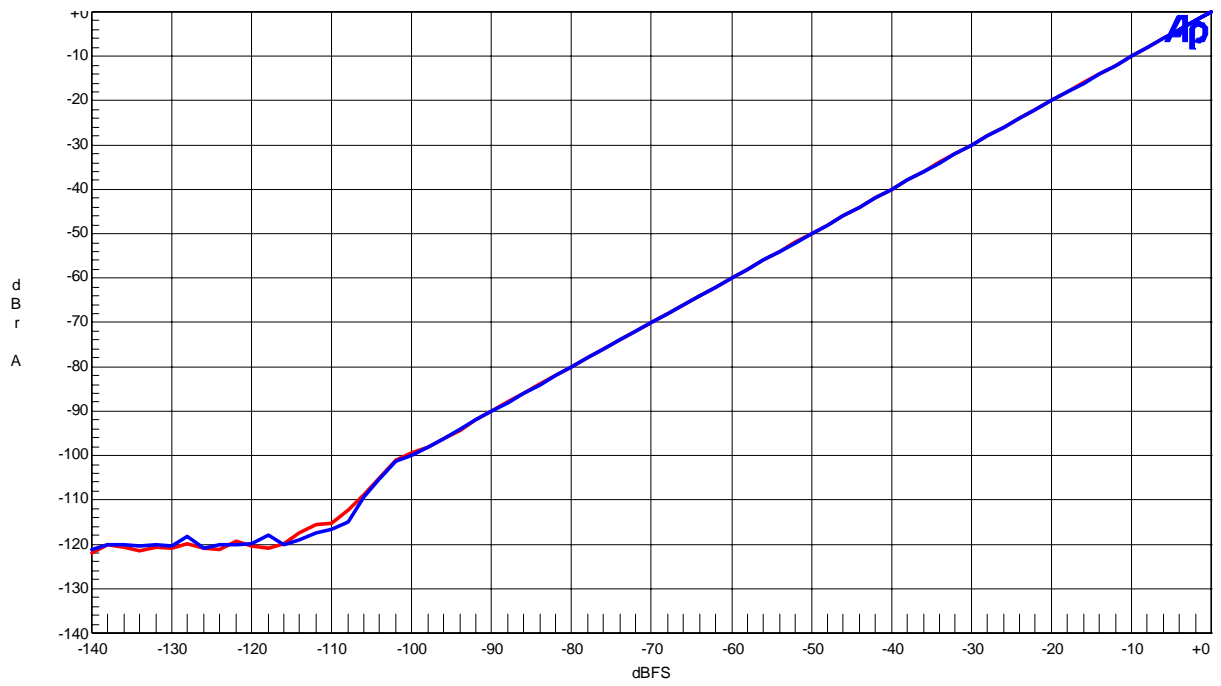

Figure 14. Linearity (Input Frequency=1kHz)

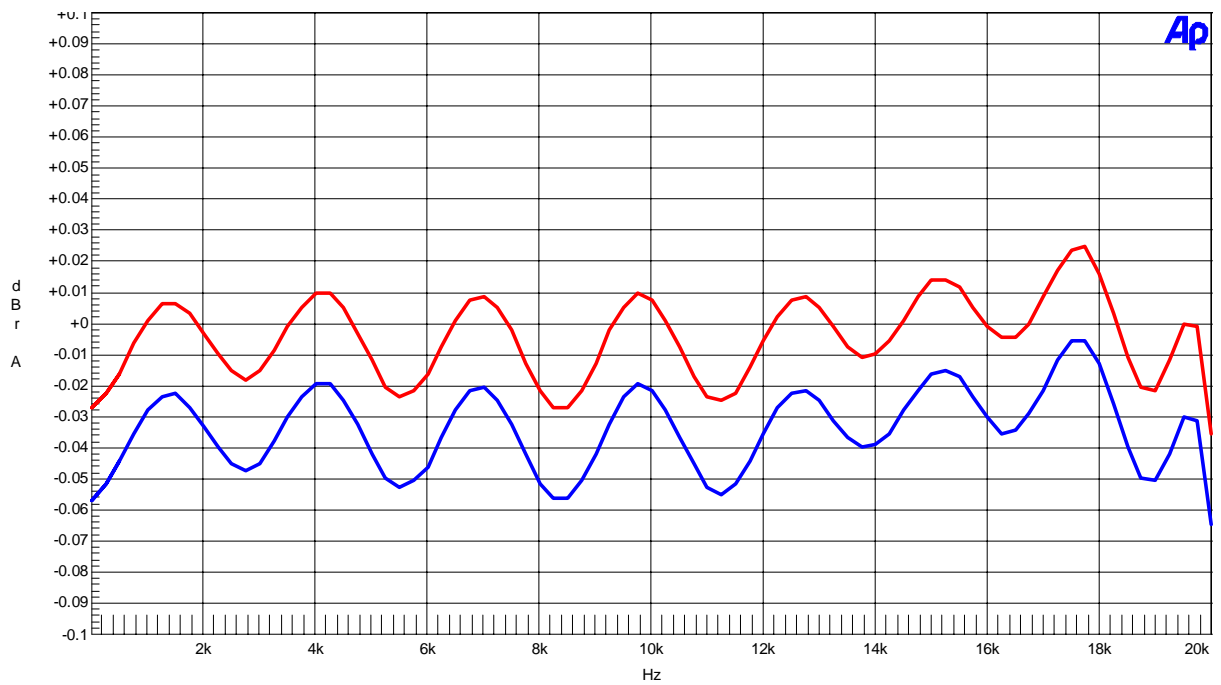

Figure 15. Frequency Response AOUTL Pin / AOUTR Pin (Input Level=0dBFS)

(DAC fs=44.1kHz)

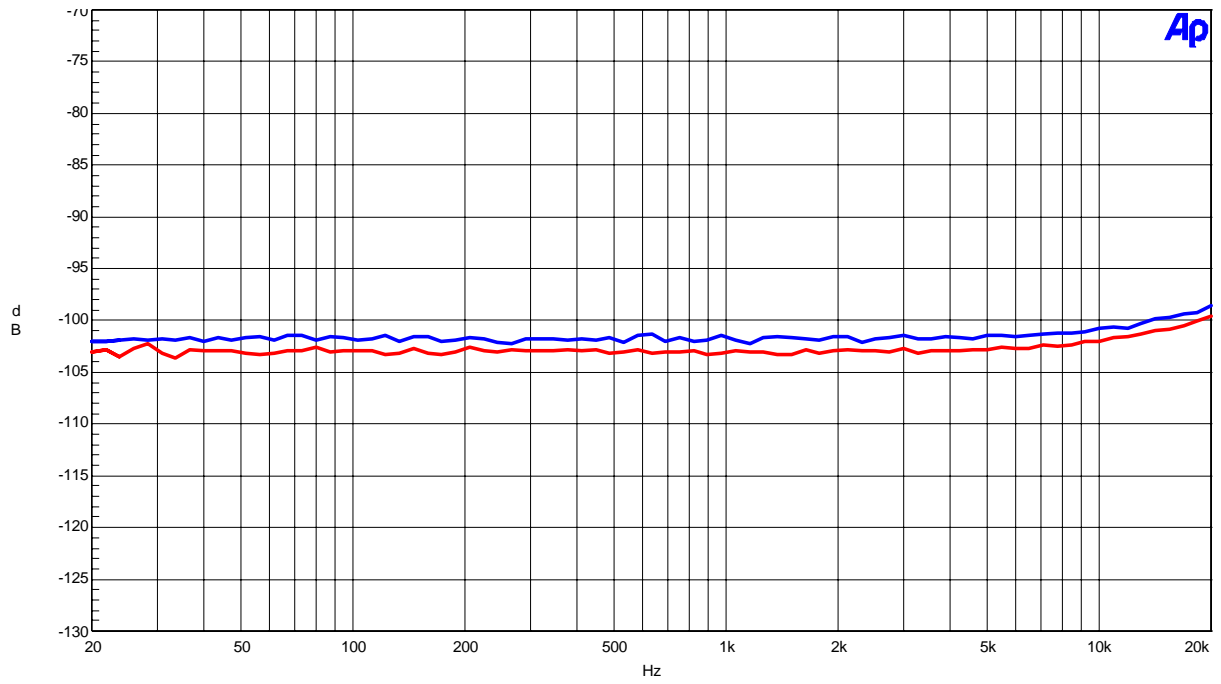

Figure 16. Cross-talk (Input Level=0dBFS)

(DAC fs=96kHz)

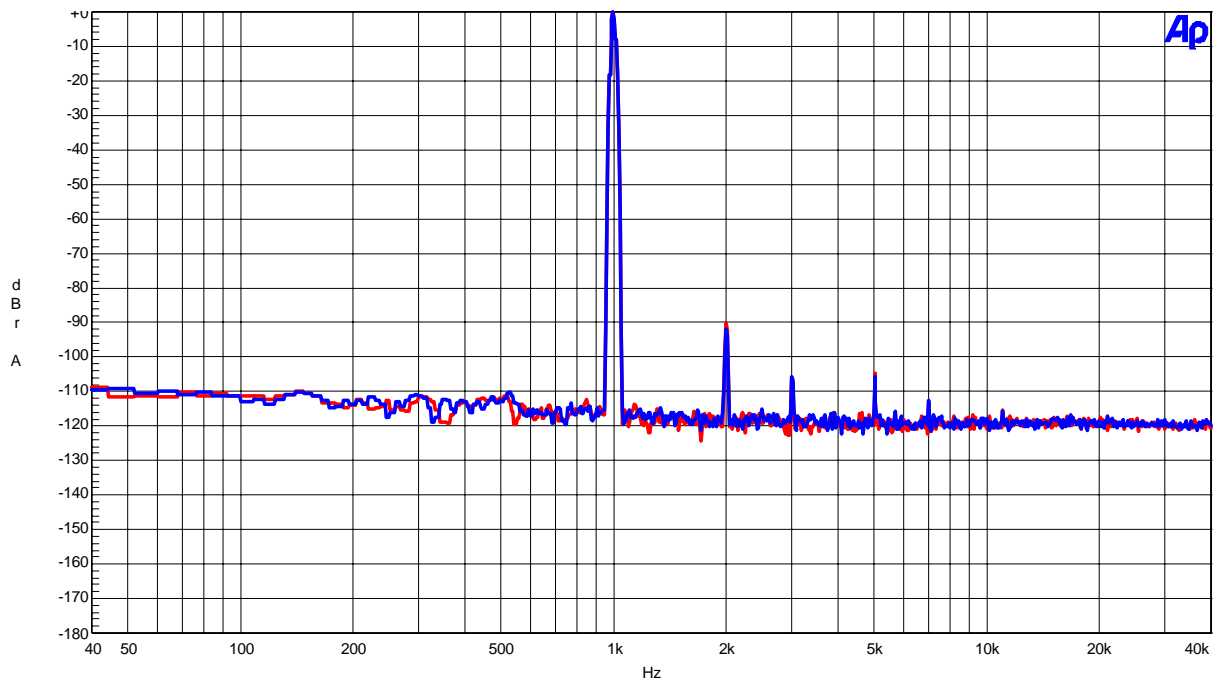

Figure 17. FFT(Input Frequency=1kHz, Input Level=0dBFS)

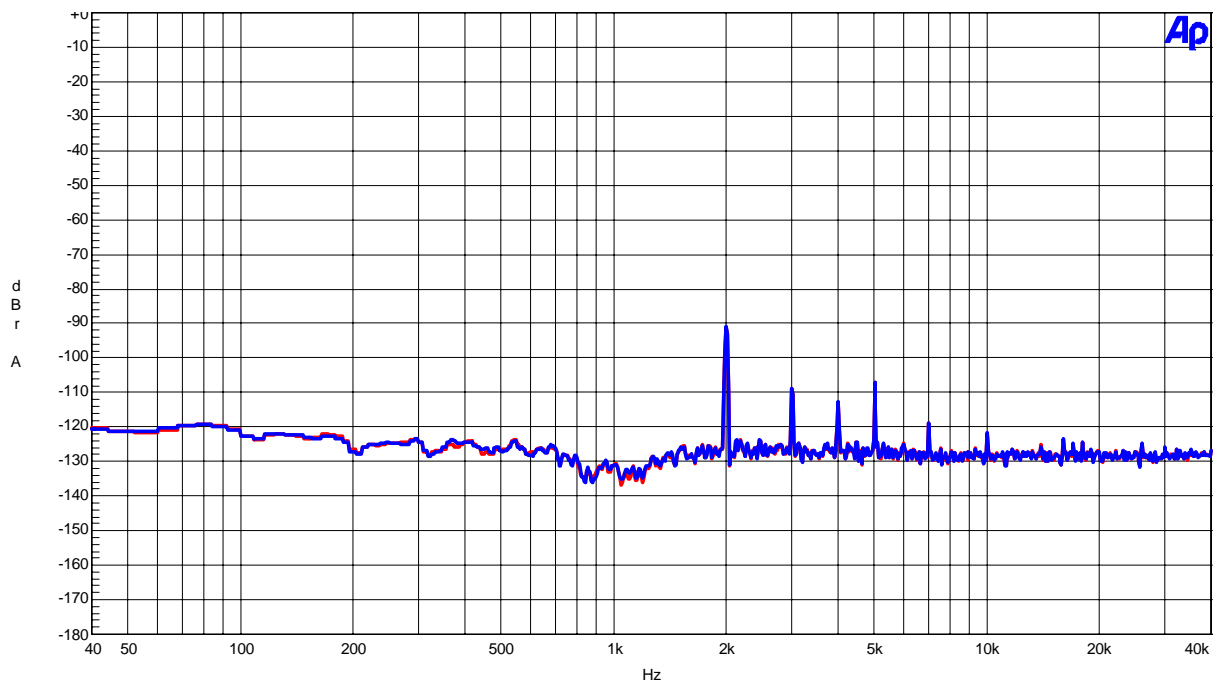

Figure 18. FFT(Input Frequency=1kHz, Input Level=0dBFS,Notch-on)

(DAC fs=96kHz)

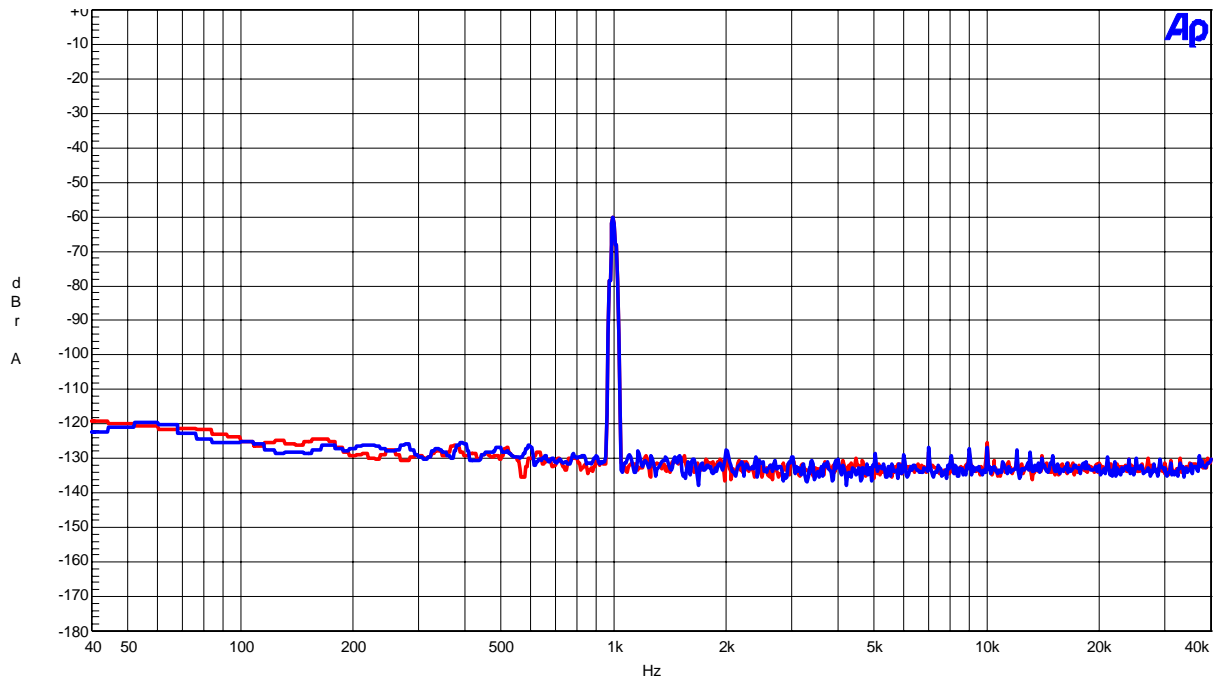

Figure 19. FFT(Input Frequency=1kHz, Input Level=-60dBFS)

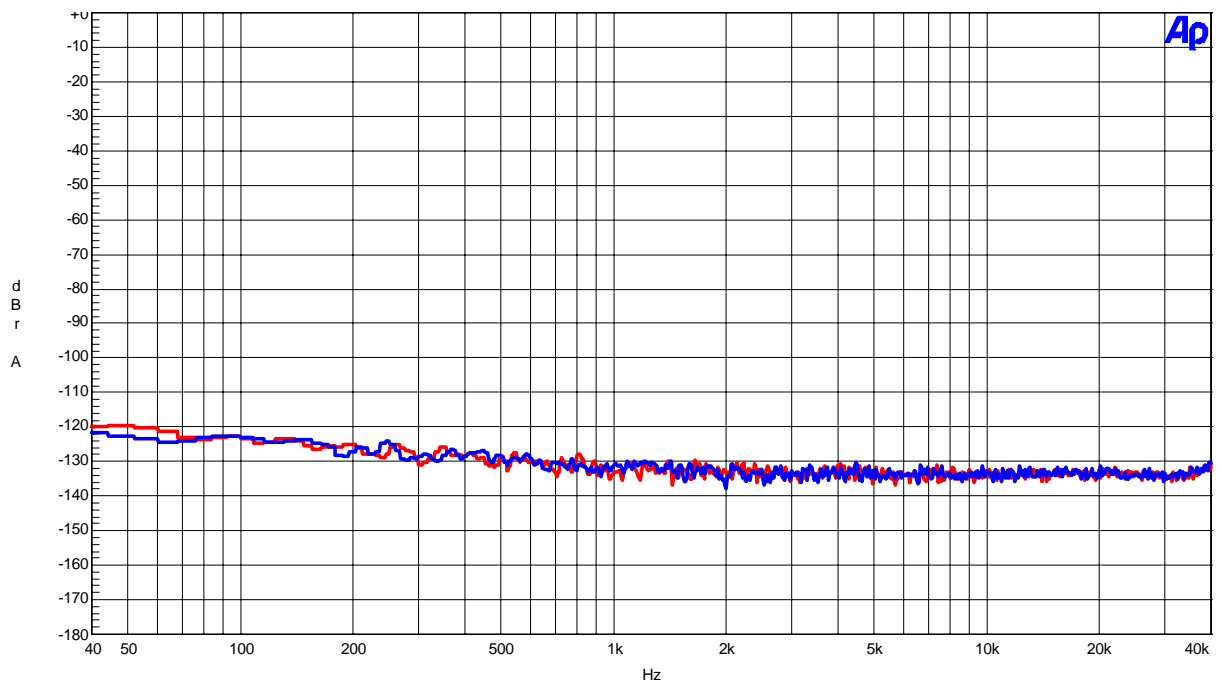

Figure 20. FFT(noise floor)

(DAC fs=96kHz)

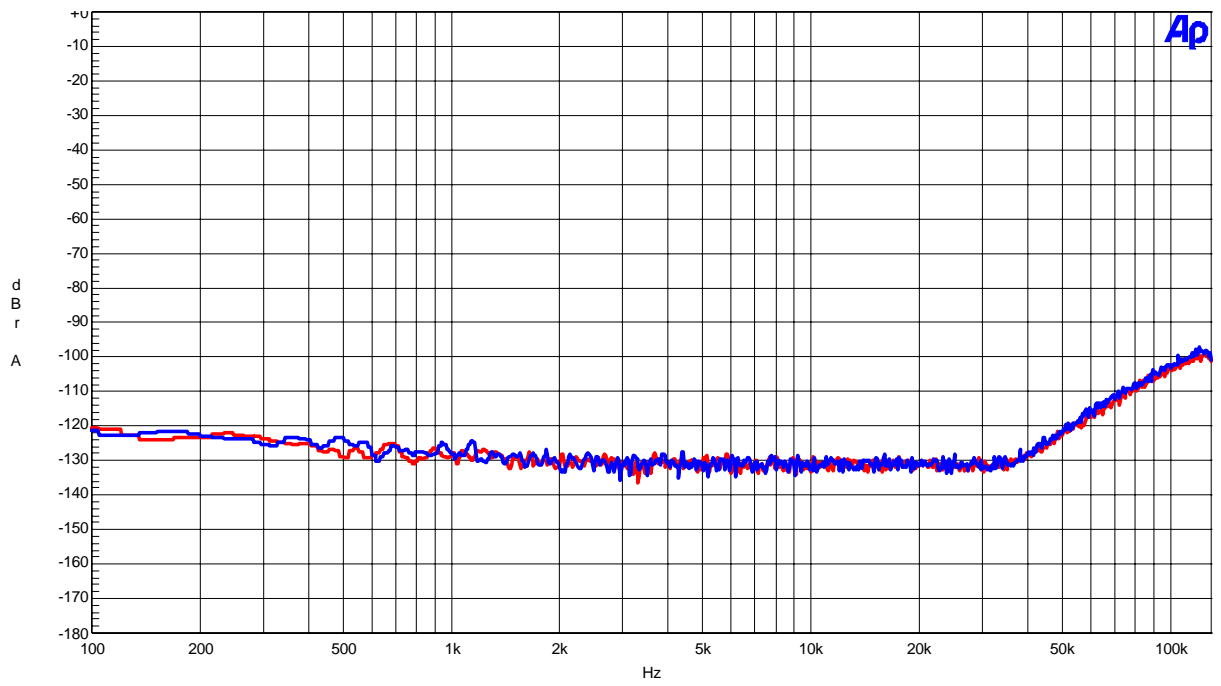

Figure 21. FFT (out-of-band noise)

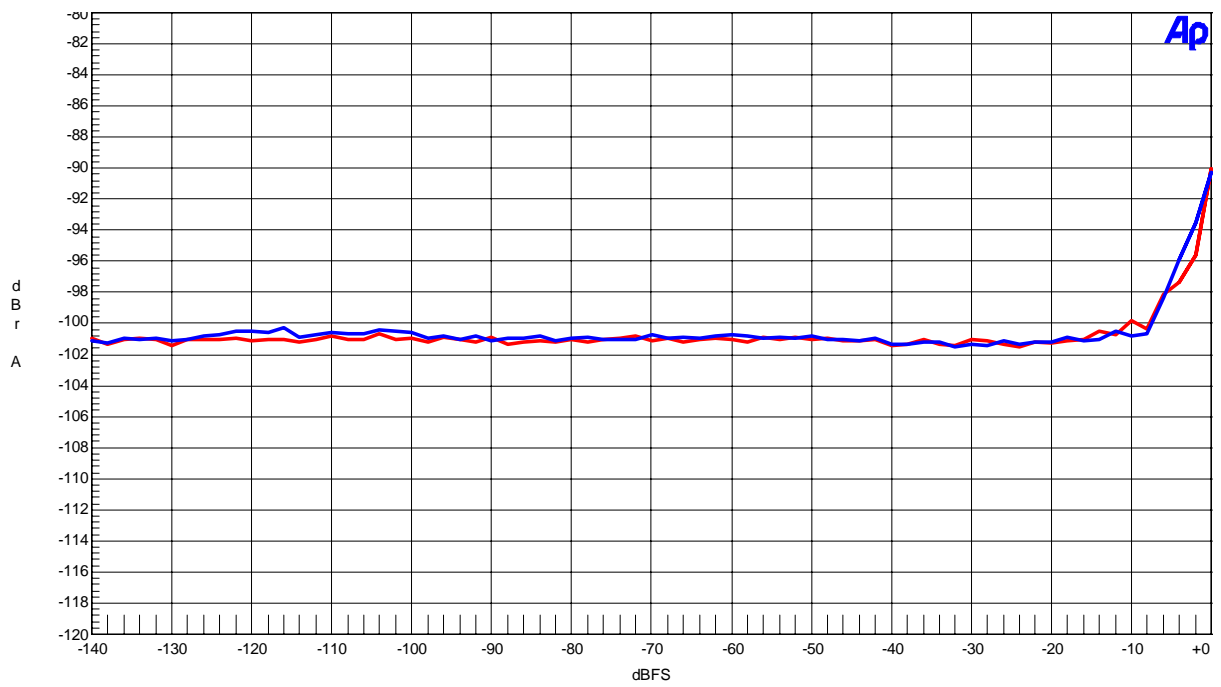

Figure 22. THD+N vs Input Level (Input Frequency=1kHz)

(DAC fs=96kHz)

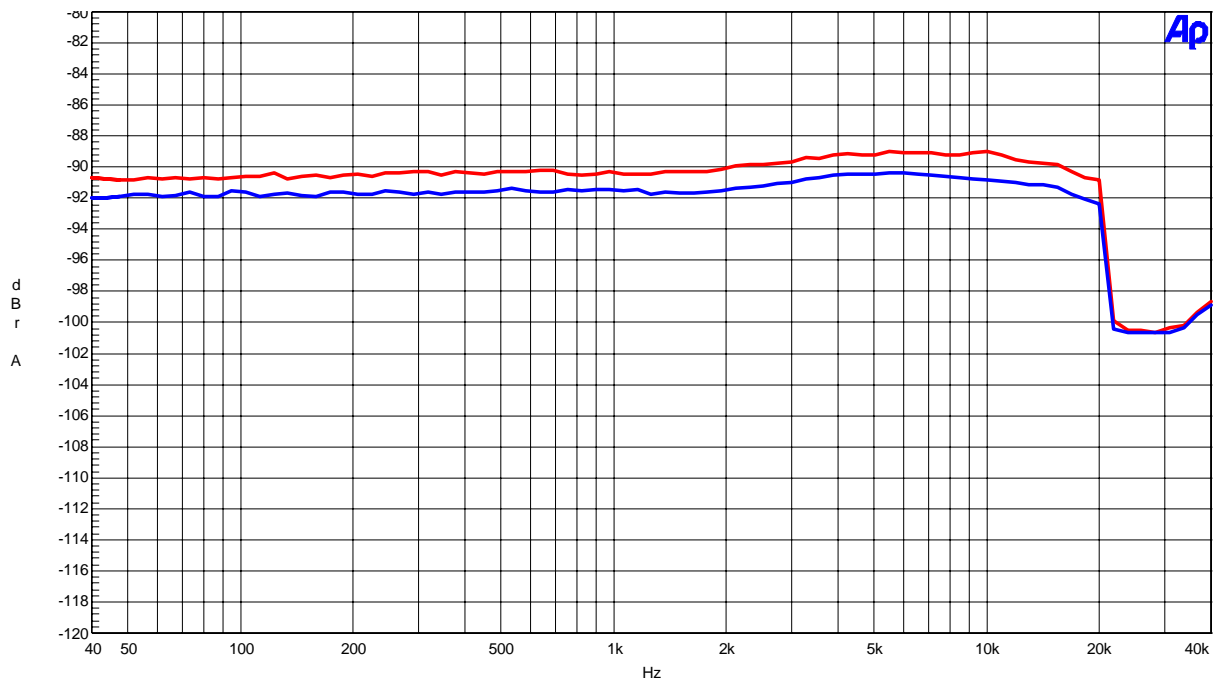

Figure 23. THD+N vs Input Frequency (Input Level=0dBFS)

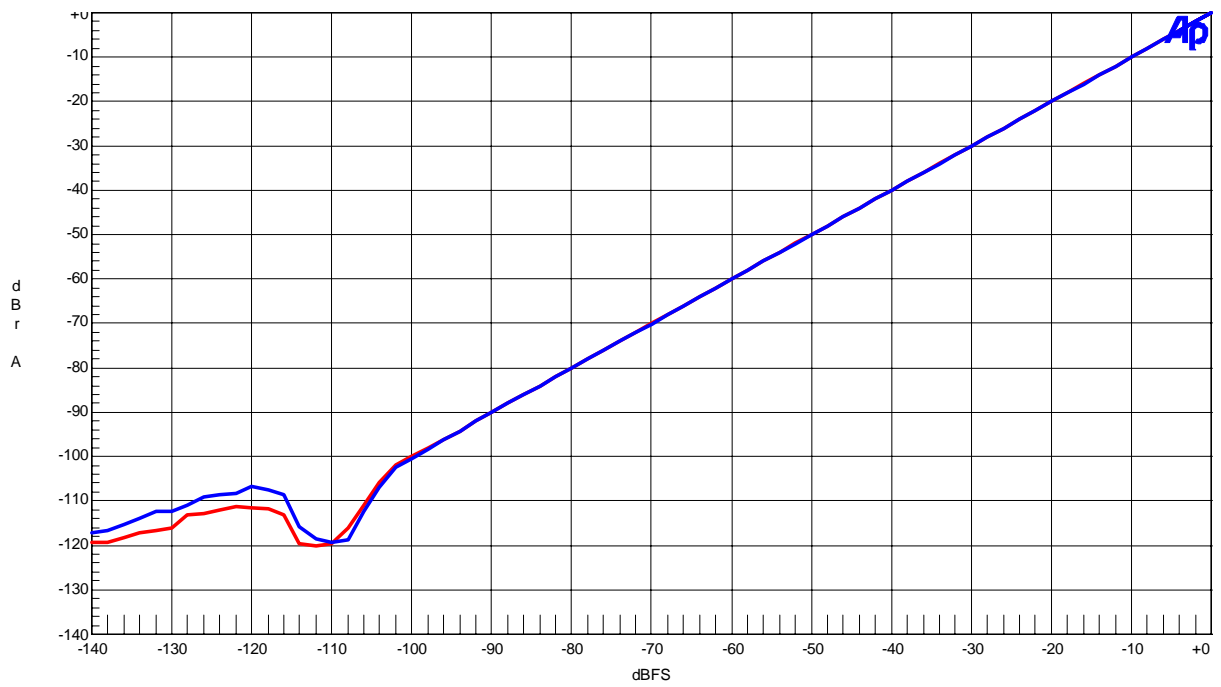

Figure 24. Linearity (Input Frequency=1kHz)

(DAC fs=96kHz)

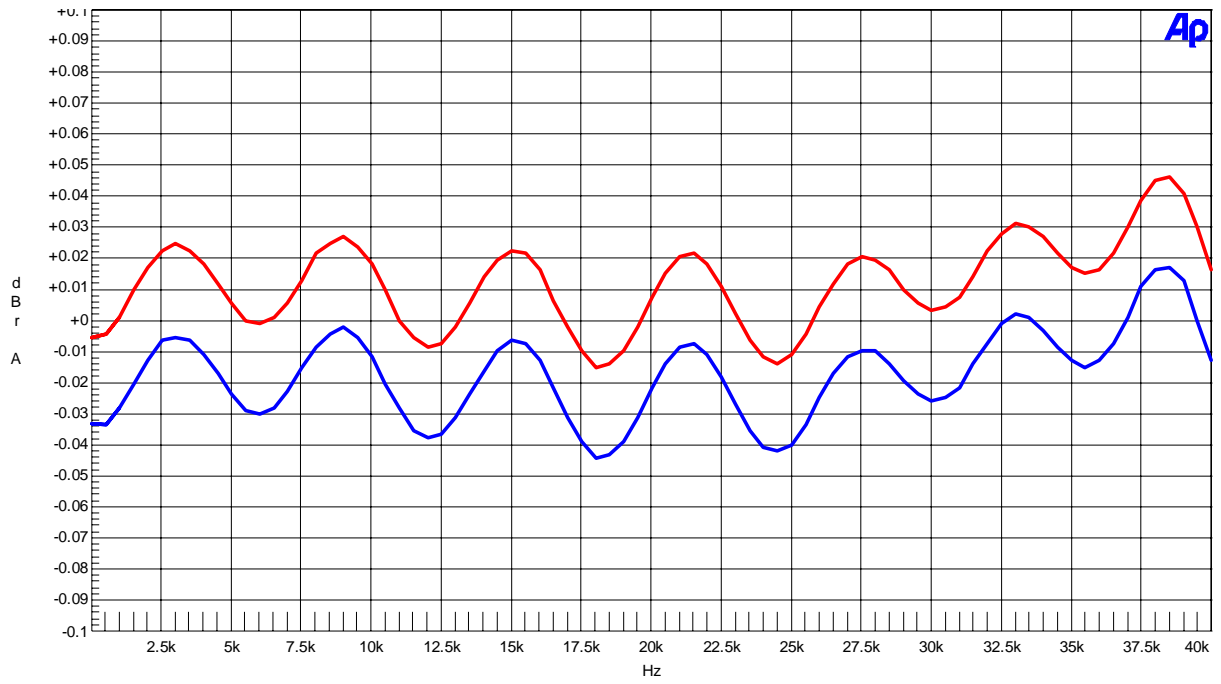

Figure 25. Frequency Response AOUTL Pin / AOUTR Pin (Input Level=0dBFS)

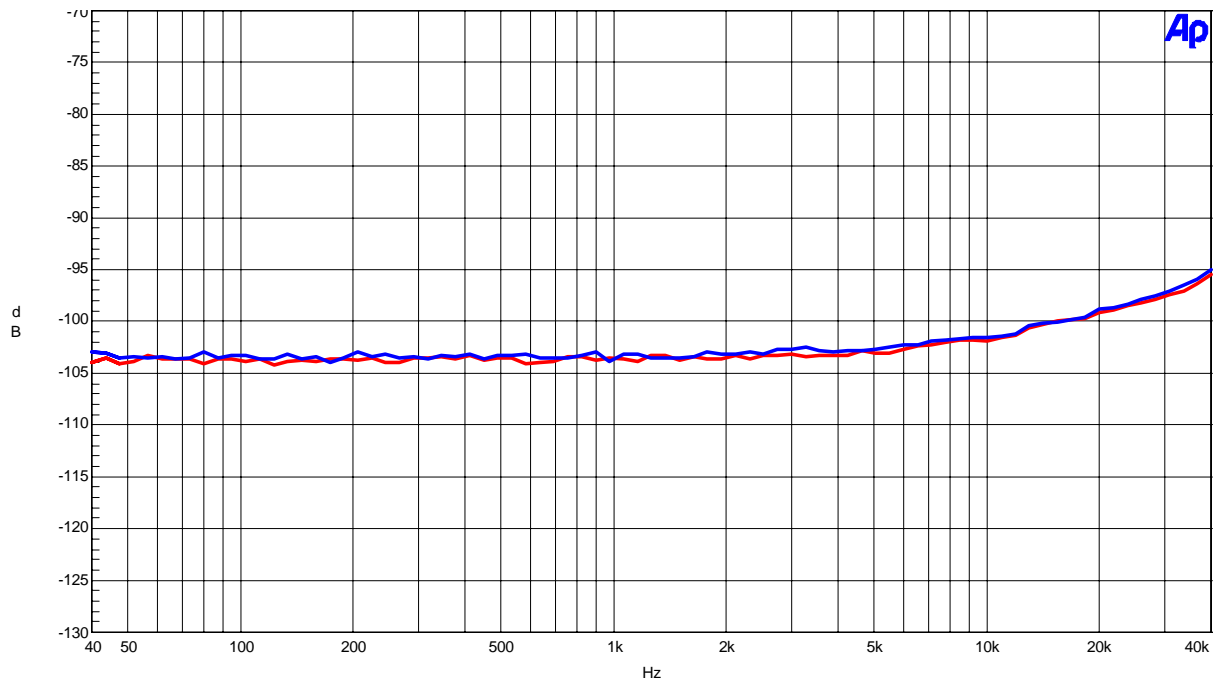

Figure 26. Cross-talk (Input Level=0dBFS)

(DAC fs=192kHz)

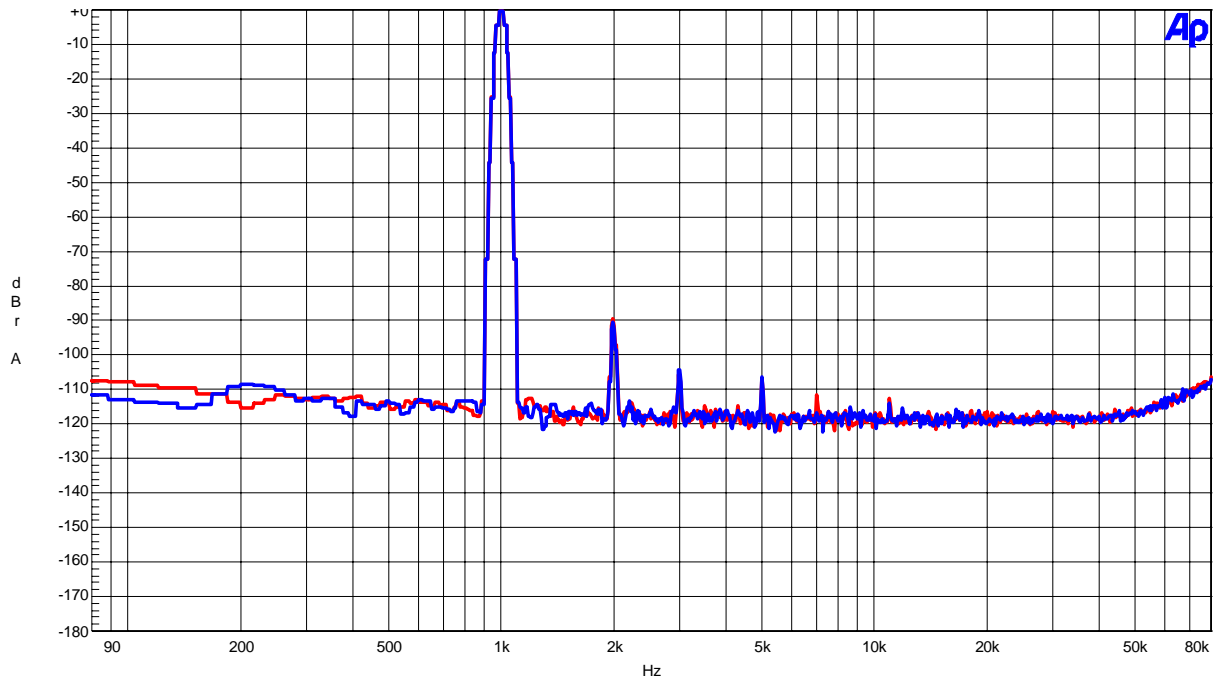

Figure 27. FFT(Input Frequency=1kHz, Input Level=0dBFS)

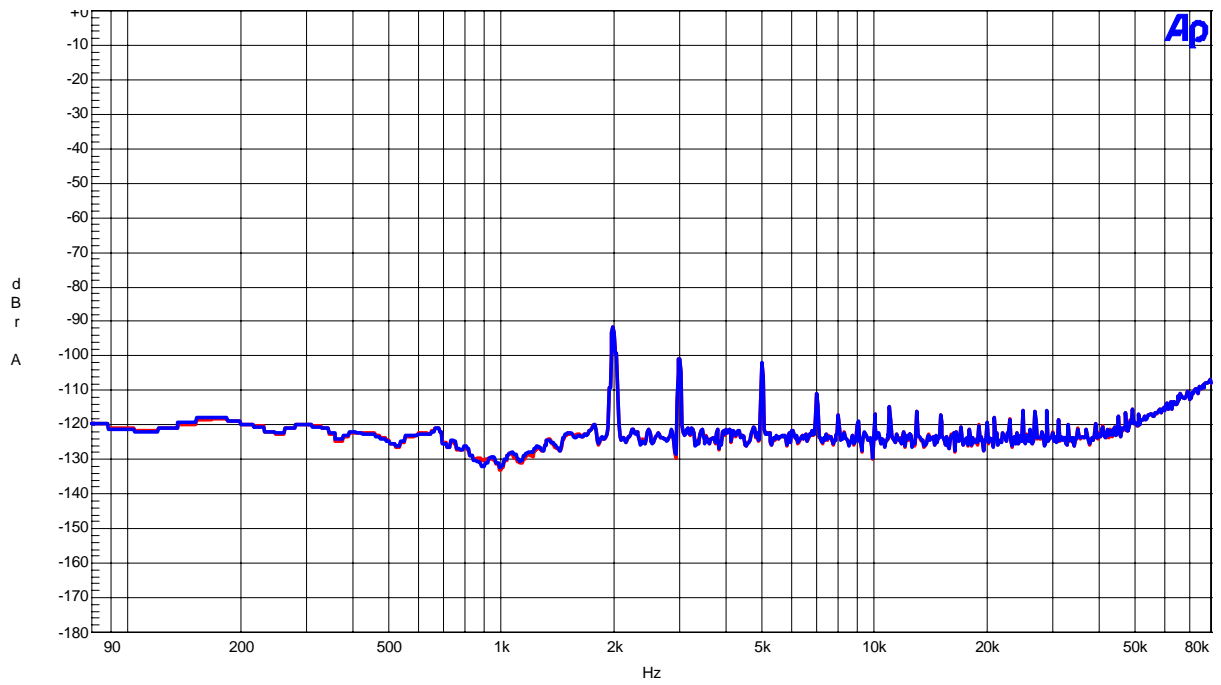

Figure 28. FFT(Input Frequency=1kHz, Input Level=0dBFS,Notch-on)

(DAC fs=192kHz)

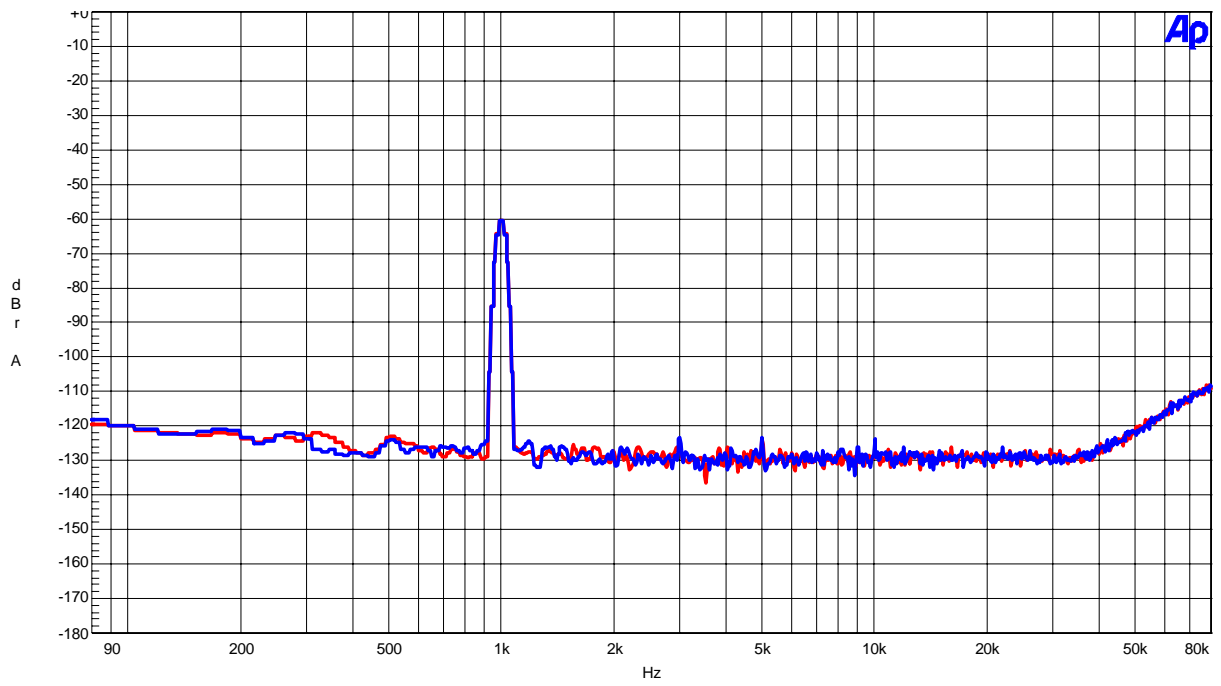

Figure 29. FFT(Input Frequency=1kHz, Input Level=-60dBFS)

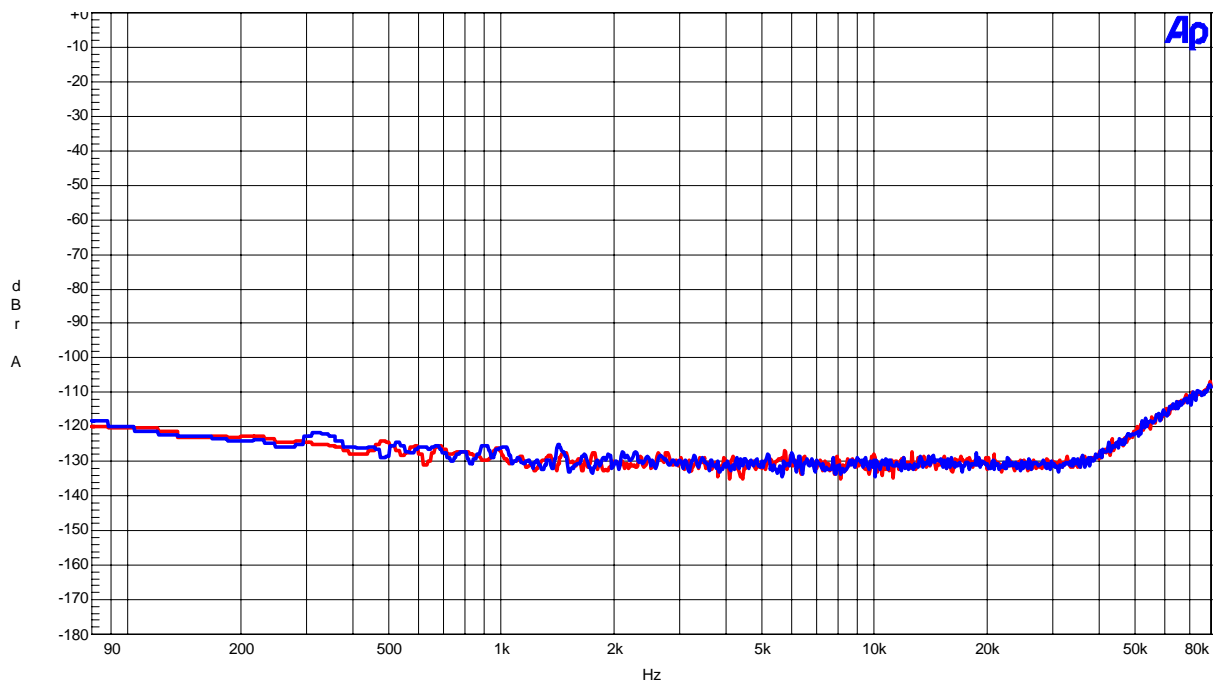

Figure 30. FFT(noise floor)

(DAC fs=192kHz)

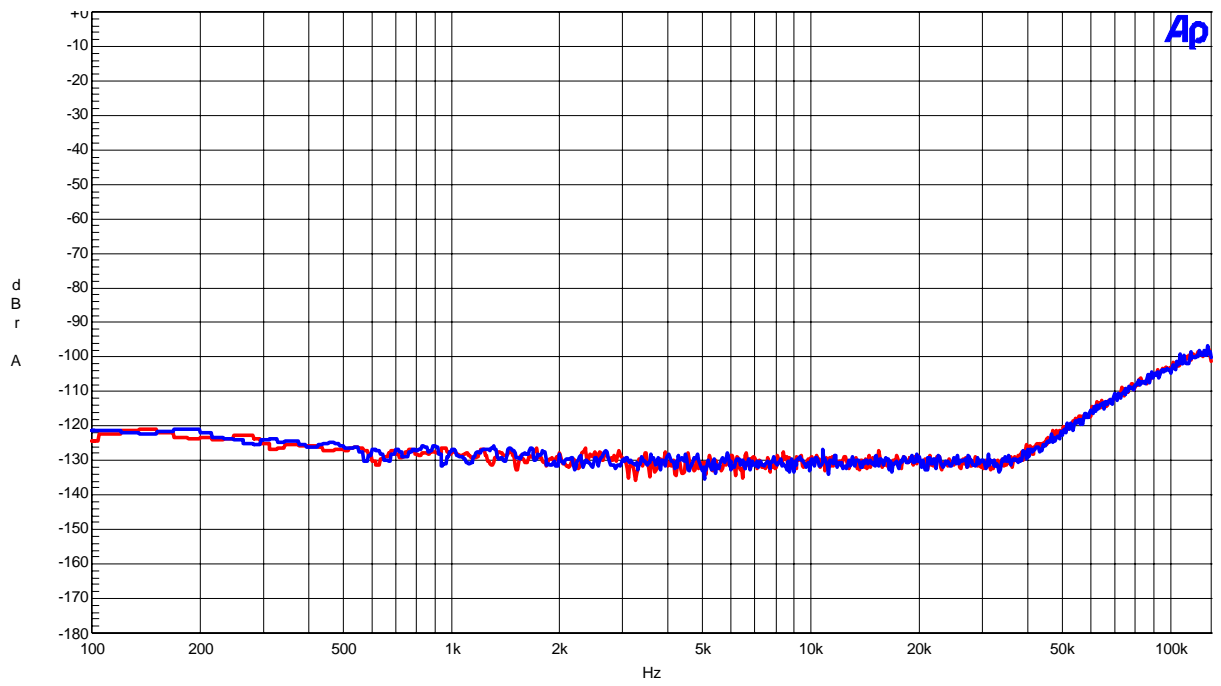

Figure 31. FFT(out-of-band noise)

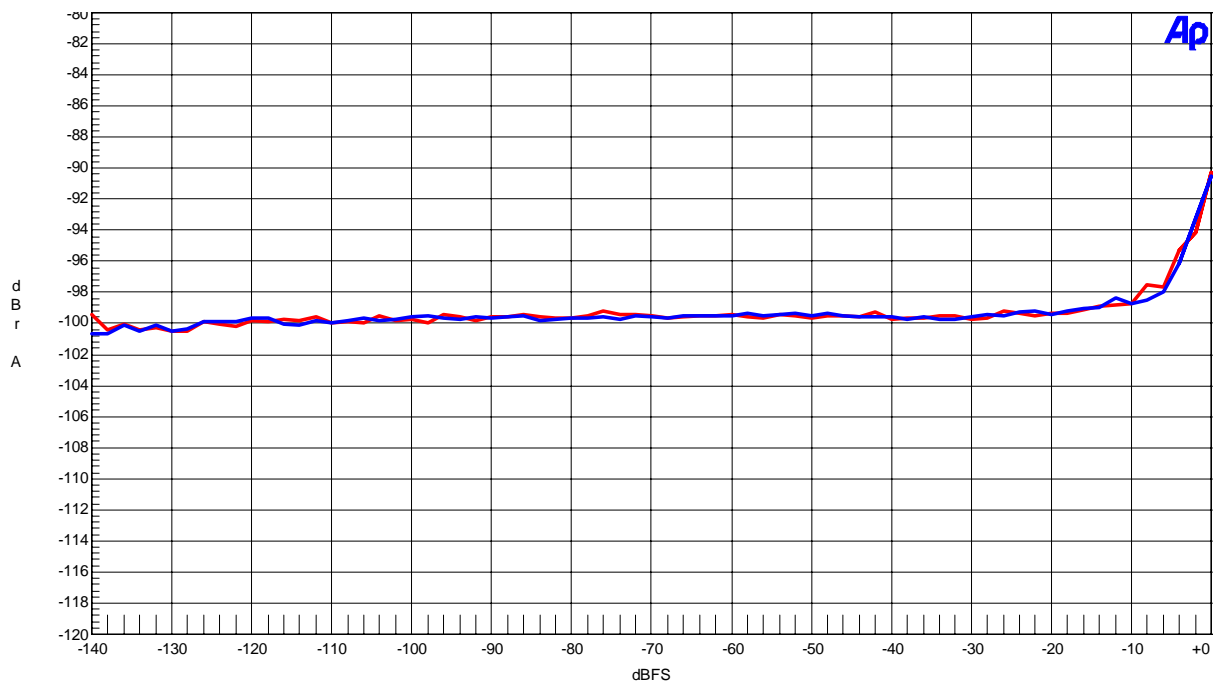

Figure 32. THD+N vs Input Level (Input Frequency=1kHz)

(DAC fs=192kHz)

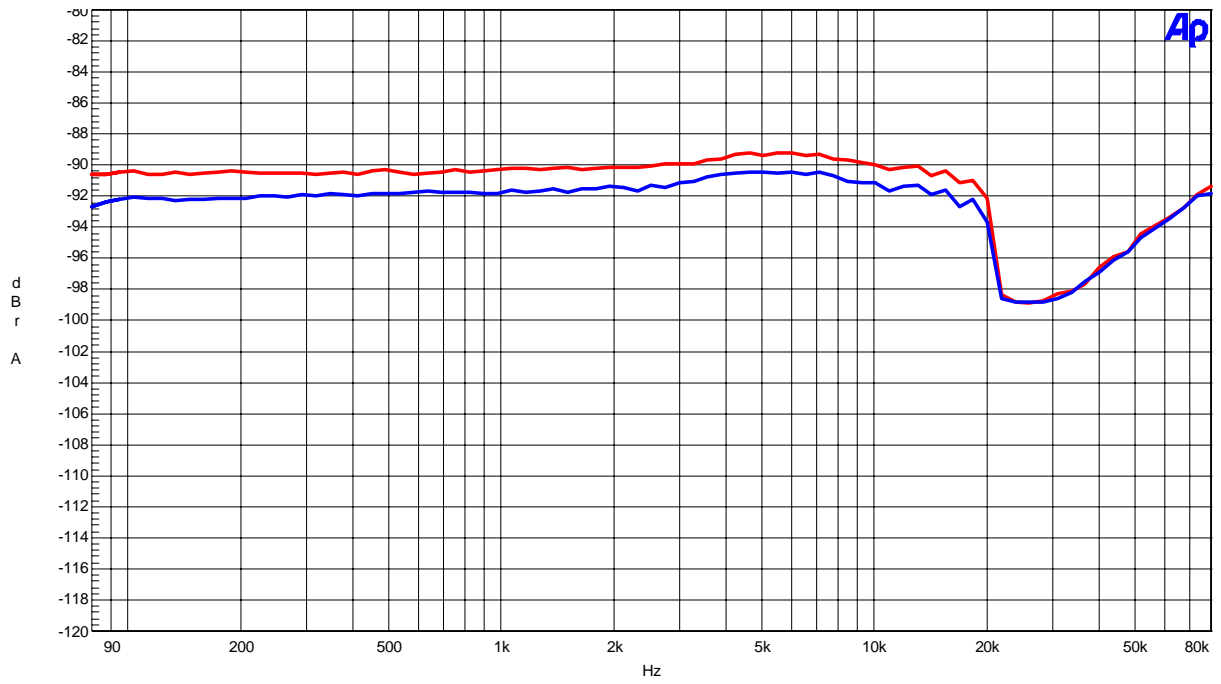

Figure 33. THD+N vs Input Frequency (Input Level=0dBFS)

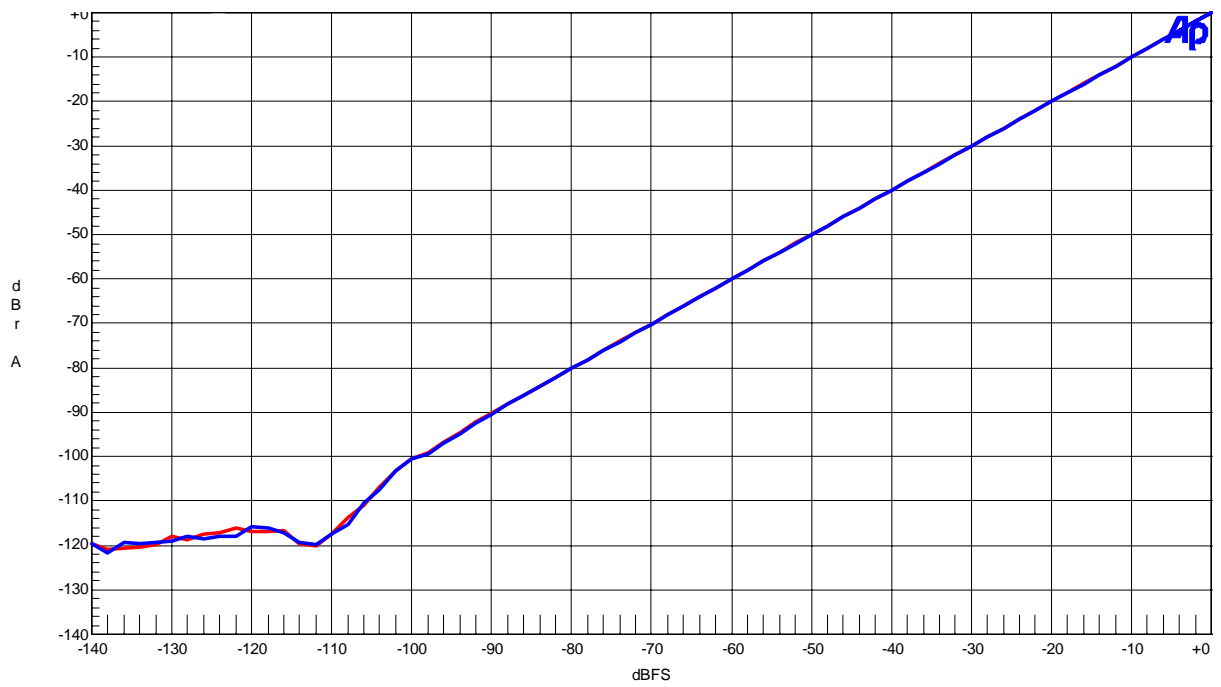

Figure 34. Linearity (Input Frequency=1kHz)

(DAC fs=192kHz)

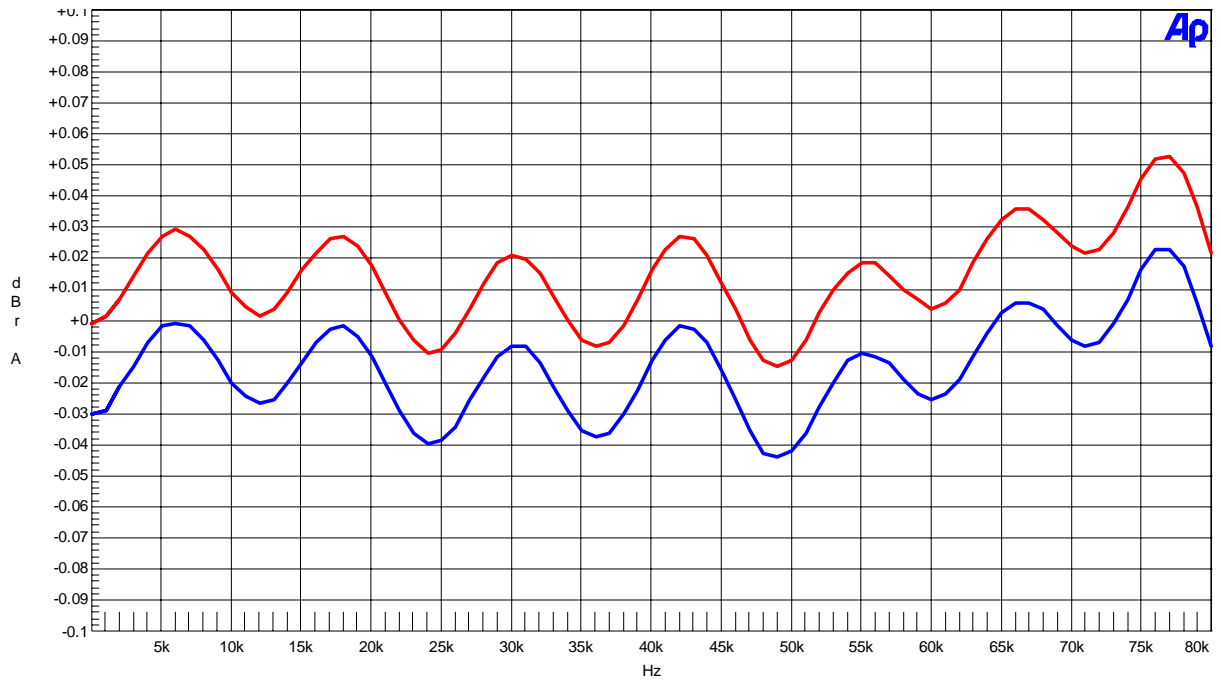

Figure 35. Frequency Response AOUTL Pin / AOUTR Pin (Input Level=0dBFS)

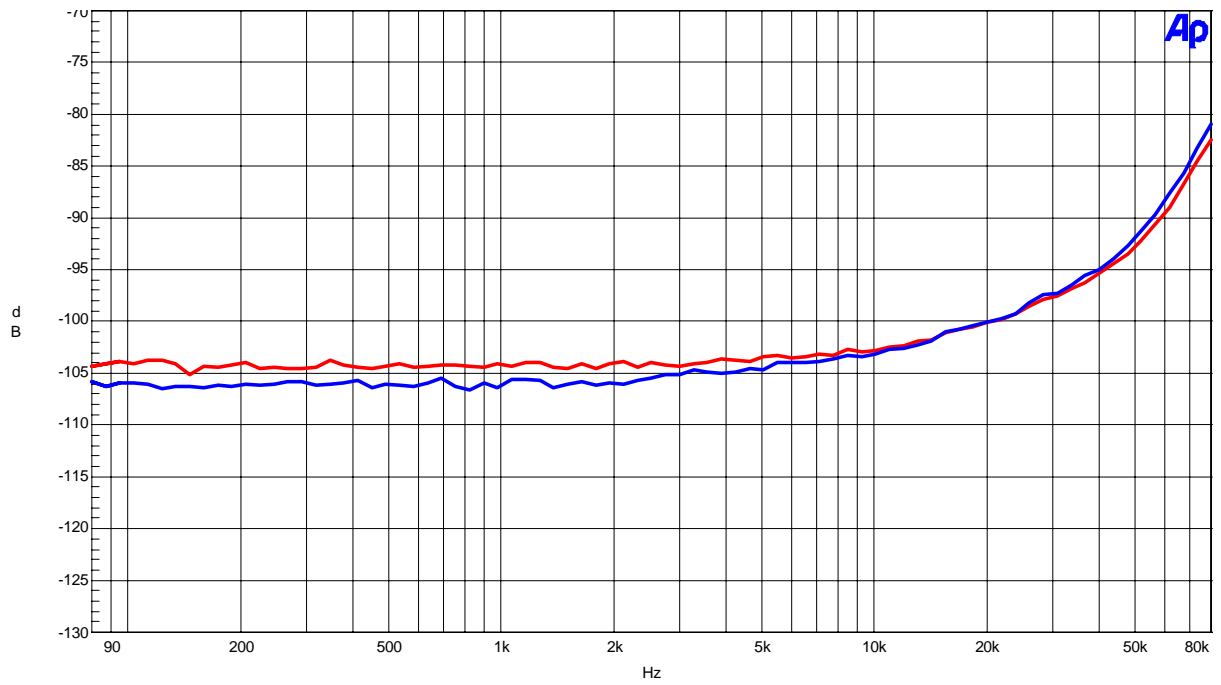

Figure 36. Cross-talk (Input Level=0dBFS)

Revision History

Date (YY/MM/DD)	Manual Revision	Board Revision	Reason	Contents
05/12/05	KM079900	0	First Edition	

IMPORTANT NOTICE

- These products and their specifications are subject to change without notice. Before considering any use or application, consult the Asahi Kasei Microsystems Co., Ltd. (AKM) sales office or authorized distributor concerning their current status.
- AKM assumes no liability for infringement of any patent, intellectual property, or other right in the application or use of any information contained herein.
- Any export of these products, or devices or systems containing them, may require an export license or other official approval under the law and regulations of the country of export pertaining to customs and tariffs, currency exchange, or strategic materials.
- AKM products are neither intended nor authorized for use as critical components in any safety, life support, or other hazard related device or system, and AKM assumes no responsibility relating to any such use, except with the express written consent of the Representative Director of AKM. As used here:
 - (a) A hazard related device or system is one designed or intended for life support or maintenance of safety or for applications in medicine, aerospace, nuclear energy, or other fields, in which its failure to function or perform may reasonably be expected to result in loss of life or in significant injury or damage to person or property.
 - (b) A critical component is one whose failure to function or perform may reasonably be expected to result, whether directly or indirectly, in the loss of the safety or effectiveness of the device or system containing it, and which must therefore meet very high standards of performance and reliability.
- It is the responsibility of the buyer or distributor of an AKM product who distributes, disposes of, or otherwise places the product with a third party to notify that party in advance of the above content and conditions, and the buyer or distributor agrees to assume any and all responsibility and liability for and hold AKM harmless from any and all claims arising from the use of said product in the absence of such notification.

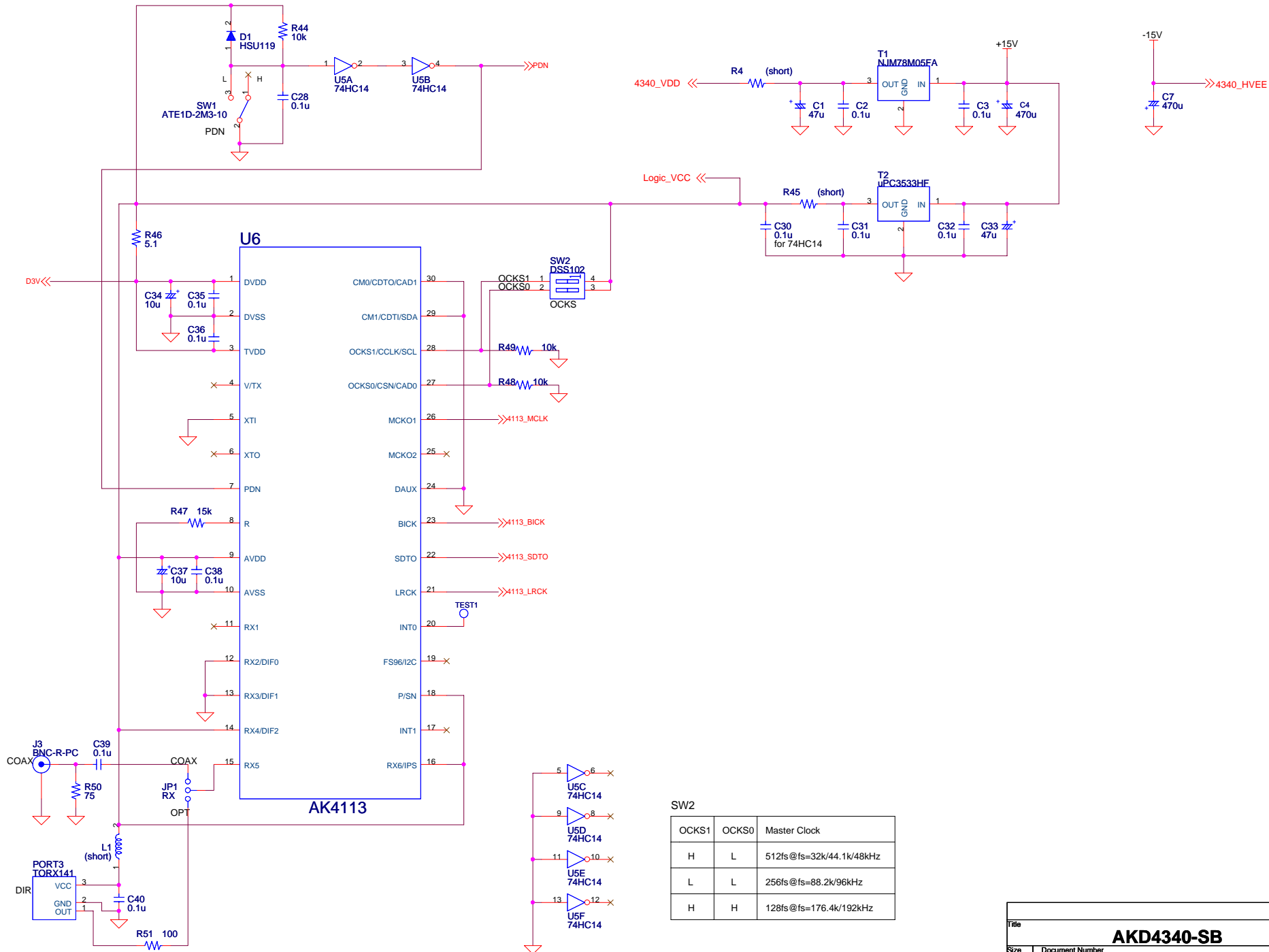

Title			AKD4340-SB		
Size	Document Number				Rev
A3	AK4113				1
Date:	Thursday, October 20, 2005		Sheet	1	of 2

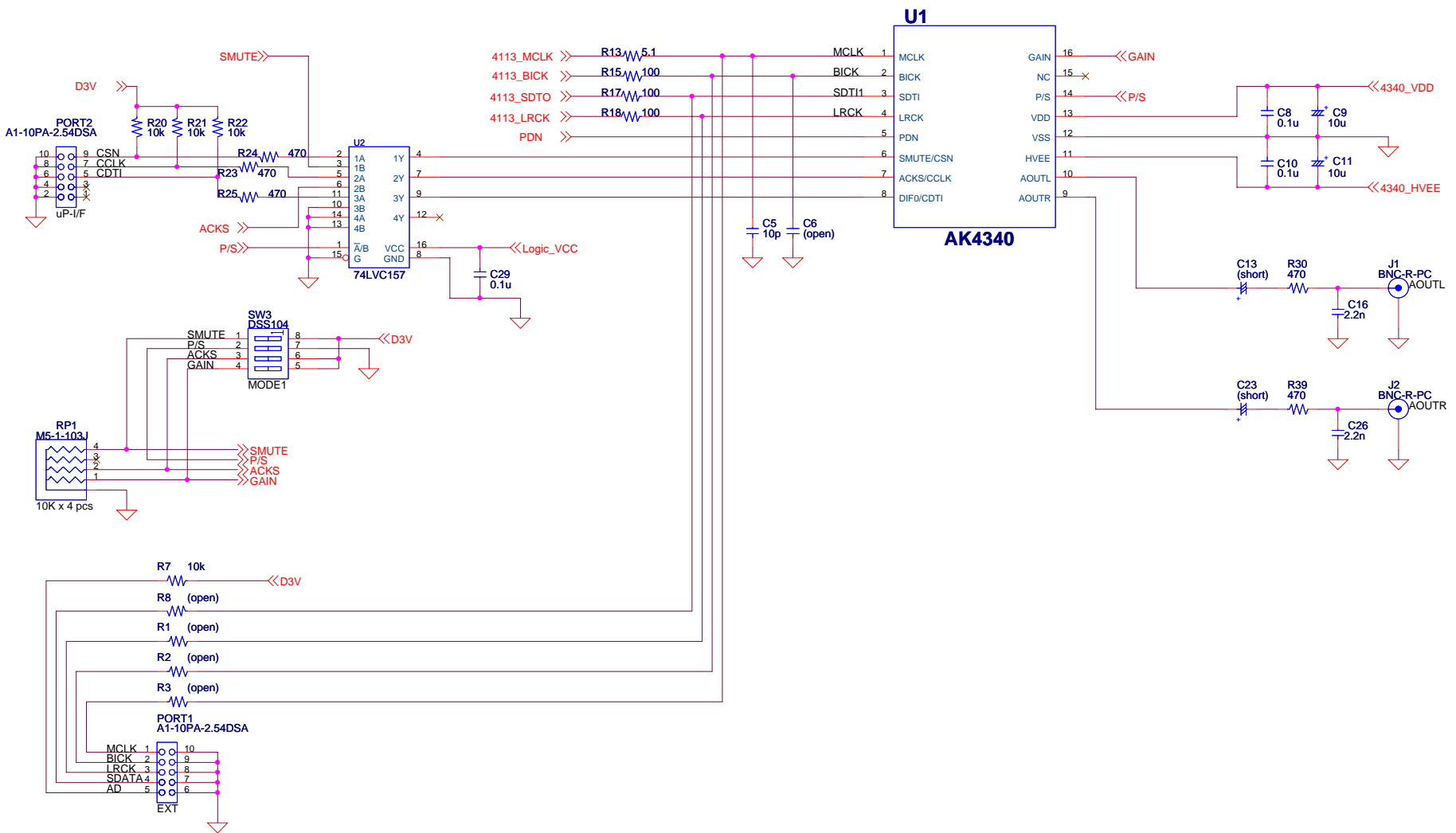

Title			AKD4340-SB		
Size	Document Number	AK4340			Rev
A3					1
Date:	Thursday, October 20, 2005	Sheet	2	of	2