

TOSHIBA Bipolar Linear Integrated Circuit Silicon Monolithic

## TA78DS05BP, TA78DS06BP, TA78DS08BP, TA78DS09BP, TA78DS10BP, TA78DS12BP, TA78DS15BP, TA78DS05CP

5 V, 6 V, 8 V, 9 V, 10 V, 12 V, 15 V

Low Dropout Voltage Regulator

The TA78DS××BP series consists fixed-positive-output voltage regulator ICs capable of sourcing current up to 30 mA. Due to the features of low dropout voltage and low standby current, these devices are useful for battery-powered equipment. This series includes built-in current limiting, thermal shutdown, over voltage protection, input fault protection and excessive transient protection circuits.

### Features

- Low standby current of 600  $\mu$ A typical.
- Maximum output current of 30 mA.
- Low dropout voltage of less than 0.3 V.
- Multi-protection:  
Reverse connection of power supply, 60V load dump, thermal shut down and current limiting.
- Available in the plastic TO-92 MOD package.

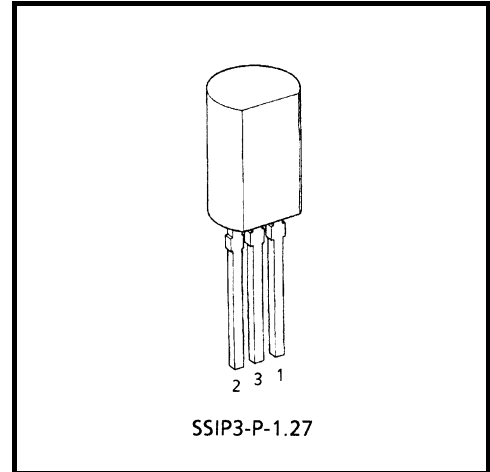

Weight: 0.36 g (Typ.)

### Pin Assignment

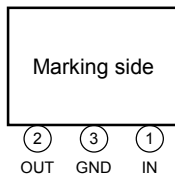

### Marking

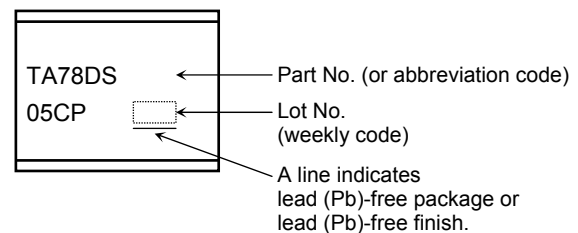
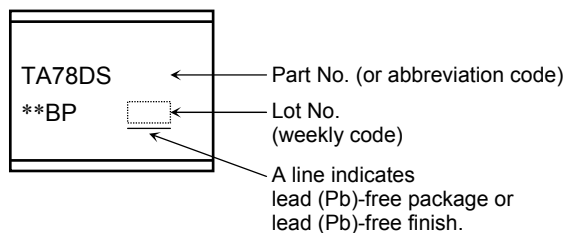

## Block Diagram

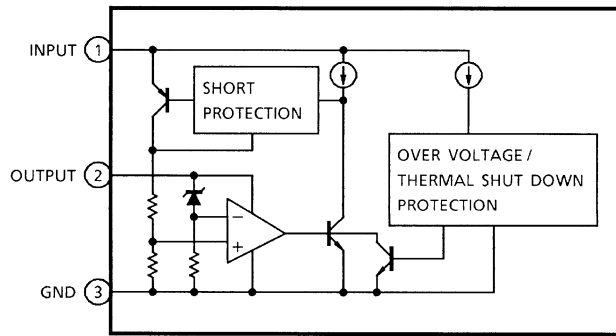

## Absolute Maximum Ratings (Ta = 25°C)

Characteristics	Symbol	Rating	Unit
Operating input voltage	$V_{IN}$	29	V
Input voltage of surge	$V_{IN}$	60	V
Power dissipation (Ta = 25°C)	$P_D$	800	mW
Operating temperature	$T_{opr}$	-40~85	°C
Storage temperature	$T_{stg}$	-55~150	°C
Junction temperature	$T_j$	150	°C
Thermal resistance	$R_{th(j-a)}$	156	°C/W
Soldering temperature time	$T_{sol}$	260 (10 s)	°C

Note: Using continuously under heavy loads (e.g. the application of high temperature/current/voltage and the significant change in temperature, etc.) may cause this product to decrease in the reliability significantly even if the operating conditions (i.e. operating temperature/current/voltage, etc.) are within the absolute maximum ratings and the operating ranges.

Please design the appropriate reliability upon reviewing the Toshiba Semiconductor Reliability Handbook ("Handling Precautions"/Derating Concept and Methods) and individual reliability data (i.e. reliability test report and estimated failure rate, etc).

## TA78DS05BP

### Electrical Characteristics

(Unless otherwise specified,  $V_{IN} = 14\text{ V}$ ,  $I_{OUT} = 5\text{ mA}$ ,  $C_{IN} = 0.1\text{ }\mu\text{F}$ ,  $C_{OUT} = 3.3\text{ }\mu\text{F}$ ,  $T_j = 25^\circ\text{C}$ )

Characteristics	Symbol	Test Circuit	Test Condition	Min	Typ.	Max	Unit
Output voltage	$V_{OUT}$	—	$5.35\text{ V} \leq V_{IN} \leq 26\text{ V}$	4.75	5.0	5.25	V
			$5.35\text{ V} \leq V_{IN} \leq 26\text{ V}$ , $-40^\circ\text{C} \leq T_a \leq 85^\circ\text{C}$	4.5	5.0	5.5	
Line regulation	Reg-line	—	$9.0\text{ V} \leq V_{IN} \leq 16\text{ V}$	—	1	10	mV
			$6.0\text{ V} \leq V_{IN} \leq 26\text{ V}$	—	4	30	
Load regulation	Reg-load	—	$5.0\text{ mA} \leq I_{OUT} \leq 30\text{ mA}$	—	1	50	mV
Quiescent current	$I_B$	—	$I_{OUT} = 0\text{ mA}$	—	0.6	1	mA
			$6\text{ V} \leq V_{IN} \leq 26\text{ V}$ , $I_{OUT} = 5\text{ mA}$	—	0.7	1	
Dropout voltage	$V_D$	—	$I_{OUT} = 5\text{ mA}$	—	0.1	0.2	V
			$I_{OUT} = 10\text{ mA}$	—	0.2	0.3	
Max operating voltage	$V_{IN}$	—	—	29	33	—	V

## TA78DS05CP

### Electrical Characteristics

(Unless otherwise specified,  $V_{IN} = 14\text{ V}$ ,  $I_{OUT} = 5\text{ mA}$ ,  $C_{IN} = 0.1\text{ }\mu\text{F}$ ,  $C_{OUT} = 3.3\text{ }\mu\text{F}$ ,  $T_j = 25^\circ\text{C}$ )

Characteristics	Symbol	Test Circuit	Test Condition	Min	Typ.	Max	Unit
Output voltage	$V_{OUT}$	—	$5.35\text{ V} \leq V_{IN} \leq 26\text{ V}$	4.8	5.0	5.2	V
			$5.35\text{ V} \leq V_{IN} \leq 26\text{ V}$ , $-40^\circ\text{C} \leq T_a \leq 85^\circ\text{C}$	4.75	5.0	5.25	
Line regulation	Reg-line	—	$9.0\text{ V} \leq V_{IN} \leq 16\text{ V}$	—	1	10	mV
			$6.0\text{ V} \leq V_{IN} \leq 26\text{ V}$	—	4	30	
Load regulation	Reg-load	—	$5.0\text{ mA} \leq I_{OUT} \leq 30\text{ mA}$	—	1	50	mV
Quiescent current	$I_B$	—	$I_{OUT} = 0\text{ mA}$	—	0.6	1	mA
			$6\text{ V} \leq V_{IN} \leq 26\text{ V}$ , $I_{OUT} = 5\text{ mA}$	—	0.7	1	
Dropout voltage	$V_D$	—	$I_{OUT} = 5\text{ mA}$	—	0.1	0.2	V
			$I_{OUT} = 10\text{ mA}$	—	0.2	0.3	
Max operating voltage	$V_{IN}$	—	—	29	33	—	V

## TA78DS06BP

### Electrical Characteristics

(Unless otherwise specified,  $V_{IN} = 14\text{ V}$ ,  $I_{OUT} = 5\text{ mA}$ ,  $C_{IN} = 0.1\text{ }\mu\text{F}$ ,  $C_{OUT} = 3.3\text{ }\mu\text{F}$ ,  $T_j = 25^\circ\text{C}$ )

Characteristics	Symbol	Test Circuit	Test Condition	Min	Typ.	Max	Unit
Output voltage	$V_{OUT}$	—	$6.35\text{ V} \leq V_{IN} \leq 26\text{ V}$	5.7	6.0	6.3	V
			$6.35\text{ V} \leq V_{IN} \leq 26\text{ V}$ , $-40^\circ\text{C} \leq T_a \leq 85^\circ\text{C}$	5.4	6.0	6.6	
Line regulation	Reg-line	—	$10\text{ V} \leq V_{IN} \leq 17\text{ V}$	—	1	20	mV
			$7.0\text{ V} \leq V_{IN} \leq 26\text{ V}$	—	4	40	
Load regulation	Reg-load	—	$5.0\text{ mA} \leq I_{OUT} \leq 30\text{ mA}$	—	1	60	mV
Quiescent current	$I_B$	—	$I_{OUT} = 0\text{ mA}$	—	0.6	1.1	mA
			$7\text{ V} \leq V_{IN} \leq 26\text{ V}$ , $I_{OUT} = 5\text{ mA}$	—	0.7	1.1	
Dropout voltage	$V_D$	—	$I_{OUT} = 5\text{ mA}$	—	0.1	0.2	V
			$I_{OUT} = 10\text{ mA}$	—	0.2	0.3	
Max operating voltage	$V_{IN}$	—	—	29	33	—	V

## TA78DS08BP

### Electrical Characteristics

(Unless otherwise specified,  $V_{IN} = 14\text{ V}$ ,  $I_{OUT} = 5\text{ mA}$ ,  $C_{IN} = 0.1\text{ }\mu\text{F}$ ,  $C_{OUT} = 3.3\text{ }\mu\text{F}$ ,  $T_j = 25^\circ\text{C}$ )

Characteristics	Symbol	Test Circuit	Test Condition	Min	Typ.	Max	Unit
Output voltage	$V_{OUT}$	—	$8.35\text{ V} \leq V_{IN} \leq 26\text{ V}$	7.6	8.0	8.4	V
			$8.35\text{ V} \leq V_{IN} \leq 26\text{ V}$ , $-40^\circ\text{C} \leq T_a \leq 85^\circ\text{C}$	7.2	8.0	8.8	
Line regulation	Reg-line	—	$12\text{ V} \leq V_{IN} \leq 19\text{ V}$	—	2	30	mV
			$9.0\text{ V} \leq V_{IN} \leq 26\text{ V}$	—	5	60	
Load regulation	Reg-load	—	$5.0\text{ mA} \leq I_{OUT} \leq 30\text{ mA}$	—	4	80	mV
Quiescent current	$I_B$	—	$I_{OUT} = 0\text{ mA}$	—	0.7	1.2	mA
			$9\text{ V} \leq V_{IN} \leq 26\text{ V}$ , $I_{OUT} = 5\text{ mA}$	—	0.8	1.2	
Dropout voltage	$V_D$	—	$I_{OUT} = 5\text{ mA}$	—	0.1	0.2	V
			$I_{OUT} = 10\text{ mA}$	—	0.2	0.3	
Max operating voltage	$V_{IN}$	—	—	29	33	—	V

## TA78DS09BP

### Electrical Characteristics

(Unless otherwise specified,  $V_{IN} = 14\text{ V}$ ,  $I_{OUT} = 5\text{ mA}$ ,  $C_{IN} = 0.1\text{ }\mu\text{F}$ ,  $C_{OUT} = 3.3\text{ }\mu\text{F}$ ,  $T_j = 25^\circ\text{C}$ )

Characteristics	Symbol	Test Circuit	Test Condition	Min	Typ.	Max	Unit
Output voltage	$V_{OUT}$	—	$9.35\text{ V} \leq V_{IN} \leq 26\text{ V}$	8.55	9.0	9.45	V
			$9.35\text{ V} \leq V_{IN} \leq 26\text{ V}$ , $-40^\circ\text{C} \leq T_a \leq 85^\circ\text{C}$	8.1	9.0	9.9	
Line regulation	Reg-line	—	$13\text{ V} \leq V_{IN} \leq 20\text{ V}$	—	2	35	mV
			$10\text{ V} \leq V_{IN} \leq 26\text{ V}$	—	5	70	
Load regulation	Reg-load	—	$5.0\text{ mA} \leq I_{OUT} \leq 30\text{ mA}$	—	4	90	mV
Quiescent current	$I_B$	—	$I_{OUT} = 0\text{ mA}$	—	0.7	1.3	mA
			$10\text{ V} \leq V_{IN} \leq 26\text{ V}$ , $I_{OUT} = 5\text{ mA}$	—	0.8	1.3	
Dropout voltage	$V_D$	—	$I_{OUT} = 5\text{ mA}$	—	0.1	0.2	V
			$I_{OUT} = 10\text{ mA}$	—	0.2	0.3	
Max operating voltage	$V_{IN}$	—	—	29	33	—	V

## TA78DS10BP

### Electrical Characteristics

(Unless otherwise specified,  $V_{IN} = 14\text{ V}$ ,  $I_{OUT} = 5\text{ mA}$ ,  $C_{IN} = 0.1\text{ }\mu\text{F}$ ,  $C_{OUT} = 3.3\text{ }\mu\text{F}$ ,  $T_j = 25^\circ\text{C}$ )

Characteristics	Symbol	Test Circuit	Test Condition	Min	Typ.	Max	Unit
Output voltage	$V_{OUT}$	—	$10.35\text{ V} \leq V_{IN} \leq 26\text{ V}$	9.5	10.0	10.5	V
			$10.35\text{ V} \leq V_{IN} \leq 26\text{ V}$ , $-40^\circ\text{C} \leq T_a \leq 85^\circ\text{C}$	9.0	10.0	11.0	
Line regulation	Reg-line	—	$14\text{ V} \leq V_{IN} \leq 21\text{ V}$	—	3	40	mV
			$11\text{ V} \leq V_{IN} \leq 26\text{ V}$	—	7	80	
Load regulation	Reg-load	—	$5.0\text{ mA} \leq I_{OUT} \leq 30\text{ mA}$	—	6	100	mV
Quiescent current	$I_B$	—	$I_{OUT} = 0\text{ mA}$	—	0.7	1.4	mA
			$11\text{ V} \leq V_{IN} \leq 26\text{ V}$ , $I_{OUT} = 5\text{ mA}$	—	0.8	1.4	
Dropout voltage	$V_D$	—	$I_{OUT} = 5\text{ mA}$	—	0.1	0.2	V
			$I_{OUT} = 10\text{ mA}$	—	0.2	0.3	
Max operating voltage	$V_{IN}$	—	—	29	33	—	V

## TA78DS12BP

### Electrical Characteristics

(Unless otherwise specified,  $V_{IN} = 18\text{ V}$ ,  $I_{OUT} = 5\text{ mA}$ ,  $C_{IN} = 0.1\text{ }\mu\text{F}$ ,  $C_{OUT} = 3.3\text{ }\mu\text{F}$ ,  $T_j = 25^\circ\text{C}$ )

Characteristics	Symbol	Test Circuit	Test Condition	Min	Typ.	Max	Unit
Output voltage	$V_{OUT}$	—	$12.35\text{ V} \leq V_{IN} \leq 26\text{ V}$	11.4	12.0	12.6	V
			$12.35\text{ V} \leq V_{IN} \leq 26\text{ V}$ , $-40^\circ\text{C} \leq T_a \leq 85^\circ\text{C}$	10.8	12.0	13.2	
Line regulation	Reg-line	—	$16\text{ V} \leq V_{IN} \leq 23\text{ V}$	—	4	50	mV
			$13\text{ V} \leq V_{IN} \leq 26\text{ V}$	—	8	100	
Load regulation	Reg-load	—	$5.0\text{ mA} \leq I_{OUT} \leq 30\text{ mA}$	—	2	120	mV
Quiescent current	$I_B$	—	$I_{OUT} = 0\text{ mA}$	—	0.8	1.5	mA
			$13\text{ V} \leq V_{IN} \leq 26\text{ V}$ , $I_{OUT} = 5\text{ mA}$	—	1.0	1.5	
Dropout voltage	$V_D$	—	$I_{OUT} = 5\text{ mA}$	—	0.1	0.2	V
			$I_{OUT} = 10\text{ mA}$	—	0.2	0.3	
Max operating voltage	$V_{IN}$	—	—	29	33	—	V

## TA78DS15BP

### Electrical Characteristics

(Unless otherwise specified,  $V_{IN} = 20\text{ V}$ ,  $I_{OUT} = 5\text{ mA}$ ,  $C_{IN} = 0.1\text{ }\mu\text{F}$ ,  $C_{OUT} = 3.3\text{ }\mu\text{F}$ ,  $T_j = 25^\circ\text{C}$ )

Characteristics	Symbol	Test Circuit	Test Condition	Min	Typ.	Max	Unit
Output voltage	$V_{OUT}$	—	$15.35\text{ V} \leq V_{IN} \leq 26\text{ V}$	14.25	15.0	15.75	V
			$15.35\text{ V} \leq V_{IN} \leq 26\text{ V}$ , $-40^\circ\text{C} \leq T_a \leq 85^\circ\text{C}$	13.5	15.0	16.5	
Line regulation	Reg-line	—	$19\text{ V} \leq V_{IN} \leq 26\text{ V}$	—	5	60	mV
			$16\text{ V} \leq V_{IN} \leq 26\text{ V}$	—	8	130	
Load regulation	Reg-load	—	$5.0\text{ mA} \leq I_{OUT} \leq 30\text{ mA}$	—	1	150	mV
Quiescent current	$I_B$	—	$I_{OUT} = 0\text{ mA}$	—	1.0	1.6	mA
			$16\text{ V} \leq V_{IN} \leq 26\text{ V}$ , $I_{OUT} = 5\text{ mA}$	—	1.2	1.6	
Dropout voltage	$V_D$	—	$I_{OUT} = 5\text{ mA}$	—	0.1	0.2	V
			$I_{OUT} = 10\text{ mA}$	—	0.2	0.3	
Max operating voltage	$V_{IN}$	—	—	29	33	—	V

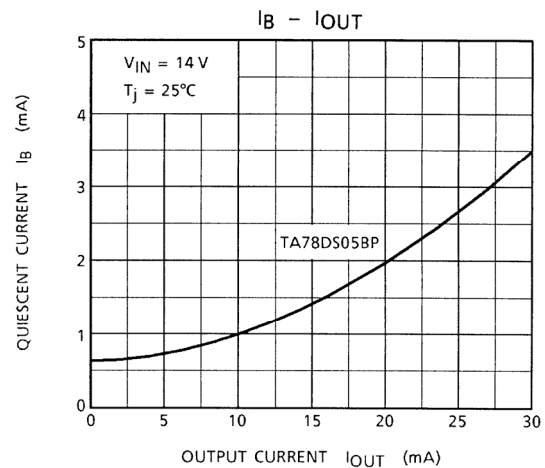
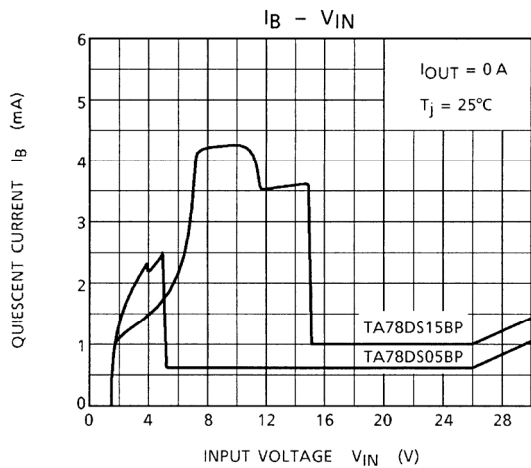
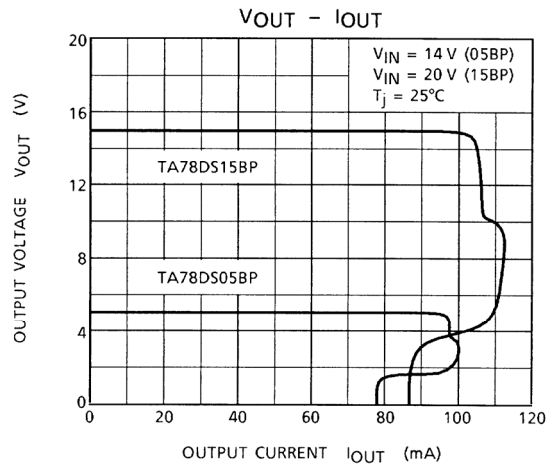
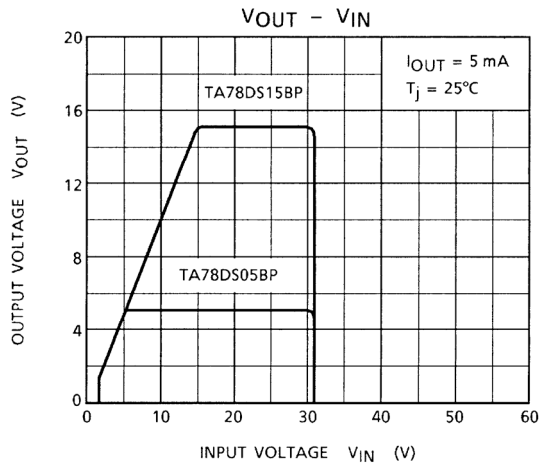
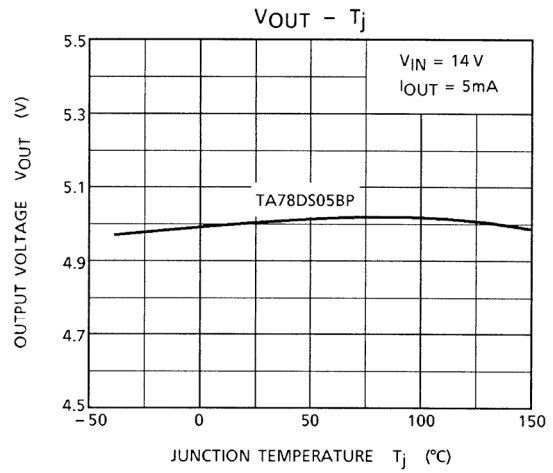
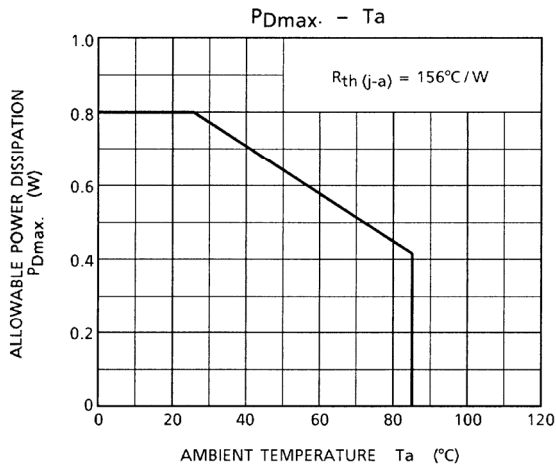

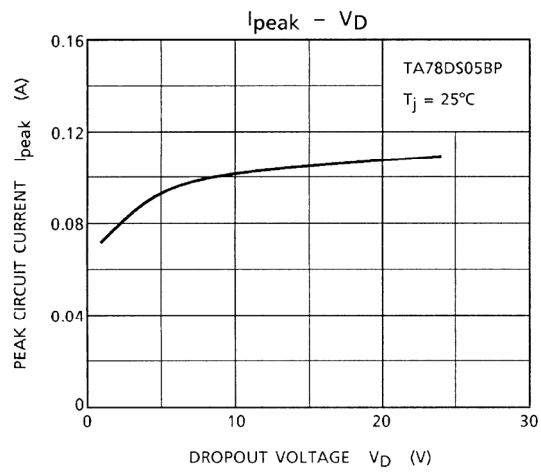
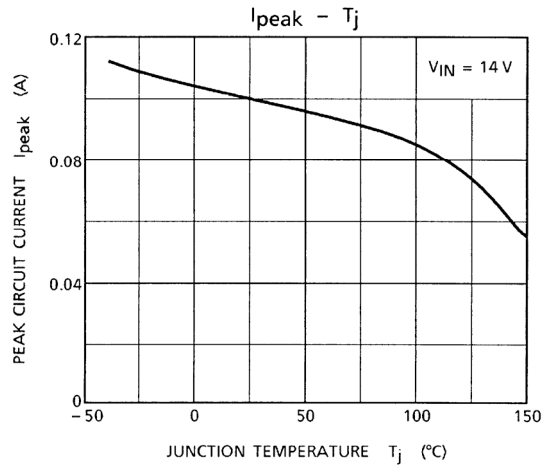
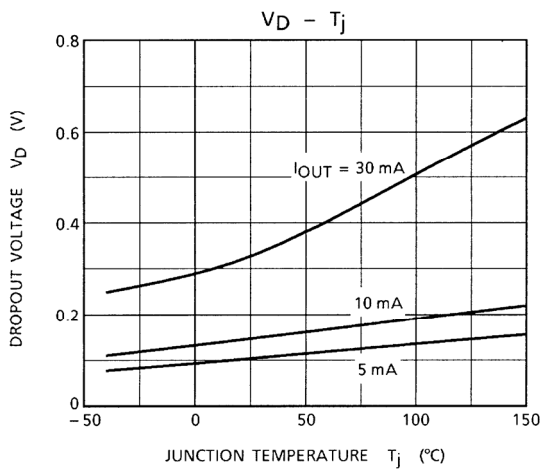
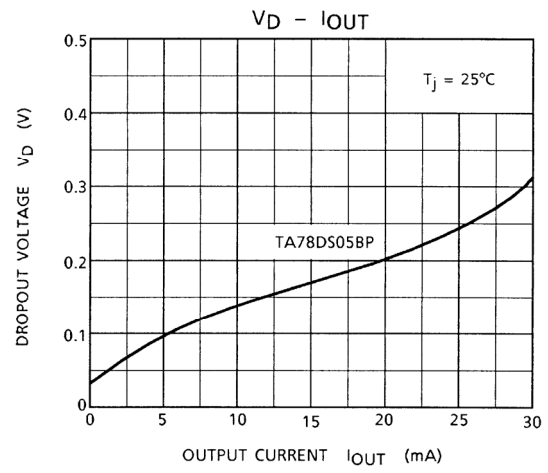
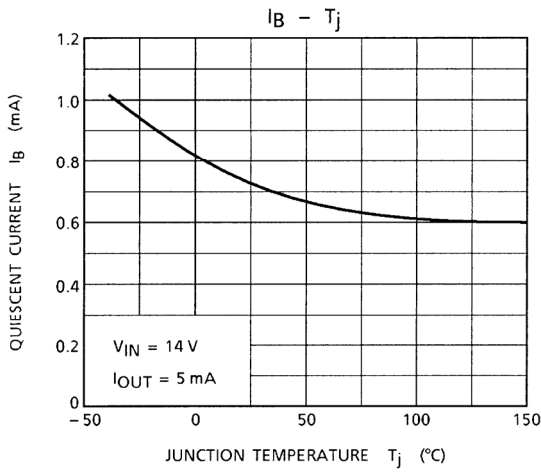

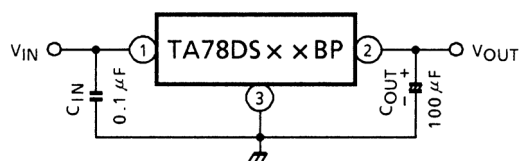

**Application Circuit**

The capacitors  $C_{IN}/C_{OUT}$  must be guaranteed to operate within the temperature range in which the regulator operates correctly.

The equivalent series resistance (ESR) of  $C_{OUT}$  must be less than  $1 \Omega$  inside the operating temperature range.



**RESTRICTIONS ON PRODUCT USE**

20070701-EN

- The information contained herein is subject to change without notice.
- TOSHIBA is continually working to improve the quality and reliability of its products. Nevertheless, semiconductor devices in general can malfunction or fail due to their inherent electrical sensitivity and vulnerability to physical stress. It is the responsibility of the buyer, when utilizing TOSHIBA products, to comply with the standards of safety in making a safe design for the entire system, and to avoid situations in which a malfunction or failure of such TOSHIBA products could cause loss of human life, bodily injury or damage to property.  
In developing your designs, please ensure that TOSHIBA products are used within specified operating ranges as set forth in the most recent TOSHIBA products specifications. Also, please keep in mind the precautions and conditions set forth in the "Handling Guide for Semiconductor Devices," or "TOSHIBA Semiconductor Reliability Handbook" etc.
- The TOSHIBA products listed in this document are intended for usage in general electronics applications (computer, personal equipment, office equipment, measuring equipment, industrial robotics, domestic appliances, etc.). These TOSHIBA products are neither intended nor warranted for usage in equipment that requires extraordinarily high quality and/or reliability or a malfunction or failure of which may cause loss of human life or bodily injury ("Unintended Usage"). Unintended Usage include atomic energy control instruments, airplane or spaceship instruments, transportation instruments, traffic signal instruments, combustion control instruments, medical instruments, all types of safety devices, etc.. Unintended Usage of TOSHIBA products listed in this document shall be made at the customer's own risk.
- The products described in this document shall not be used or embedded to any downstream products of which manufacture, use and/or sale are prohibited under any applicable laws and regulations.
- The information contained herein is presented only as a guide for the applications of our products. No responsibility is assumed by TOSHIBA for any infringements of patents or other rights of the third parties which may result from its use. No license is granted by implication or otherwise under any patents or other rights of TOSHIBA or the third parties.
- Please contact your sales representative for product-by-product details in this document regarding RoHS compatibility. Please use these products in this document in compliance with all applicable laws and regulations that regulate the inclusion or use of controlled substances. Toshiba assumes no liability for damage or losses occurring as a result of noncompliance with applicable laws and regulations.