

# IRFPF40PbF

## HEXFET® Power MOSFET

- Dynamic dv/dt Rating
- Repetitive Avalanche Rated
- Isolated Central Mounting Hole
- Fast Switching
- Ease of Paralleling
- Simple Drive Requirements
- Lead-Free

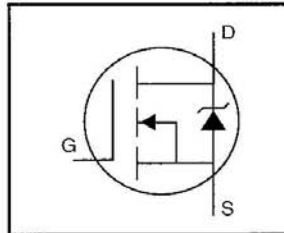

$$V_{DSS} = 900V$$

$$R_{DS(on)} = 2.5\Omega$$

$$I_D = 4.7A$$

### Description

Third Generation HEXFETs from International Rectifier provide the designer with the best combination of fast switching, ruggedized device design, low on-resistance and cost-effectiveness.

The TO-247 package is preferred for commercial-industrial applications where higher power levels preclude the use of TO-220 devices. The TO-247 is similar but superior to the earlier TO-218 package because of its isolated mounting hole. It also provides greater creepage distance between pins to meet the requirements of most safety specifications.

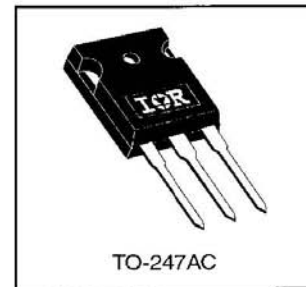

### Absolute Maximum Ratings

Parameter	Max.	Units
$I_D @ T_C = 25^\circ C$	Continuous Drain Current, $V_{GS} @ 10 V$	4.7
$I_D @ T_C = 100^\circ C$	Continuous Drain Current, $V_{GS} @ 10 V$	2.9
$I_{DM}$	Pulsed Drain Current ①	19
$P_D @ T_C = 25^\circ C$	Power Dissipation	150
	Linear Derating Factor	1.2
$V_{GS}$	Gate-to-Source Voltage	$\pm 20$
$E_{AS}$	Single Pulse Avalanche Energy ②	500
$I_{AR}$	Avalanche Current ①	4.7
$E_{AR}$	Repetitive Avalanche Energy ①	15
dv/dt	Peak Diode Recovery dv/dt ③	1.5
$T_J$ $T_{STG}$	Operating Junction and Storage Temperature Range	-55 to +150
	Soldering Temperature, for 10 seconds	300 (1.6mm from case)
	Mounting Torque, 6-32 or M3 screw	10 lbf•in (1.1 N•m)

### Thermal Resistance

Parameter	Min.	Typ.	Max.	Units
$R_{\theta JC}$	—	—	0.83	°C/W
$R_{\theta CS}$	—	0.24	—	
$R_{\theta JA}$	—	—	40	

# IRFPF40PbF

International  
IR Rectifier

## Electrical Characteristics @ $T_J = 25^\circ\text{C}$ (unless otherwise specified)

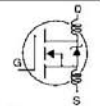
	Parameter	Min.	Typ.	Max.	Units	Test Conditions
$V_{(BR)DSS}$	Drain-to-Source Breakdown Voltage	900	—	—	V	$V_{GS}=0V, I_D=250\mu A$
$\Delta V_{(BR)DSS}/\Delta T_J$	Breakdown Voltage Temp. Coefficient	—	1.0	—	V/ $^\circ\text{C}$	Reference to $25^\circ\text{C}, I_D=1\text{mA}$
$R_{DS(on)}$	Static Drain-to-Source On-Resistance	—	—	2.5	$\Omega$	$V_{GS}=10V, I_D=2.8A$ ④
$V_{GS(th)}$	Gate Threshold Voltage	2.0	—	4.0	V	$V_{DS}=V_{GS}, I_D=250\mu A$
$g_{fs}$	Forward Transconductance	2.5	—	—	S	$V_{DS}=50V, I_D=2.8A$ ④
$I_{DSS}$	Drain-to-Source Leakage Current	—	—	100	$\mu A$	$V_{DS}=900V, V_{GS}=0V$
		—	—	500		$V_{DS}=720V, V_{GS}=0V, T_J=125^\circ\text{C}$
$I_{GSS}$	Gate-to-Source Forward Leakage	—	—	100	nA	$V_{GS}=20V$
	Gate-to-Source Reverse Leakage	—	—	-100		$V_{GS}=-20V$
$Q_g$	Total Gate Charge	—	—	120	nC	$I_D=4.7A$
$Q_{gs}$	Gate-to-Source Charge	—	—	16		$V_{DS}=360V$
$Q_{gd}$	Gate-to-Drain ("Miller") Charge	—	—	67		$V_{GS}=10V$ See Fig. 6 and 13 ④
$t_{d(on)}$	Turn-On Delay Time	—	15	—	ns	$V_{DD}=450V$
$t_r$	Rise Time	—	36	—		$I_D=4.7A$
$t_{d(off)}$	Turn-Off Delay Time	—	110	—		$R_G=9.1\Omega$
$t_f$	Fall Time	—	32	—		$R_D=95\Omega$ See Figure 10 ④
$L_D$	Internal Drain Inductance	—	5.0	—	nH	Between lead, 6 mm (0.25in.) from package and center of die contact 
$L_S$	Internal Source Inductance	—	13	—		
$C_{iss}$	Input Capacitance	—	1600	—	pF	$V_{GS}=0V$
$C_{oss}$	Output Capacitance	—	180	—		$V_{DS}=25V$
$C_{rss}$	Reverse Transfer Capacitance	—	63	—		$f=1.0\text{MHz}$ See Figure 5

## Source-Drain Ratings and Characteristics

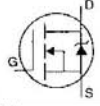
	Parameter	Min.	Typ.	Max.	Units	Test Conditions
$I_S$	Continuous Source Current (Body Diode)	—	—	4.7	A	MOSFET symbol showing the integral reverse p-n junction diode. 
$I_{SM}$	Pulsed Source Current (Body Diode) ①	—	—	19		
$V_{SD}$	Diode Forward Voltage	—	—	1.8	V	$T_J=25^\circ\text{C}, I_S=4.7A, V_{GS}=0V$ ④
$t_{rr}$	Reverse Recovery Time	—	510	770	ns	$T_J=25^\circ\text{C}, I_F=4.7A$
$Q_{rr}$	Reverse Recovery Charge	—	2.2	3.3	$\mu C$	$di/dt=100A/\mu s$ ④
$t_{on}$	Forward Turn-On Time	Intrinsic turn-on time is negligible (turn-on is dominated by $L_S+L_D$ )				

### Notes:

① Repetitive rating; pulse width limited by max. junction temperature (See Figure 11)

②  $V_{DD}=50V$ , starting  $T_J=25^\circ\text{C}$ ,  $L=42\text{mH}$ ,  $R_G=25\Omega$ ,  $I_{AS}=4.7A$  (See Figure 12)

③  $I_{SD}\leq 4.7A$ ,  $di/dt\leq 110A/\mu s$ ,  $V_{DD}\leq 600$ ,  $T_J\leq 150^\circ\text{C}$

④ Pulse width  $\leq 300\mu s$ ; duty cycle  $\leq 2\%$ .

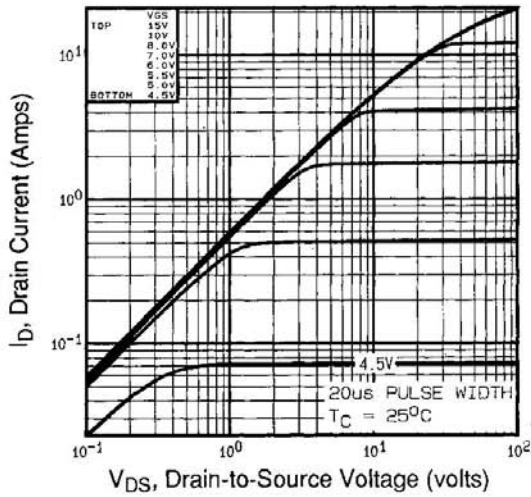

**Fig 1.** Typical Output Characteristics,  
 $T_C=25^\circ\text{C}$

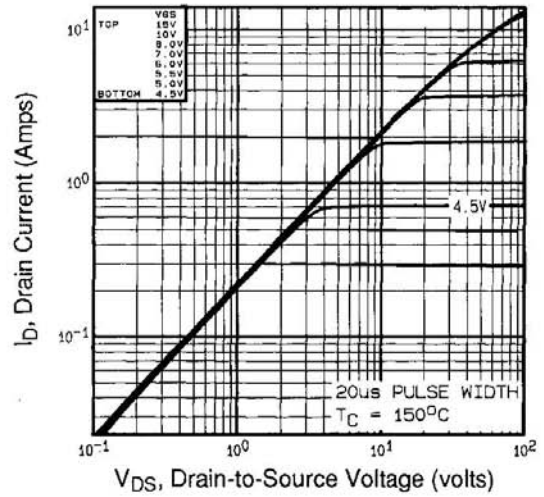

**Fig 2.** Typical Output Characteristics,  
 $T_C=150^\circ\text{C}$

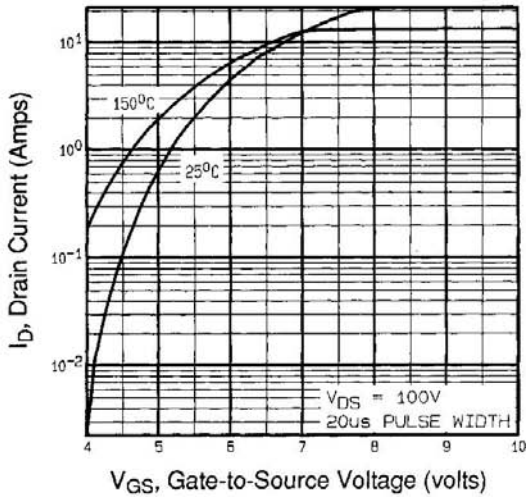

**Fig 3.** Typical Transfer Characteristics

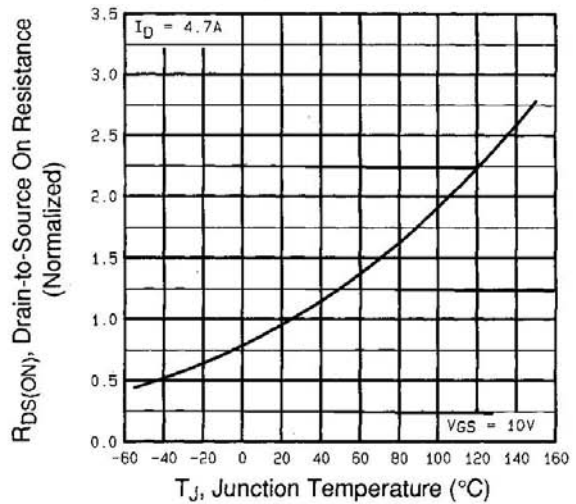

**Fig 4.** Normalized On-Resistance  
Vs. Temperature

# IRFPF40PbF

International  
**IR** Rectifier

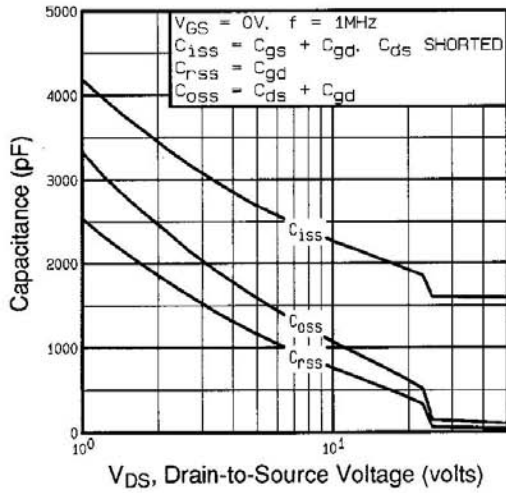

**Fig 5.** Typical Capacitance Vs. Drain-to-Source Voltage

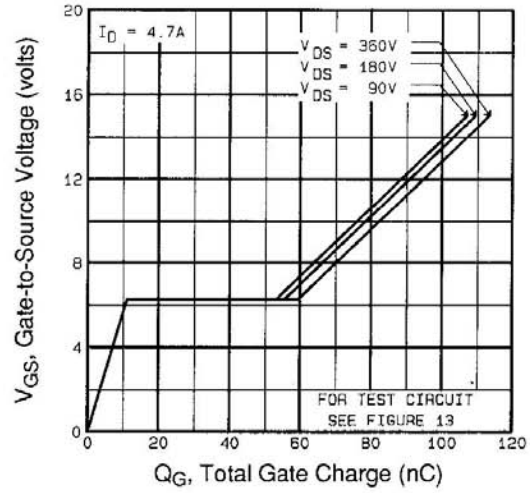

**Fig 6.** Typical Gate Charge Vs. Gate-to-Source Voltage

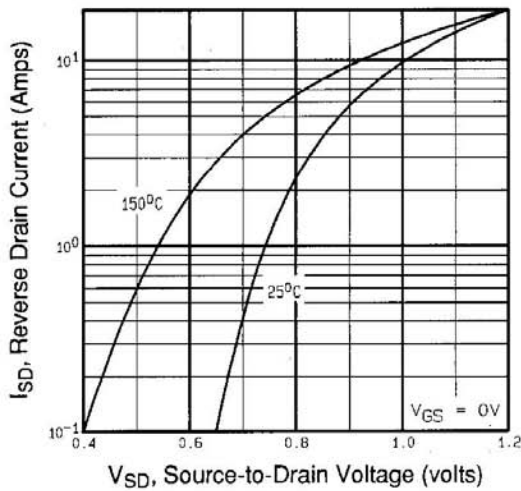

**Fig 7.** Typical Source-Drain Diode Forward Voltage

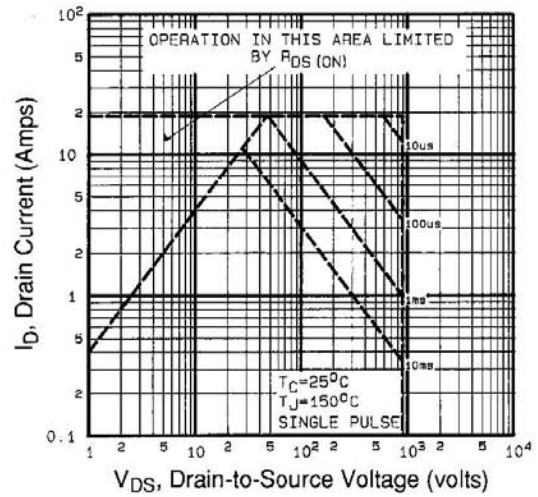

**Fig 8.** Maximum Safe Operating Area

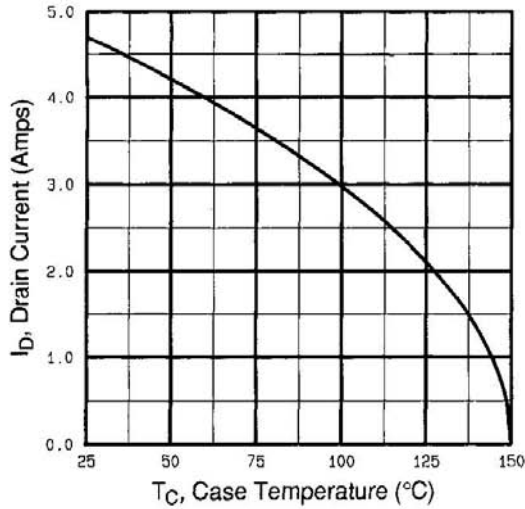

**Fig 9.** Maximum Drain Current Vs. Case Temperature

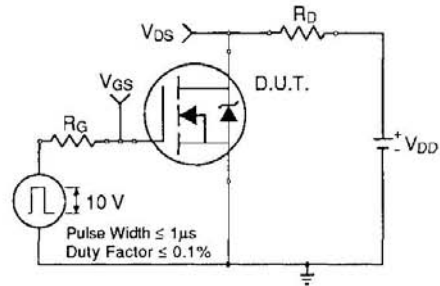

**Fig 10a.** Switching Time Test Circuit

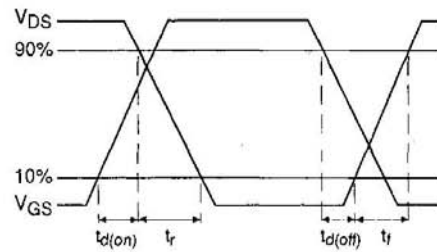

**Fig 10b.** Switching Time Waveforms

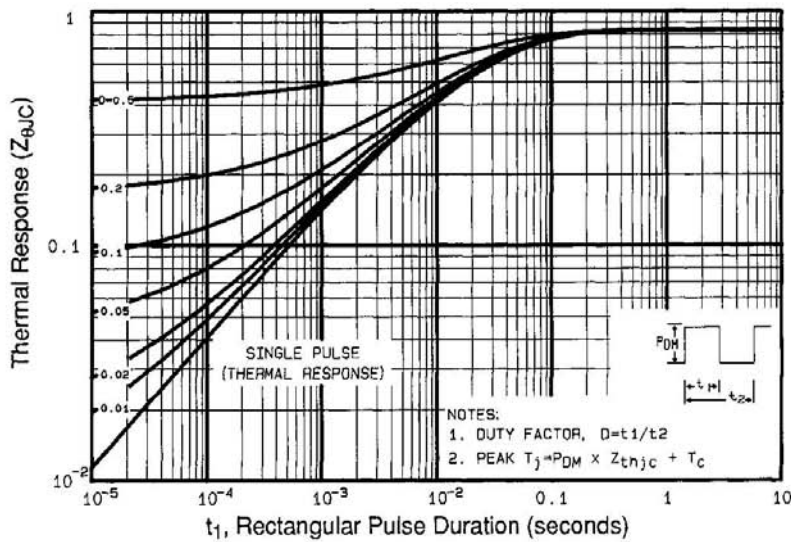

**Fig 11.** Maximum Effective Transient Thermal Impedance, Junction-to-Case

# IRFPF40PbF

International  
**IR** Rectifier

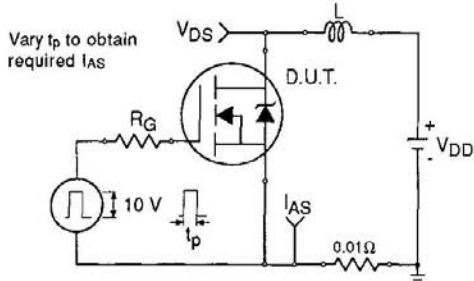

**Fig 12a.** Unclamped Inductive Test Circuit

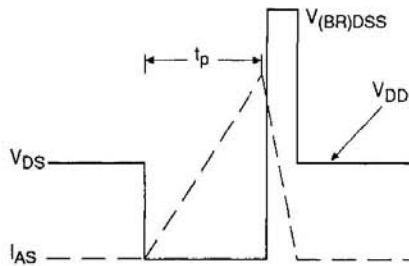

**Fig 12b.** Unclamped Inductive Waveforms

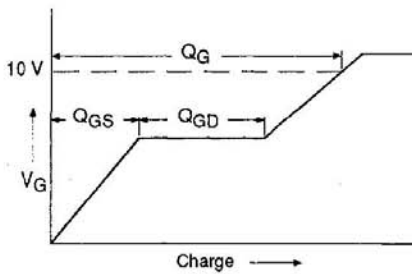

**Fig 13a.** Basic Gate Charge Waveform

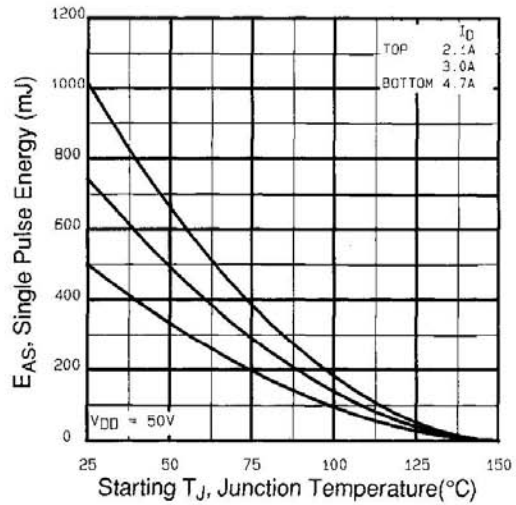

**Fig 12c.** Maximum Avalanche Energy Vs. Drain Current

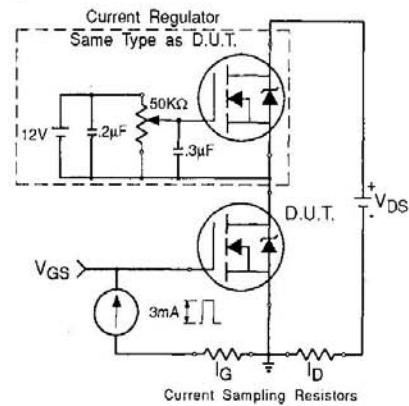

**Fig 13b.** Gate Charge Test Circuit

**Appendix A:** Figure 14, Peak Diode Recovery  $dv/dt$  Test Circuit – See page 1505

**Appendix B:** Package Outline Mechanical Drawing – See page 1511

International  
**IR** Rectifier

www.irf.com

## TO-247AC Package Outline

Dimensions are shown in millimeters (inches)

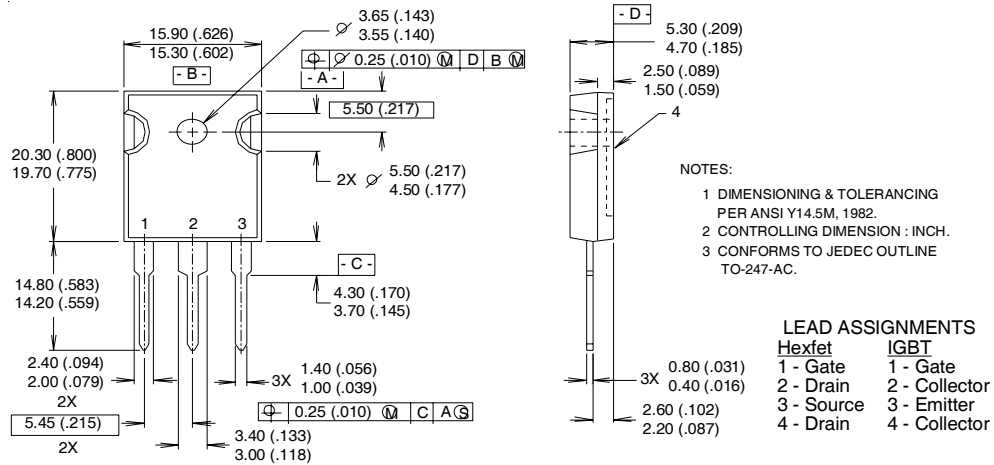

## TO-247AC Part Marking Information

EXAMPLE: THIS IS AN IRFPE30  
 WITH ASSEMBLY  
 LOT CODE 5667  
 ASSEMBLED ON WW 35, 2000  
 IN THE ASSEMBLY LINE "H"  
**Note:** "P" in assembly line  
 position indicates "Lead-Free"

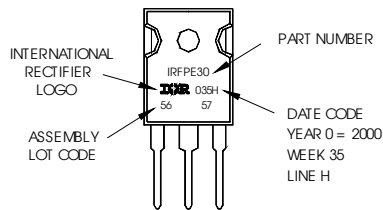

Data and specifications subject to change without notice.

Note: For the most current drawings please refer to the IR website at:  
<http://www.irf.com/package/>