

# ZXTC2062E6

## 20V, SOT23-6, complementary medium power transistors

### Summary

$BV_{CEO} > 20$  (-20)V

$BV_{ECO} > 5$  (-4)V

$I_{C(cont)} = 4$  (-3.5)A

$V_{CE(sat)} < 50$  (-65)mV @ 1A

$R_{CE(sat)} = 35$  (54)m $\Omega$

$P_D = 1.1$ W

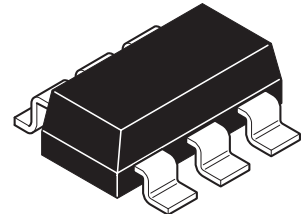

### Description

Advanced process capability has been used to achieve this high performance device. Combining NPN and PNP transistors in the SOT23-6 package provides a compact solution for the intended applications

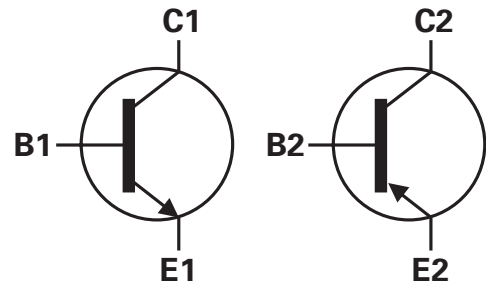

### Features

- NPN-PNP combination
- Very low saturation voltage
- High gain
- SOT23-6 package

### Applications

- MOSFET and IGBT gate driving
- Motor drive

### Ordering information

DEVICE	Reel size (inches)	Tape width (mm)	Quantity per reel
ZXTC2062E6TA	7	8	3000

### Device marking

2062

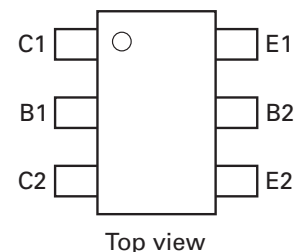

## Absolute maximum and thermal ratings

PARAMETER	Symbol	Limit	Unit
Collector-base voltage	$V_{CBO}$	100(-25)	V
Collector-emitter voltage	$V_{CEO}$	(-)20	V
Emitter-collector voltage (reverse blocking)	$V_{ECO}$	5(-4)	V
Emitter-base voltage	$V_{EBO}$	(-)7	V
Continuous collector current <sup>(c)(f)</sup>	$I_C$	4(-3.5)	A
Peak pulse current	$I_{CM}$	(-)10	A
Base current	$I_B$	(-)1	A
Power dissipation at $T_A = 25^\circ\text{C}^{(a)(f)}$ Linear derating factor	$P_D$	0.7 5.6	W mW/°C
Power dissipation at $T_A = 25^\circ\text{C}^{(b)(f)}$ Linear derating factor	$P_D$	0.9 7.2	W mW/°C
Power dissipation at $T_A = 25^\circ\text{C}^{(b)(g)}$ Linear derating factor	$P_D$	1.1 8.8	W mW/°C
Power dissipation at $T_A = 25^\circ\text{C}^{(c)(f)}$ Linear derating factor	$P_D$	1.1 8.8	W mW/°C
Power dissipation at $T_A = 25^\circ\text{C}^{(d)(f)}$ Linear derating factor	$P_D$	1.7 13.6	W mW/°C
Operating and storage temperature range	$T_j, T_{stg}$	-55 to +150	°C
Thermal resistance junction to ambient <sup>(a)(f)</sup>	$R_{\theta JA}$	179	°C/W
Thermal resistance junction to ambient <sup>(b)(f)</sup>	$R_{\theta JA}$	139	°C/W
Thermal resistance junction to ambient <sup>(b)(g)</sup>	$R_{\theta JA}$	113	°C/W
Thermal resistance junction to ambient <sup>(c)(f)</sup>	$R_{\theta JA}$	113	°C/W
Thermal resistance junction to ambient <sup>(d)(f)</sup>	$R_{\theta JA}$	73	°C/W

### NOTES:

- (a) For a device surface mounted on 15mm x 15mm x 1.6mm FR4 PCB with high coverage of single sided 1oz copper, in still air conditions.
- (b) For a device surface mounted on 25mm x 25mm x 1.6mm FR4 PCB with high coverage of single sided 1oz copper, in still air conditions.
- (c) For a device surface mounted on 50mm x 50mm x 1.6mm FR4 PCB with high coverage of single sided 2oz copper, in still air conditions.
- (d) As above measured at  $t < 5$  seconds.
- (e) Repetitive rating - pulse width limited by maximum junction temperature. Refer to Transient Thermal Impedance graph.
- (f) For device with one active die, both collectors attached to a common sink.
- (g) For device with two active dice running at equal power, split sink 50% to each collector.

## Thermal characteristics

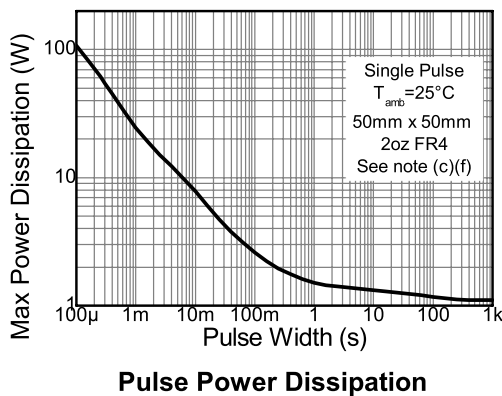
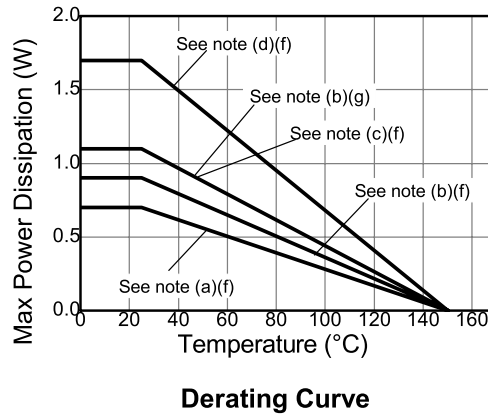
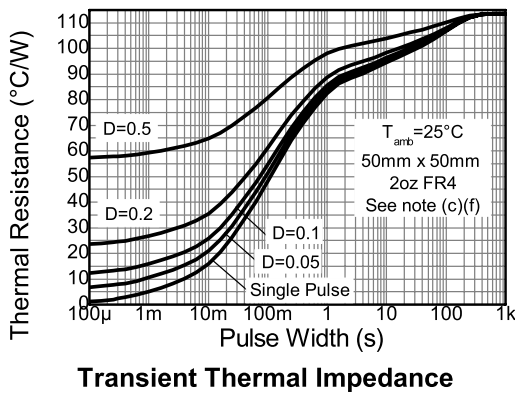
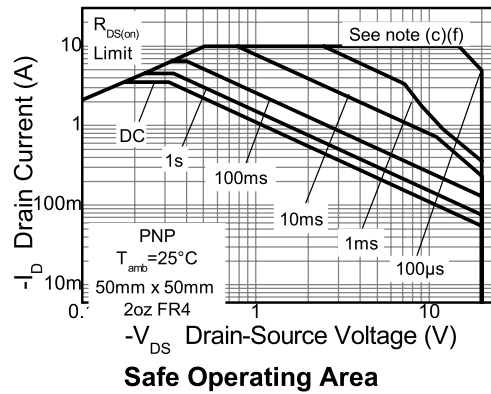
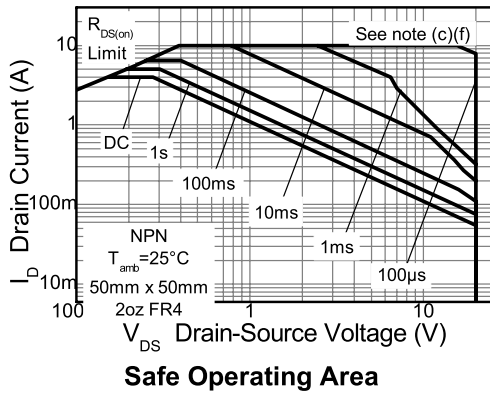

# ZXTC2062E6

## ELECTRICAL CHARACTERISTICS (at Tamb = 25°C unless otherwise stated).

Parameter	Symbol	Min.	Typ.	Max.	Unit	Conditions
		100(-25)	140(-55)		V	$I_C = (-)100\mu A$
Collector-emitter breakdown voltage (base open)	$BV_{CEO}$	(-)20	35(-45)		V	$I_C = (-)10mA^{(*)}$
Emitter-base breakdown voltage	$BV_{EBO}$	(-)7	(-)8.3		V	$I_E = (-)100 A$
Emitter-collector breakdown voltage (base open)	$BV_{ECO}$	5(-4)	6(-8.5)		V	$I_E = (-)100 A$
Collector-base cut-off current	$I_{CBO}$		<1	(-)50 (-)0.5	nA A	$V_{CB} = 100(-25)V$ $V_{CB} = 100(-25)V, T_{amb} = 100^\circ C$
Emitter-base cut-off current	$I_{EBO}$		<1	(-)50	nA	$V_{EB} = (-)5.6V$
Collector-emitter saturation voltage	$V_{CE(sat)}$		40(-55) 60(-100) 95(-185) (-190) 140	50(-65) 75(-135) 115(-280) (-250) 190	mV mV mV mV mV	$I_C = (-)1A, I_B = (-)100mA^{(*)}$ $I_C = (-)1A, I_B = (-)20mA^{(*)}$ $I_C = (-)2A, I_B = (-)40mA^{(*)}$ $(I_C = -3.5A, I_B = -175mA)^{(*)}$ $I_C = 4A, I_B = 200mA^{(*)}$
Base-emitter saturation voltage	$V_{BE(sat)}$		(-925) 940	(-1000) 1050	mV mV	$(I_C = -3.5A, I_B = -175mA)^{(*)}$ $I_C = 4A, I_B = 200mA^{(*)}$
Base-emitter turn-on voltage	$V_{BE(on)}$		(-835) 810	(-900) 900	mV mV	$(I_C = -3.5A, V_{CE} = -2V)^{(*)}$ $I_C = 4A, V_{CE} = 2V^{(*)}$
Static forward current transfer ratio	$h_{FE}$	300(300) 280(170) (65) 140	450(450) 420(300) (100) 210 (15) 15	900(900)		$I_C = (-)10mA, V_{CE} = (-)2V^{(*)}$ $I_C = (-)1A, V_{CE} = (-)2V^{(*)}$ $(I_C = -3.5A, V_{CE} = -2V)^{(*)}$ $I_C = 4A, V_{CE} = 2V^{(*)}$ $(I_C = -10A, V_{CE} = -2V)^{(*)}$ $I_C = 15A, V_{CE} = 2V^{(*)}$
Transition frequency	$f_T$		215 (290)		MHz	$I_C = (-)50mA, V_{CE} = (-)10V$ $f = 100MHz$
Output capacitance	$C_{OBO}$		17(21)	25(30)	pF	$V_{CB} = (-)10V, f = 1MHz^{(*)}$
Delay time	$t_d$		68(56)		ns	$V_{CC} = (-)10V, I_C = (-)1A,$ $I_{B1} = -I_{B2} = (-)10mA.$
Rise time	$t_r$		72(68)		ns	
Storage time	$t_s$		361(158)		ns	
Fall time	$t_f$		64(59)		ns	

### NOTES:

(\*) Measured under pulsed conditions. Pulse width  $\leq 300\mu s$ ; duty cycle  $\leq 2\%$ .

( ) = PNP

## NPN electrical characteristics

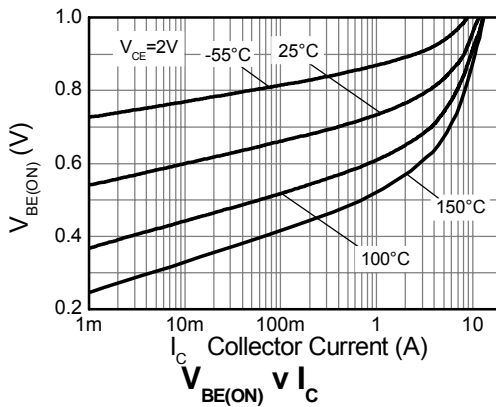
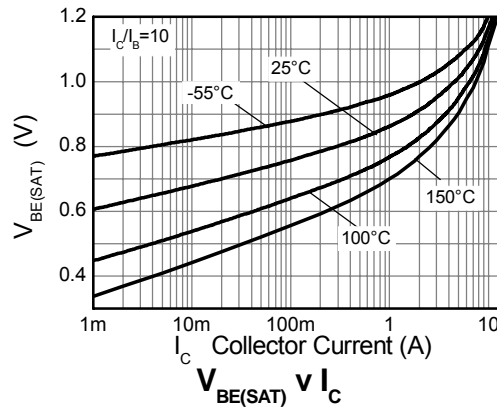
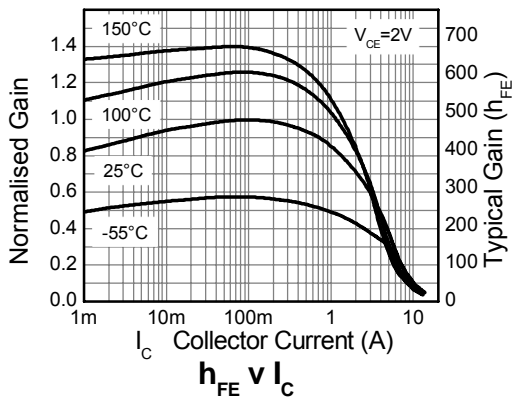
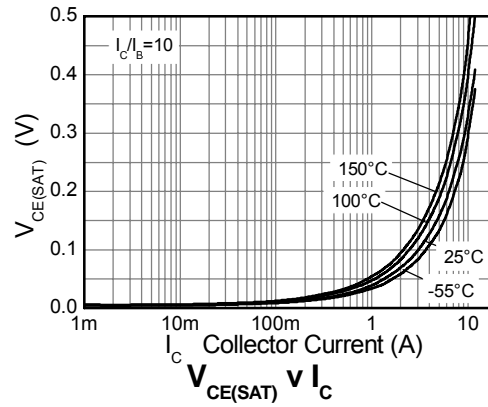
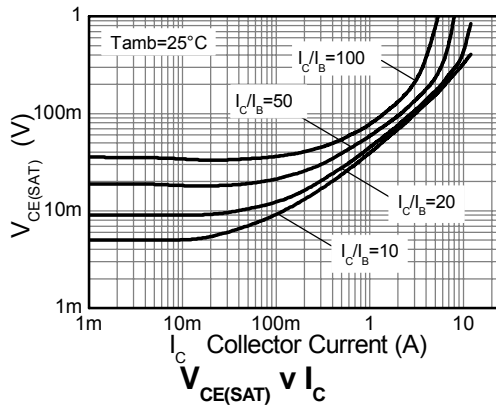

## PNP electrical characteristics

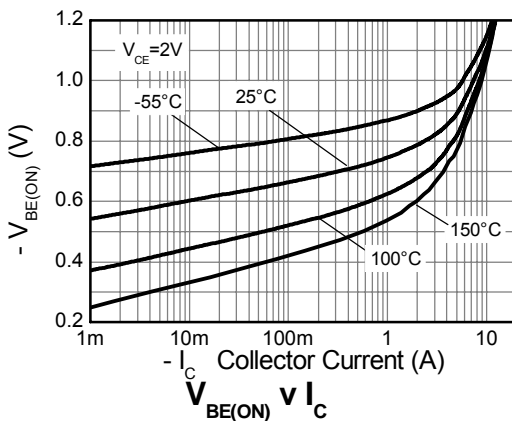
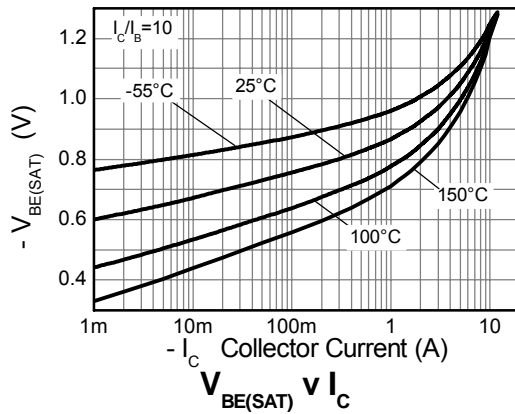
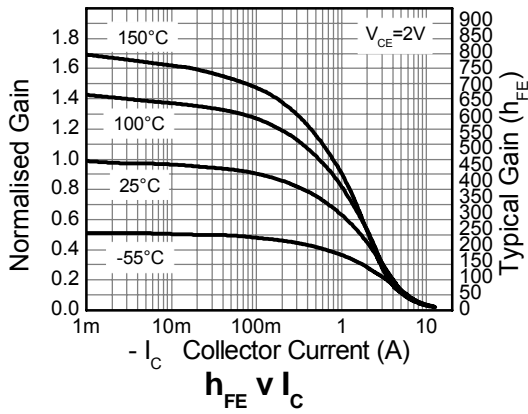
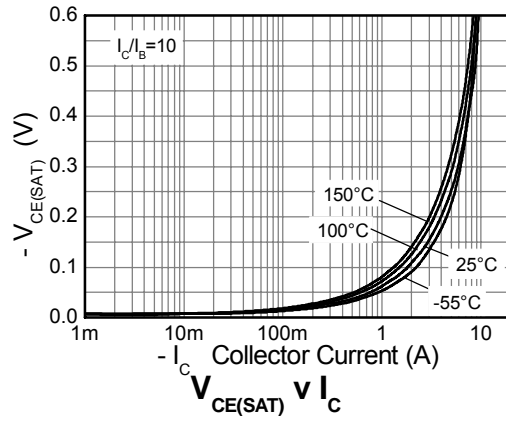
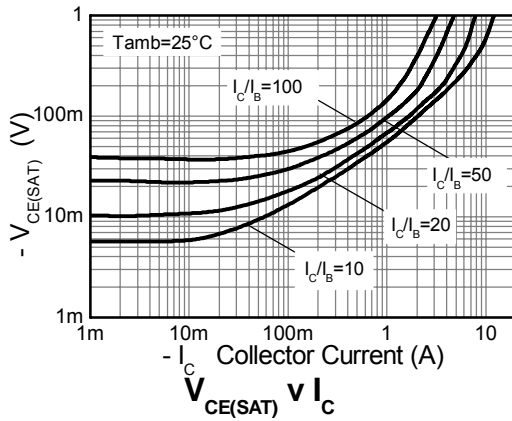

# ZXTC2062E6

## Package outline SOT23-6

### Package outline

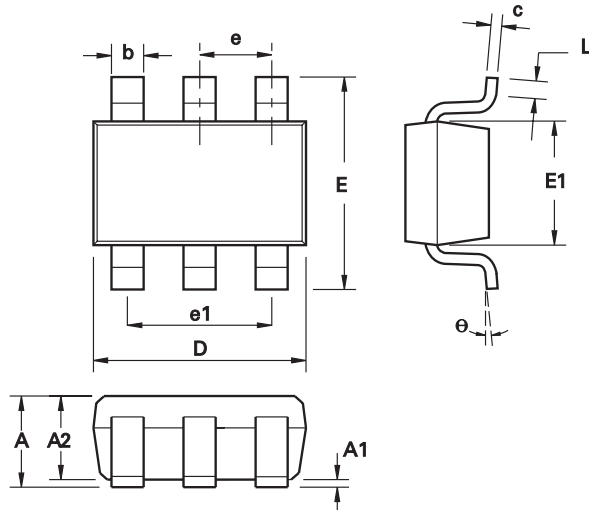

### Pad layout details

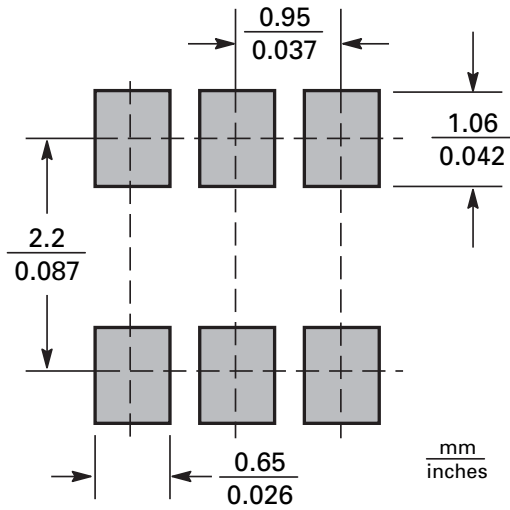

DIM	Millimeters		Inches	
	Min.	Max.	Min.	Max.
A	0.90	1.45	0.354	0.0570
A1	0.00	0.15	0.00	0.0059
A2	0.90	1.30	0.0354	0.0511
b	0.35	0.50	0.0078	0.0196
C	0.09	0.26	0.0035	0.0102
D	2.70	3.10	0.1062	0.1220
E	2.20	3.20	0.0866	0.1181
E1	1.30	1.80	0.0511	0.0708
L	0.10	0.60	0.0039	0.0236
e	0.95 REF		0.0374 REF	
e1	1.90 REF		0.0748 REF	
L	0°	30°	0°	30°

**Note:** Controlling dimensions are in millimeters. Approximate dimensions are provided in inches

---

**Definitions****Product change**

Zetex Semiconductors reserves the right to alter, without notice, specifications, design, price or conditions of supply of any product or service. Customers are solely responsible for obtaining the latest relevant information before placing orders.

**Applications disclaimer**

The circuits in this design/application note are offered as design ideas. It is the responsibility of the user to ensure that the circuit is fit for the user's application and meets with the user's requirements. No representation or warranty is given and no liability whatsoever is assumed by Zetex with respect to the accuracy or use of such information, or infringement of patents or other intellectual property rights arising from such use or otherwise. Zetex does not assume any legal responsibility or will not be held legally liable (whether in contract, tort (including negligence), breach of statutory duty, restriction or otherwise) for any damages, loss of profit, business, contract, opportunity or consequential loss in the use of these circuit applications, under any circumstances.

**Life support**

Zetex products are specifically not authorized for use as critical components in life support devices or systems without the express written approval of the Chief Executive Officer of Zetex Semiconductors plc. As used herein:

A. Life support devices or systems are devices or systems which:

1. are intended to implant into the body

or

2. support or sustain life and whose failure to perform when properly used in accordance with instructions for use provided in the labeling can be reasonably expected to result in significant injury to the user.

B. A critical component is any component in a life support device or system whose failure to perform can be reasonably expected to cause the failure of the life support device or to affect its safety or effectiveness.

**Reproduction**

The product specifications contained in this publication are issued to provide outline information only which (unless agreed by the company in writing) may not be used, applied or reproduced for any purpose or form part of any order or contract or be regarded as a representation relating to the products or services concerned.

**Terms and Conditions**

All products are sold subjects to Zetex' terms and conditions of sale, and this disclaimer (save in the event of a conflict between the two when the terms of the contract shall prevail) according to region, supplied at the time of order acknowledgement.

For the latest information on technology, delivery terms and conditions and prices, please contact your nearest Zetex sales office.

**Quality of product**

Zetex is an ISO 9001 and TS16949 certified semiconductor manufacturer.

To ensure quality of service and products we strongly advise the purchase of parts directly from Zetex Semiconductors or one of our regionally authorized distributors. For a complete listing of authorized distributors please visit: [www.zetex.com/salesnetwork](http://www.zetex.com/salesnetwork)

Zetex Semiconductors does not warrant or accept any liability whatsoever in respect of any parts purchased through unauthorized sales channels.

**ESD (Electrostatic discharge)**

Semiconductor devices are susceptible to damage by ESD. Suitable precautions should be taken when handling and transporting devices. The possible damage to devices depends on the circumstances of the handling and transporting, and the nature of the device. The extent of damage can vary from immediate functional or parametric malfunction to degradation of function or performance in use over time. Devices suspected of being affected should be replaced.

**Green compliance**

Zetex Semiconductors is committed to environmental excellence in all aspects of its operations which includes meeting or exceeding regulatory requirements with respect to the use of hazardous substances. Numerous successful programs have been implemented to reduce the use of hazardous substances and/or emissions.

All Zetex components are compliant with the RoHS directive, and through this it is supporting its customers in their compliance with WEEE and ELV directives.

**Product status key:**

"Preview"	Future device intended for production at some point. Samples may be available
"Active"	Product status recommended for new designs
"Last time buy (LTB)"	Device will be discontinued and last time buy period and delivery is in effect
"Not recommended for new designs"	Device is still in production to support existing designs and production
"Obsolete"	Production has been discontinued

**Datasheet status key:**

"Draft version"	This term denotes a very early datasheet version and contains highly provisional information, which may change in any manner without notice.
"Provisional version"	This term denotes a pre-release datasheet. It provides a clear indication of anticipated performance. However, changes to the test conditions and specifications may occur, at any time and without notice.
"Issue"	This term denotes an issued datasheet containing finalized specifications. However, changes to specifications may occur, at any time and without notice.

**Zetex sales offices**

Europe	Americas	Asia Pacific	Corporate Headquarters
Zetex GmbH Kustermann-park Balanstraße 59 D-81541 München Germany Telephone: (49) 89 45 49 49 0 Fax: (49) 89 45 49 49 49 europe.sales@zetex.com	Zetex Inc 700 Veterans Memorial Highway Hauppauge, NY 11788 USA Telephone: (1) 631 360 2222 Fax: (1) 631 360 8222 usa.sales@zetex.com	Zetex (Asia Ltd) 3701-04 Metroplaza Tower 1 Hing Fong Road, Kwai Fong Hong Kong Telephone: (852) 26100 611 Fax: (852) 24250 494 asia.sales@zetex.com	Zetex Semiconductors plc Zetex Technology Park, Chadderton Oldham, OL9 9LL United Kingdom Telephone: (44) 161 622 4444 Fax: (44) 161 622 4446 hq@zetex.com

© 2007 Published by Zetex Semiconductors plc