

# ERA37 (0.5A)

( 800, 1000V / 0.5A )

## FAST RECOVERY DIODE

### ■ Outline drawings, mm

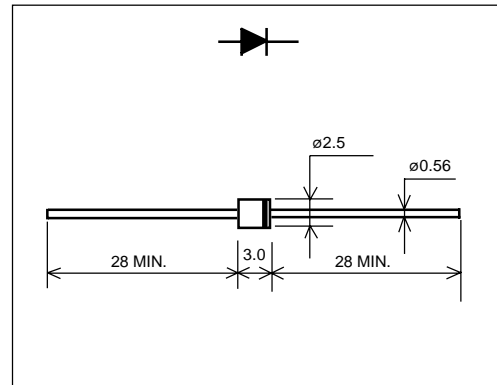

### ■ Features

- High speed switching
- Ultra small package  
Possible for 5mm pitch automatic insertion
- High reliability

### ■ Applications

- High speed switching

### ■ Maximum ratings and characteristics

- Absolute maximum ratings

Item	Symbol	Conditions	Rating		Unit
			08	10	
Repetitive peak reverse voltage	$V_{RRM}$		800	1000	V
Non-repetitive peak reverse voltage	$V_{RRM}$		800	1000	V
Average forward current	$I_{F(AV)}$	Resistive load ( $T_I = 130^\circ\text{C}$ )	0.5		A
Surge current	$I_{FSM}$	Sine wave 10ms	10		A
Operating junction temperature	$T_j$		-40 to +150		$^\circ\text{C}$
Storage temperature	$T_{stg}$		-40 to +150		$^\circ\text{C}$

- Electrical characteristics ( $T_a = 25^\circ\text{C}$  Unless otherwise specified)

Item	Symbol	Conditions	Max.	Unit
Forward voltage drop	$V_{FM}$	$I_{FM} = 0.5\text{A}$	3.0	V
Reverse current	$I_{RRM}$	$V_R = V_{RRM}$	10	$\mu\text{A}$
Reverse recovery time	$t_{rr}$	$I_F = 0.1\text{A}, I_R = 0.1\text{A}$	0.25	$\mu\text{s}$

### ■ Marking

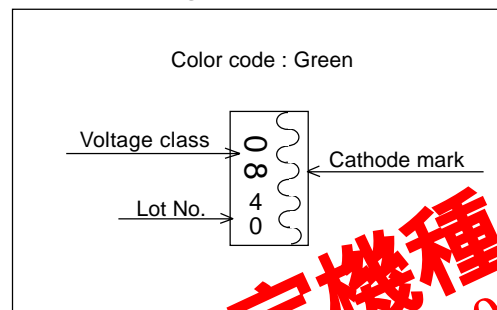

■ Characteristics

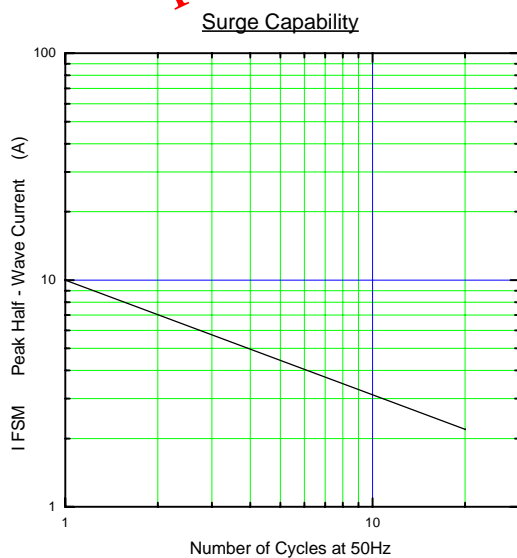
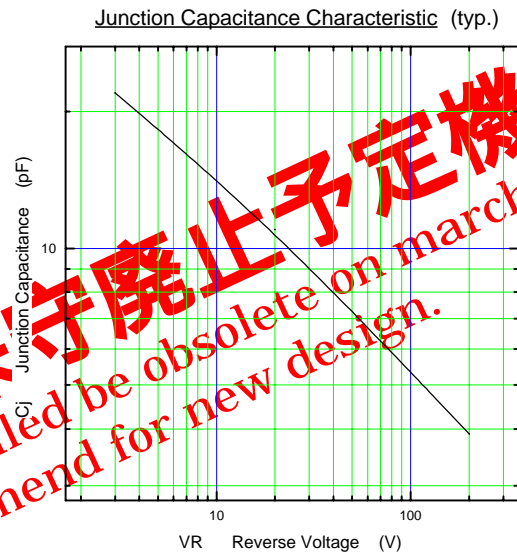
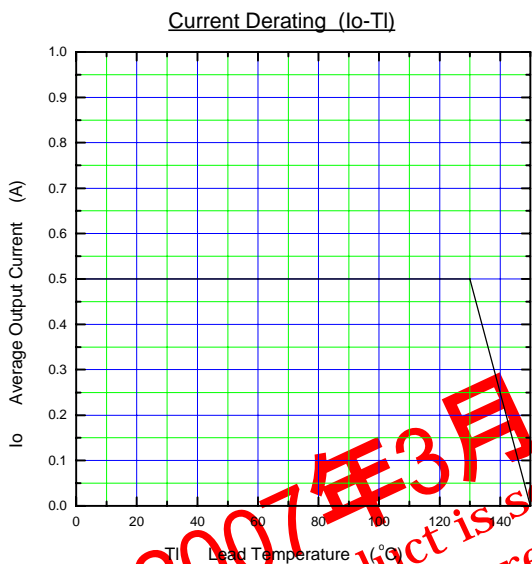
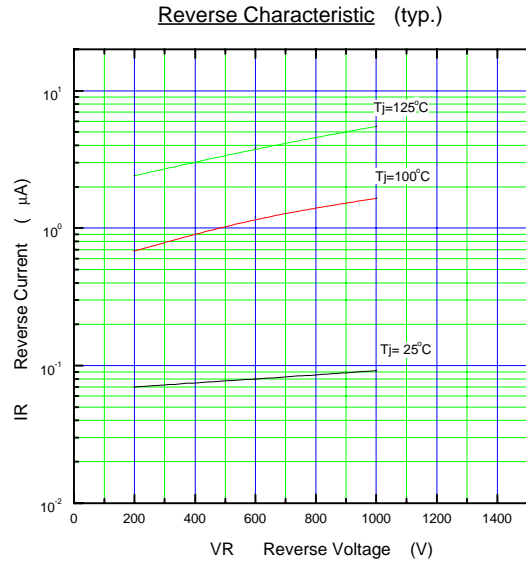
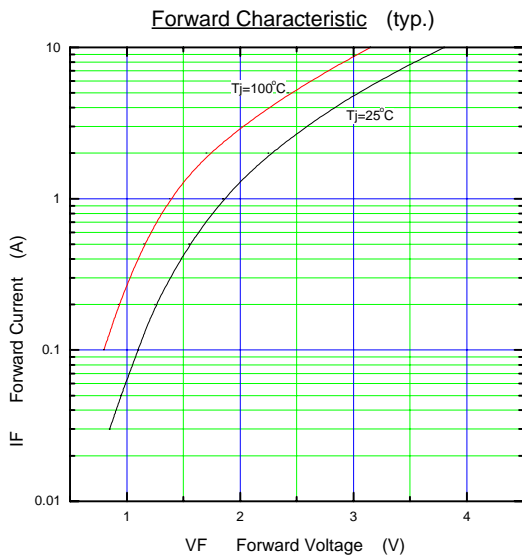

2007年3月 保守廃止予定機種  
This product is scheduled to be obsolete on march 2007.  
Not recommend for new design.