



**SEMİTOP® 1**

## IGBT Module

**SK25GB065**

Preliminary Data

### Features

- Compact design
- One screw mounting
- Heat transfer and isolation through direct copper bonded aluminium oxide ceramic (DCB)
- N-channel homogeneous silicon structure (NPT-Non punch-through IGBT)
- High short circuit capability
- Low tail current with low temperature dependence
- UL recognized, file no. E63 532

### Typical Applications

- Switching (not for linear use)
- Driver
- Switched mode power supplies
- UPS
- High switching applications (typ. >=15kHz)



**GB**

Absolute Maximum Ratings		$T_s = 25\text{ °C}$ , unless otherwise specified	
Symbol	Conditions	Values	Units
<b>IGBT</b>			
$V_{CES}$	$T_j = 25\text{ °C}$	600	V
$I_C$	$T_j = 125\text{ °C}$	$T_s = 25\text{ °C}$	30 A
		$T_s = 80\text{ °C}$	21 A
$I_{CRM}$	$I_{CRM} = 2 \times I_{Cnom}$	60	A
$V_{GES}$		$\pm 20$	V
$t_{psc}$	$V_{CC} = 300\text{ V}; V_{GE} \leq 20\text{ V}; T_j = 125\text{ °C}$ $V_{CES} < 600\text{ V}$	10	$\mu\text{s}$
<b>Inverse Diode</b>			
$I_F$	$T_j = 150\text{ °C}$	$T_s = 25\text{ °C}$	36 A
		$T_s = 80\text{ °C}$	24 A
$I_{FRM}$	$I_{FRM} = 2 \times I_{Fnom}$	70	A
$I_{FSM}$	$t_p = 10\text{ ms}; \text{half sine wave } T_j = 150\text{ °C}$	200	A
<b>Module</b>			
$I_{t(RMS)}$			A
$T_{vj}$		-40 ... +150	$^{\circ}\text{C}$
$T_{stg}$		-40 ... +125	$^{\circ}\text{C}$
$V_{isol}$	AC, 1 min.	2500	V

Characteristics		$T_s = 25\text{ °C}$ , unless otherwise specified			
Symbol	Conditions	min.	typ.	max.	Units
<b>IGBT</b>					
$V_{GE(th)}$	$V_{GE} = V_{CE}, I_C = 0,7\text{ mA}$	3	4	5	V
$I_{CES}$	$V_{GE} = 0\text{ V}, V_{CE} = V_{CES}$	$T_j = 25\text{ °C}$		0,1	mA
		$T_j = 125\text{ °C}$			mA
$I_{GES}$	$V_{CE} = 0\text{ V}, V_{GE} = 20\text{ V}$	$T_j = 25\text{ °C}$		120	nA
		$T_j = 125\text{ °C}$			nA
$V_{CE0}$		$T_j = 25\text{ °C}$	1,2	1,3	V
		$T_j = 125\text{ °C}$	1,1	0,9	V
$r_{CE}$	$V_{GE} = 15\text{ V}$	$T_j = 25\text{ °C}$	20	23	$\text{m}\Omega$
		$T_j = 125\text{ °C}$	33	43	$\text{m}\Omega$
$V_{CE(sat)}$	$I_{Cnom} = 30\text{ A}, V_{GE} = 15\text{ V}$	$T_j = 25\text{ °C}_{chiplev.}$	1,8	2	V
		$T_j = 125\text{ °C}_{chiplev.}$	2,1	2,2	V
$C_{ies}$	$V_{CE} = 25, V_{GE} = 0\text{ V}$	$f = 1\text{ MHz}$	1,6		nF
$C_{oes}$			0,15		nF
$C_{res}$			0,092		nF
$t_{d(on)}$	$R_{Gon} = 33\ \Omega$	$V_{CC} = 300\text{ V}$ $I_{Cnom} = 25\text{ A}$	30		ns
$t_r$			35		ns
$E_{on}$	$R_{Goff} = 33\ \Omega$	$T_j = 125\text{ °C}$ $V_{GE} = \pm 15\text{ V}$	0,75		mJ
$t_{d(off)}$			250		ns
$t_f$			15		ns
$E_{off}$			0,6		mJ
$R_{th(j-s)}$	per IGBT			1,4	K/W



**SEMITOP® 1**

## IGBT Module

### SK25GB065

#### Preliminary Data

#### Features

- Compact design
- One screw mounting
- Heat transfer and isolation through direct copper bonded aluminium oxide ceramic (DCB)
- N-channel homogeneous silicon structure (NPT-Non punch-through IGBT)
- High short circuit capability
- Low tail current with low temperature dependence
- UL recognized, file no. E63 532

#### Typical Applications

- Switching (not for linear use)
- Driver
- Switched mode power supplies
- UPS
- High switching applications (typ.  $\geq 15\text{kHz}$ )



**GB**

#### Characteristics

Symbol	Conditions	min.	typ.	max.	Units
<b>Inverse Diode</b>					
$V_F = V_{EC}$	$I_{Fnom} = 25\text{ A}; V_{GE} = 0\text{ V}$	$T_j = 25\text{ }^\circ\text{C}_{\text{chiplev.}}$	1,45	1,7	V
		$T_j = 125\text{ }^\circ\text{C}_{\text{chiplev.}}$	1,4	1,75	V
$V_{F0}$			0,85	0,9	V
$r_F$			22	32	m $\Omega$
$I_{RRM}$	$I_{Fnom} = 25\text{ A}$		16		A
$Q_{rr}$	$di/dt = -500\text{ A}/\mu\text{s}$		2		$\mu\text{C}$
$E_{rr}$	$V_{CC} = 300\text{ V}$		0,25		mJ
$R_{th(j-s)D}$	per diode			1,7	K/W
$M_s$	to heat sink			1,5	Nm
w			13		g

This is an electrostatic discharge sensitive device (ESDS), international standard IEC 60747-1, Chapter IX.

This technical information specifies semiconductor devices but promises no characteristics. No warranty or guarantee expressed or implied is made regarding delivery, performance or suitability.

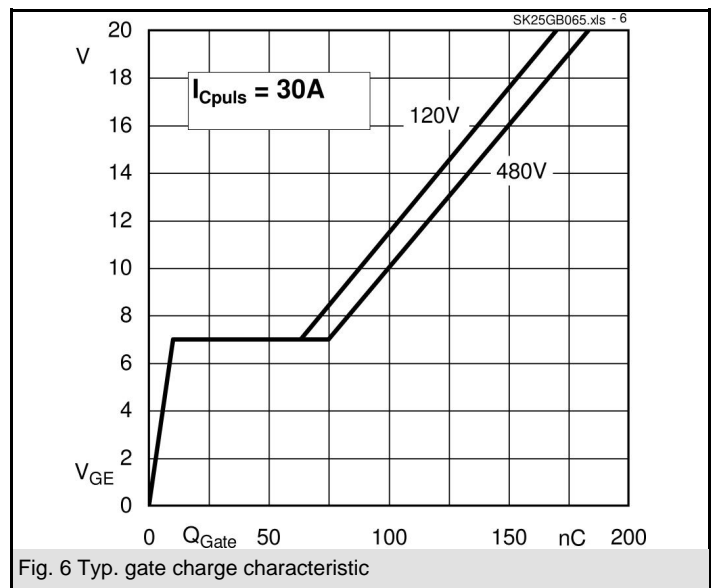
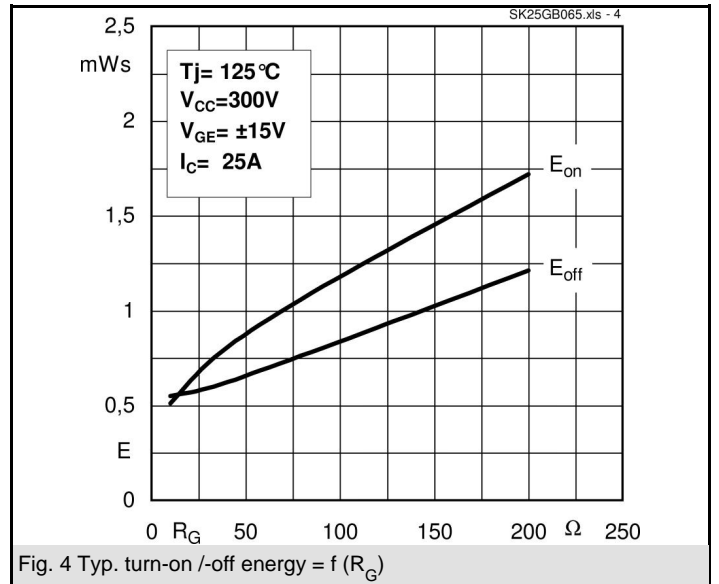
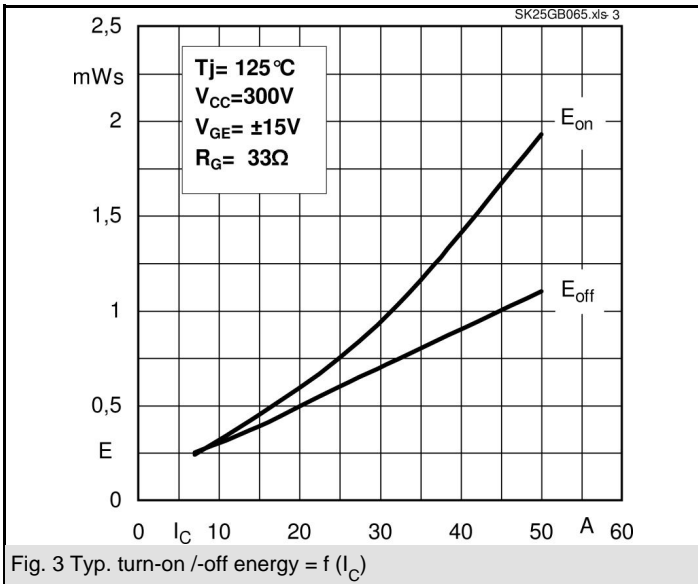
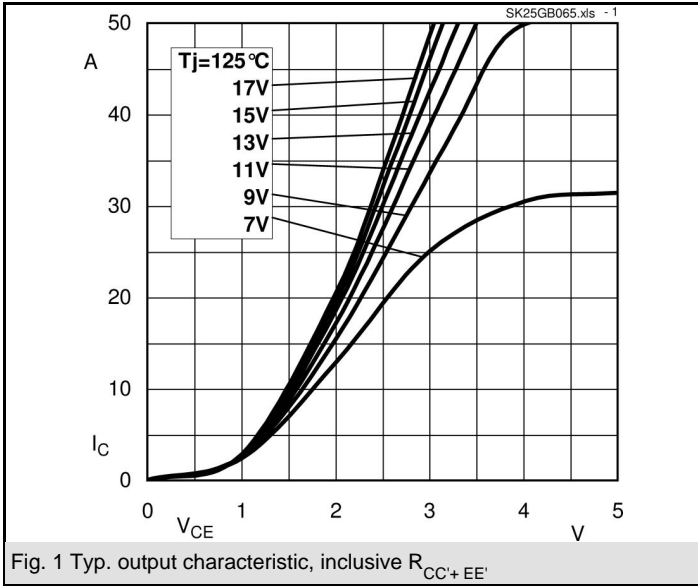

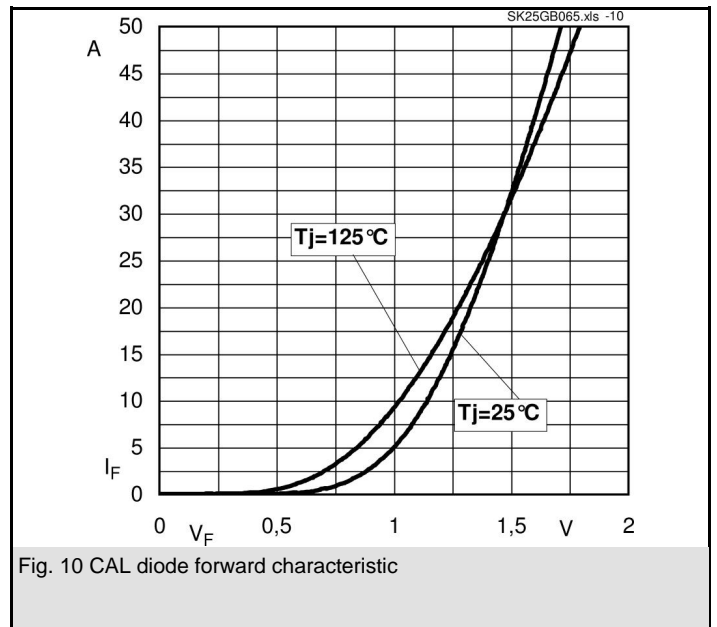
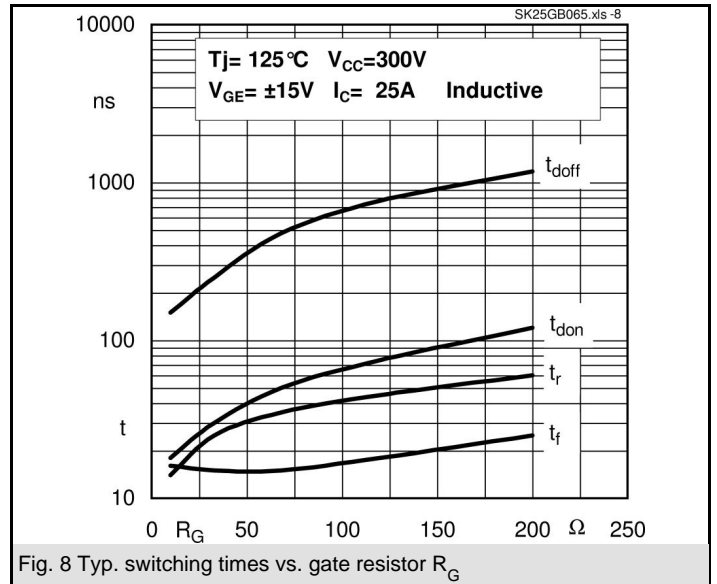
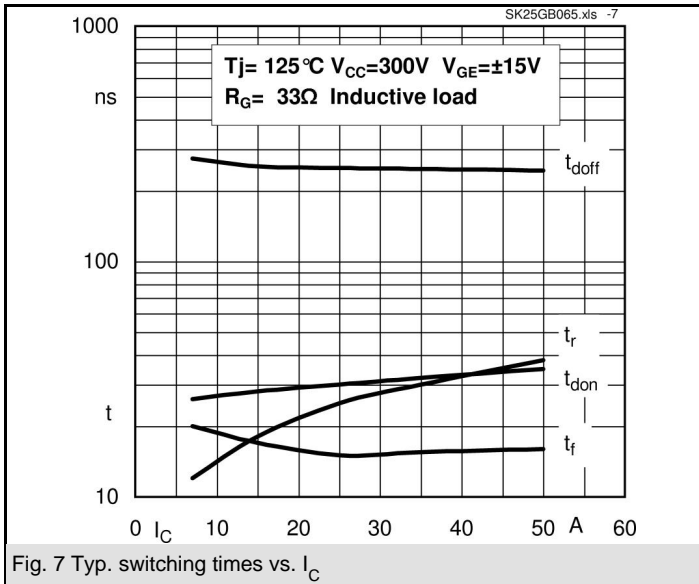

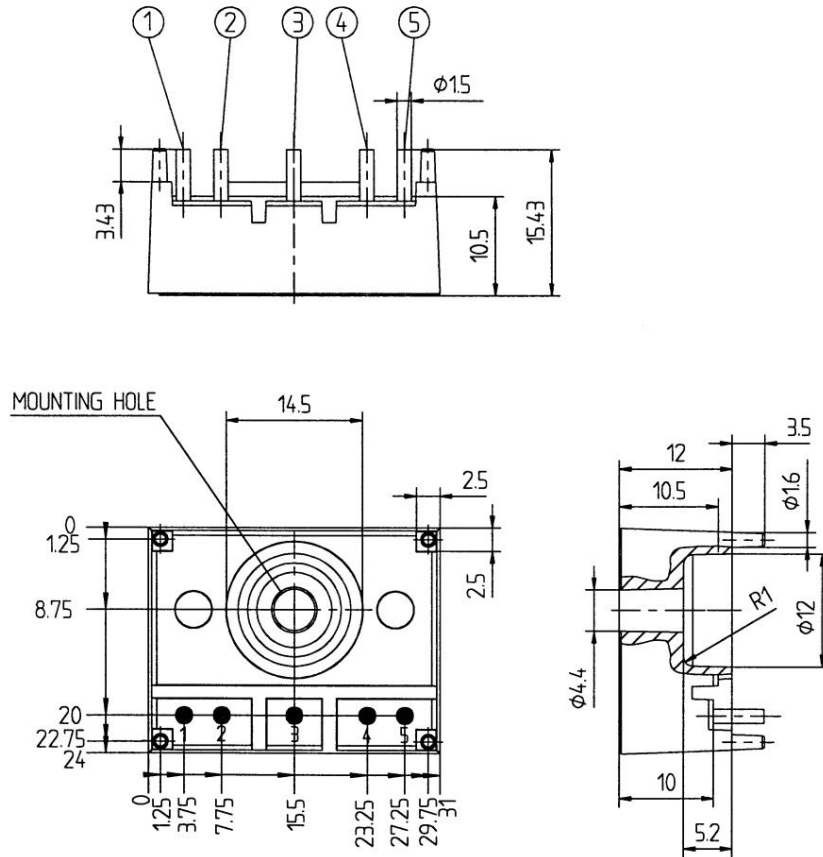

Case T3 (Suggested hole diameter, in the PCB, for solder pins and plastic mounting pins: 2mm)

