



SMT inductors

SIMID series, SIMID 1008-A

Series/Type: **B82494A**
Date: **March 2008**

SIMID 1008-A

SMD

Size 1008 (EIA) or 2520 (IEC)
Rated inductance 0.010 μ H to 100 μ H
Rated current 60 mA to 280 mA



Construction

- Ferrite core
- Molded epoxy encapsulation

Features

- High Q factor
- High resonance frequency
- Suitable for reflow soldering
- Non-automotive
- RoHS-compatible

Applications

- Filtering of supply voltages, coupling, decoupling
- Antenna systems
- Telecommunications

Terminals

- Base material phosphor bronze
- Layer composition SnCu (lead-free)
- Electro-plated

Marking

- Marking on component:
L value (in μ H)
- Minimum data on reel:
Manufacturer, ordering code, L value,
quantity, date of packing

Delivery mode and packing unit

- 8-mm blister tape, wound on 180-mm \varnothing reel
- Packing unit: 2000 pcs./reel

SIMID 1008-A

SMD

Dimensional drawing and layout recommendation

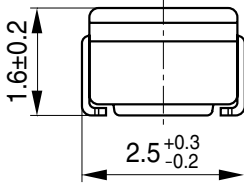
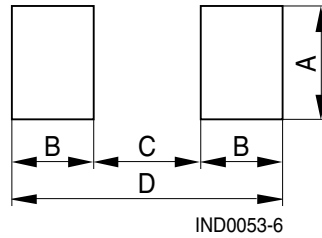
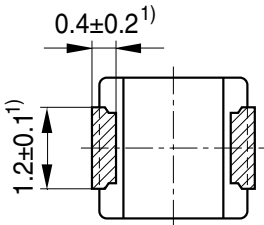

A	B	C	D
1.6	1.05	1.5	3.5

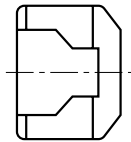
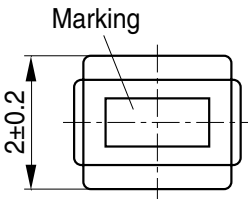

1) Soldering area

IND0543-T-E

Dimensions in mm

Taping and packing

Blister tape

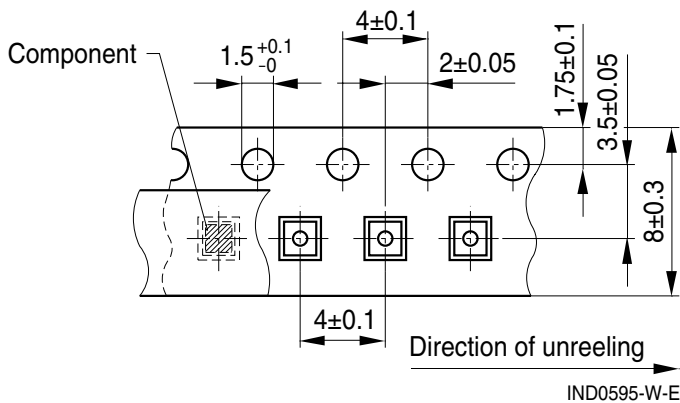

Reel

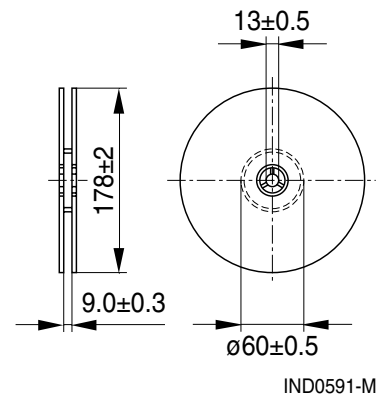

Dimensions in mm

Technical data and measuring conditions

Rated inductance L_R	Measured with impedance analyzer Agilent 4191A at frequency f_L , 0.1 V, 20 °C
Q factor Q_{\min}	Measured with impedance analyzer Agilent 4191A at frequency f_Q , 20 °C
Rated temperature T_R	85 °C
Rated current I_R	Maximum permissible DC with inductance decrease $\Delta L/L_0 \leq 10\%$ and temperature increase of ≤ 20 K at rated temperature
Self-resonance frequency $f_{\text{res,min}}$	Measured with network analyzer Agilent 8753D, 20 °C
DC resistance R_{\max}	Measured at 20 °C
Solderability (lead-free)	Sn95.5Ag3.8Cu0.7: (245 ±5) °C, (5 ±0.3) s Wetting of soldering area $\geq 90\%$ (based on IEC 60068-2-58)
Resistance to soldering heat	260 °C, 10 s (based on IEC 60068-2-58)
Climatic category	55/085/56 (to IEC 60068-1)
Storage conditions	Mounted: -55 °C ... +85 °C Packaged: -25 °C ... +40 °C, $\leq 75\%$ RH
Weight	Approx. 21 mg

Characteristics and ordering codes

L_R μH	Tolerance	Q_{\min}	$f_L; f_Q$ MHz	I_R mA	R_{\max} Ω	$f_{\text{res,min}}$ MHz	Ordering code
0.010	$\pm 10\% \triangleq K$	10	100	280	0.32	2500	B82494A1100K000
0.012		10	100	270	0.34	2200	B82494A1120K000
0.015		10	100	255	0.38	1800	B82494A1150K000
0.018		10	100	250	0.40	1550	B82494A1180K000
0.022		15	100	240	0.43	1350	B82494A1220K000
0.027		15	100	230	0.47	1150	B82494A1270K000
0.033		15	100	220	0.51	1000	B82494A1330K000
0.039		15	100	215	0.55	890	B82494A1390K000
0.047		15	100	205	0.59	770	B82494A1470K000
0.056		15	100	200	0.63	670	B82494A1560K000
0.068		15	100	190	0.68	590	B82494A1680K000
0.082		15	100	185	0.73	520	B82494A1820K000
0.10		10	25.2	175	0.80	460	B82494A1101K000
0.12		10	25.2	170	0.87	400	B82494A1121K000
0.15		10	25.2	160	0.98	340	B82494A1151K000

Characteristics and ordering codes

L_R μH	Tolerance	Q_{\min}	$f_L; f_Q$ MHz	I_R mA	R_{\max} Ω	$f_{\text{res,min}}$ MHz	Ordering code
0.18	$\pm 10\% \triangleq K$	10	25.2	155	1.05	300	B82494A1181K000
0.22		25	25.2	190	0.70	230	B82494A1221K000
0.27		25	25.2	180	0.75	210	B82494A1271K000
0.33		25	25.2	170	0.85	190	B82494A1331K000
0.39		25	25.2	160	0.95	175	B82494A1391K000
0.47		25	25.2	155	1.00	160	B82494A1471K000
0.56		25	25.2	150	1.10	150	B82494A1561K000
0.68		25	25.2	140	1.25	135	B82494A1681K000
0.82		25	25.2	130	1.40	125	B82494A1821K000
1.0		25	7.96	195	0.65	115	B82494A1102K000
1.2		25	7.96	180	0.75	100	B82494A1122K000
1.5		25	7.96	170	0.85	90	B82494A1152K000
1.8		25	7.96	160	0.95	85	B82494A1182K000
2.2		25	7.96	155	1.05	80	B82494A1222K000
2.7		25	7.96	145	1.20	75	B82494A1272K000
3.3		25	7.96	135	1.30	65	B82494A1332K000
3.9		25	7.96	130	1.40	60	B82494A1392K000
4.7		25	7.96	125	1.55	55	B82494A1472K000
5.6		25	7.96	120	1.75	50	B82494A1562K000
6.8	25	7.96	115	1.95	45	B82494A1682K000	
8.2	25	7.96	105	2.2	40	B82494A1822K000	
10	25	2.52	80	3.5	32	B82494A1103K000	
12	25	2.52	75	3.8	30	B82494A1123K000	
15	25	2.52	70	4.4	28	B82494A1153K000	
18	25	2.52	65	5.0	25	B82494A1183K000	
22	25	2.52	60	5.8	22	B82494A1223K000	
27	20	2.52	115	6.3	21	B82494A1273K000	
33	20	2.52	110	7.1	20	B82494A1333K000	
39	20	2.52	90	9.5	18	B82494A1393K000	
47	20	2.52	80	11.0	17	B82494A1473K000	
56	20	2.52	75	12.1	16	B82494A1563K000	
68	20	2.52	70	16.6	15	B82494A1683K000	
82	20	2.52	65	19.0	13	B82494A1823K000	
100	15	0.796	60	21.0	12	B82494A1104K000	

Cautions and warnings

- Please note the recommendations in our Inductors data book (latest edition) and in the data sheets.
 - Particular attention should be paid to the derating curves given there.
 - The soldering conditions should also be observed. Temperatures quoted in relation to wave soldering refer to the pin, not the housing.
- If the components are to be washed varnished it is necessary to check whether the washing varnish agent that is used has a negative effect on the wire insulation, any plastics that are used, or on glued joints. In particular, it is possible for washing varnish agent residues to have a negative effect in the long-term on wire insulation.
- The following points must be observed if the components are potted in customer applications:
 - Many potting materials shrink as they harden. They therefore exert a pressure on the plastic housing or core. This pressure can have a deleterious effect on electrical properties, and in extreme cases can damage the core or plastic housing mechanically.
 - It is necessary to check whether the potting material used attacks or destroys the wire insulation, plastics or glue.
 - The effect of the potting material can change the high-frequency behaviour of the components.
- Ferrites are sensitive to direct impact. This can cause the core material to flake, or lead to breakage of the core.
- Even for customer-specific products, conclusive validation of the component in the circuit can only be carried out by the customer.

Important notes

The following applies to all products named in this publication:

1. Some parts of this publication contain **statements about the suitability of our products for certain areas of application**. These statements are based on our knowledge of typical requirements that are often placed on our products in the areas of application concerned. We nevertheless expressly point out **that such statements cannot be regarded as binding statements about the suitability of our products for a particular customer application**.

As a rule, EPCOS is either unfamiliar with individual customer applications or less familiar with them than the customers themselves. For these reasons, it is always ultimately incumbent on the customer to check and decide whether an EPCOS product with the properties described in the product specification is suitable for use in a particular customer application.

2. We also point out that **in individual cases, a malfunction of passive electronic components or failure before the end of their usual service life cannot be completely ruled out in the current state of the art, even if they are operated as specified**. In customer applications requiring a very high level of operational safety and especially in customer applications in which the malfunction or failure of a passive electronic component could endanger human life or health (e.g. in accident prevention or life-saving systems), it must therefore be ensured by means of suitable design of the customer application or other action taken by the customer (e.g. installation of protective circuitry or redundancy) that no injury or damage is sustained by third parties in the event of malfunction or failure of a passive electronic component.
3. **The warnings, cautions and product-specific notes must be observed.**
4. In order to satisfy certain technical requirements, **some of the products described in this publication may contain substances subject to restrictions in certain jurisdictions (e.g. because they are classed as hazardous)**. Useful information on this will be found in our Material Data Sheets on the Internet (www.epcos.com/material). Should you have any more detailed questions, please contact our sales offices.
5. We constantly strive to improve our products. Consequently, **the products described in this publication may change from time to time**. The same is true of the corresponding product specifications. Please check therefore to what extent product descriptions and specifications contained in this publication are still applicable before or when you place an order.

We also **reserve the right to discontinue production and delivery of products**. Consequently, we cannot guarantee that all products named in this publication will always be available.

The aforementioned does not apply in the case of individual agreements deviating from the foregoing for customer-specific products.

6. Unless otherwise agreed in individual contracts, **all orders are subject to the current version of the “General Terms of Delivery for Products and Services in the Electrical Industry” published by the German Electrical and Electronics Industry Association (ZVEI)**.
7. The trade names EPCOS, BAOKE, Alu-X, CeraDiode, CSSP, CTVS, DSSP, MiniBlue, MKK, MLSC, MotorCap, PCC, PhaseCap, PhaseMod, SIFERRIT, SIFI, SIKOREL, SilverCap, SIMDAD, SIMID, SineFormer, SIOV, SIP5D, SIP5K, ThermoFuse, WindCap are **trademarks registered or pending** in Europe and in other countries. Further information will be found on the Internet at www.epcos.com/trademarks.