

## P-Channel 1.8-V (G-S) MOSFET With Schottky Diode

MOSFET PRODUCT SUMMARY		
$V_{DS}$ (V)	$r_{DS(on)}$ ( $\Omega$ )	$I_D$ (A)
-20	0.110 @ $V_{GS} = -4.5$ V	-3.6
	0.160 @ $V_{GS} = -2.5$ V	-3.0
	0.240 @ $V_{GS} = -1.8$ V	-2.4

SCHOTTKY PRODUCT SUMMARY		
$V_{KA}$ (V)	$V_f$ (V) Diode Forward Voltage	$I_F$ (A)
20	0.375 V @ 1 A	1.0

### FEATURES

- TrenchFET® Power MOSFETS
- Ultra Low  $V_f$  Schottky
- Si5853DC Pin Compatible

### APPLICATIONS

- Charging Circuit in Portable Devices

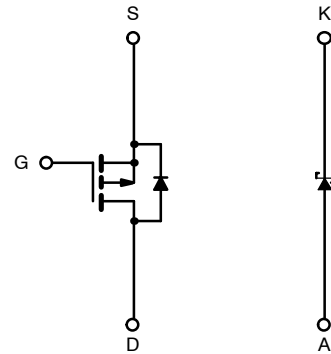
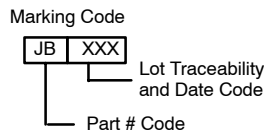
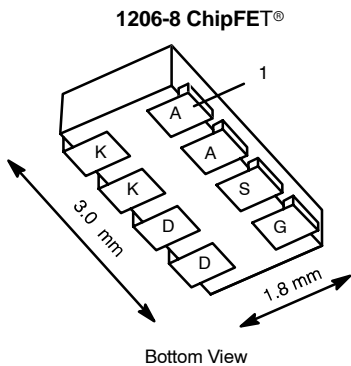

**Ordering Information:** Si5855DC-T1  
Si5855DC-T1—E3 (Lead Free)

ABSOLUTE MAXIMUM RATINGS ( $T_A = 25^\circ\text{C}$ UNLESS OTHERWISE NOTED)					
Parameter	Symbol	5 sec	Steady State	Unit	
Drain-Source Voltage (MOSFET)	$V_{DS}$	-20		V	
Reverse Voltage (Schottky)	$V_{KA}$	20			
Gate-Source Voltage (MOSFET)	$V_{GS}$	$\pm 8$			
Continuous Drain Current ( $T_J = 150^\circ\text{C}$ ) (MOSFET) <sup>a</sup>	$I_D$	$T_A = 25^\circ\text{C}$	-3.6	-2.7	A
		$T_A = 85^\circ\text{C}$	-2.6	-1.9	
Pulsed Drain Current (MOSFET)	$I_{DM}$	-10			
Continuous Source Current (MOSFET Diode Conduction) <sup>a</sup>	$I_S$	-1.8	-0.9		
Average Forward Current (Schottky)	$I_F$	1.0			
Pulsed Forward Current (Schottky)	$I_{FM}$	7			
Maximum Power Dissipation (MOSFET) <sup>a</sup>	$P_D$	$T_A = 25^\circ\text{C}$	2.1	1.1	
		$T_A = 85^\circ\text{C}$	1.1	0.6	
Maximum Power Dissipation (Schottky) <sup>a</sup>	$P_D$	$T_A = 25^\circ\text{C}$	1.9	1.1	
		$T_A = 85^\circ\text{C}$	1.0	0.56	
Operating Junction and Storage Temperature Range	$T_J, T_{stg}$	-55 to 150		$^\circ\text{C}$	
Soldering Recommendations (Peak Temperature) <sup>b, c</sup>		260			

**Notes**

- Surface Mounted on 1" x 1" FR4 Board.
- See Reliability Manual for profile. The ChipFET is a leadless package. The end of the lead terminal is exposed copper (not plated) as a result of the singulation process in manufacturing. A solder fillet at the exposed copper tip cannot be guaranteed and is not required to ensure adequate bottom side solder interconnection.
- Rework Conditions: manual soldering with a soldering iron is not recommended for leadless components.

THERMAL RESISTANCE RATINGS						
Parameter		Device	Symbol	Typical	Maximum	Unit
Junction-to-Ambient <sup>a</sup>	$t \leq 5 \text{ sec}$	MOSFET	$R_{thJA}$	50	60	°C/W
		Schottky		54	65	
	Steady State	MOSFET		90	110	
		Schottky		95	115	
Junction-to-Foot	Steady State	MOSFET	$R_{thJF}$	30	40	
		Schottky		30	40	

## Notes

a. Surface Mounted on 1" x 1" FR4 Board.

MOSFET SPECIFICATIONS ( $T_J = 25^\circ\text{C}$ UNLESS OTHERWISE NOTED)						
Parameter	Symbol	Test Condition	Min	Typ	Max	Unit
<b>Static</b>						
Gate Threshold Voltage	$V_{GS(th)}$	$V_{DS} = V_{GS}, I_D = -250 \mu\text{A}$	-0.45		-1.0	V
Gate-Body Leakage	$I_{GSS}$	$V_{DS} = 0 \text{ V}, V_{GS} = \pm 8 \text{ V}$			$\pm 100$	nA
Zero Gate Voltage Drain Current	$I_{DSS}$	$V_{DS} = -20 \text{ V}, V_{GS} = 0 \text{ V}$			-1	$\mu\text{A}$
		$V_{DS} = -20 \text{ V}, V_{GS} = 0 \text{ V}, T_J = 85^\circ\text{C}$			-5	
On-State Drain Current <sup>a</sup>	$I_{D(on)}$	$V_{DS} \leq -5 \text{ V}, V_{GS} = -4.5 \text{ V}$	-10			A
Drain-Source On-State Resistance <sup>a</sup>	$r_{DS(on)}$	$V_{GS} = -4.5 \text{ V}, I_D = -2.7 \text{ A}$		0.095	0.110	$\Omega$
		$V_{GS} = -2.5 \text{ V}, I_D = -2.2 \text{ A}$		0.137	0.160	
		$V_{GS} = -1.8 \text{ V}, I_D = -1 \text{ A}$		0.205	0.240	
Forward Transconductance <sup>a</sup>	$g_{fs}$	$V_{DS} = -10 \text{ V}, I_D = -2.7 \text{ A}$		7		S
Diode Forward Voltage <sup>a</sup>	$V_{SD}$	$I_S = -0.9 \text{ A}, V_{GS} = 0 \text{ V}$		-0.8	-1.2	V
<b>Dynamic<sup>b</sup></b>						
Total Gate Charge	$Q_g$	$V_{DS} = -10 \text{ V}, V_{GS} = -4.5 \text{ V}, I_D = -2.7 \text{ A}$		5.1	7.7	nC
Gate-Source Charge	$Q_{gs}$		1.2			
Gate-Drain Charge	$Q_{gd}$		1.0			
Turn-On Delay Time	$t_{d(on)}$	$V_{DD} = -10 \text{ V}, R_L = 10 \Omega$ $I_D \cong -1 \text{ A}, V_{GEN} = -4.5 \text{ V}, R_g = 6 \Omega$		16	25	ns
Rise Time	$t_r$		30	45		
Turn-Off Delay Time	$t_{d(off)}$		30	45		
Fall Time	$t_f$		27	40		
Source-Drain Reverse Recovery Time	$t_{rr}$	$I_F = -0.9 \text{ A}, di/dt = 100 \text{ A}/\mu\text{s}$		20	40	

## Notes

a. Pulse test; pulse width  $\leq 300 \mu\text{s}$ , duty cycle  $\leq 2\%$ .

b. Guaranteed by design, not subject to production testing.

SCHOTTKY SPECIFICATIONS ( $T_J = 25^\circ\text{C}$ UNLESS OTHERWISE NOTED)						
Parameter	Symbol	Test Condition	Min	Typ	Max	Unit
Forward Voltage Drop	$V_F$	$I_F = 1 \text{ A}$		0.34	0.375	V
		$I_F = 1 \text{ A}, T_J = 125^\circ\text{C}$		0.255	0.290	
Maximum Reverse Leakage Current	$I_{rm}$	$V_r = 20 \text{ V}$		0.05	0.500	mA
		$V_r = 20 \text{ V}, T_J = 85^\circ\text{C}$		2	20	
		$V_r = 20 \text{ V}, T_J = 125^\circ\text{C}$		10	100	
Junction Capacitance	$C_T$	$V_r = 10 \text{ V}$		90		pF



**TYPICAL CHARACTERISTICS (25 °C UNLESS NOTED)**

**MOSFET**

**Output Characteristics**

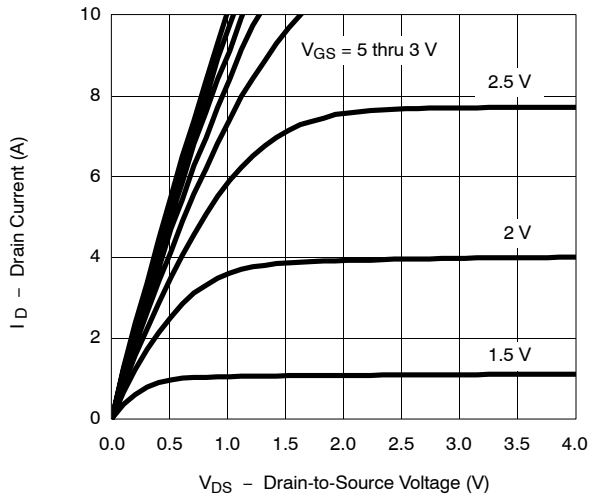

**Transfer Characteristics**

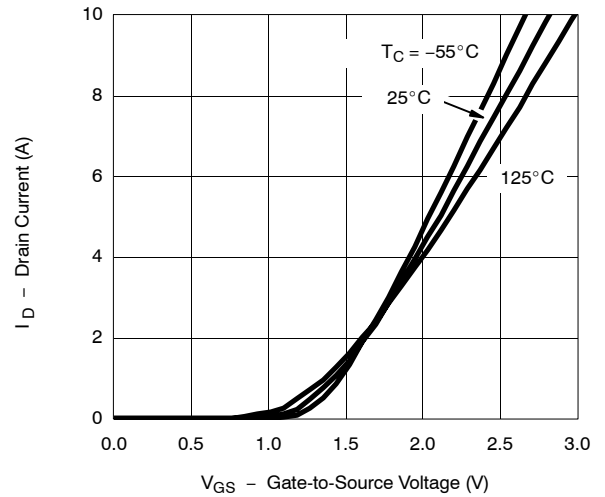

**On-Resistance vs. Drain Current**

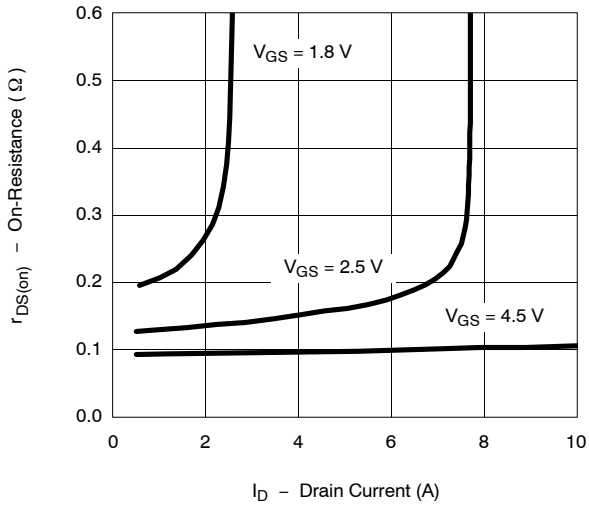

**Capacitance**

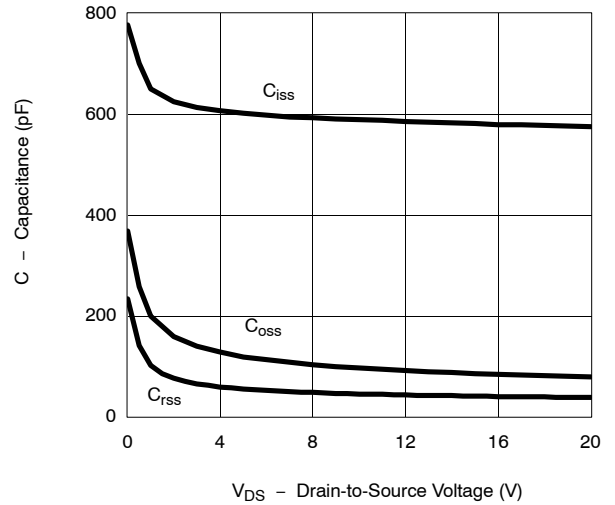

**Gate Charge**

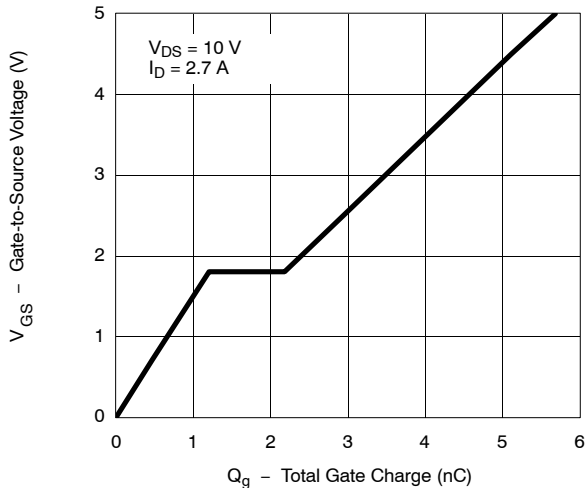

**On-Resistance vs. Junction Temperature**

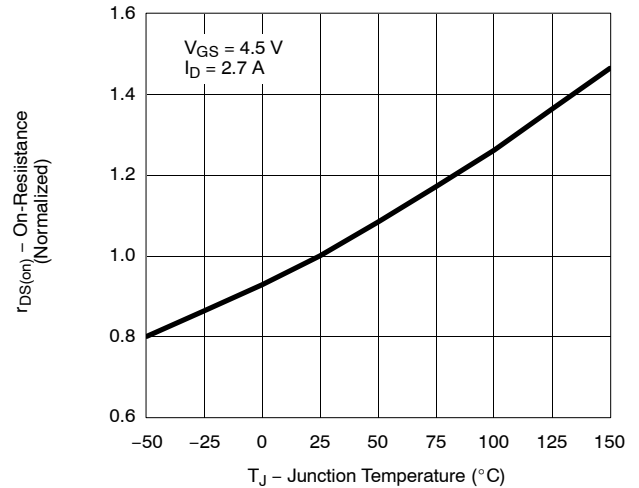

**TYPICAL CHARACTERISTICS (25 °C UNLESS NOTED) MOSFET**

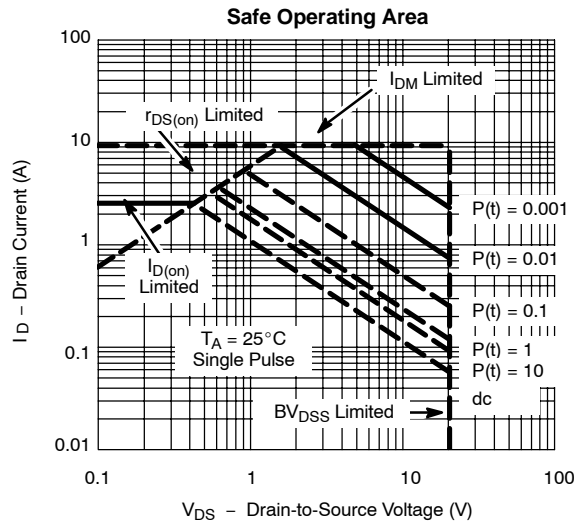
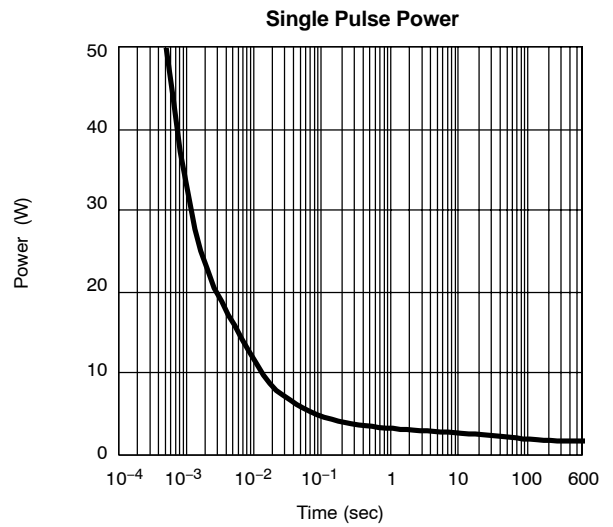
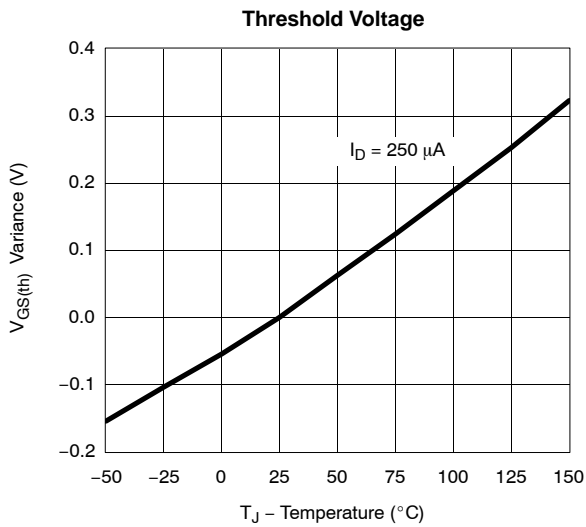
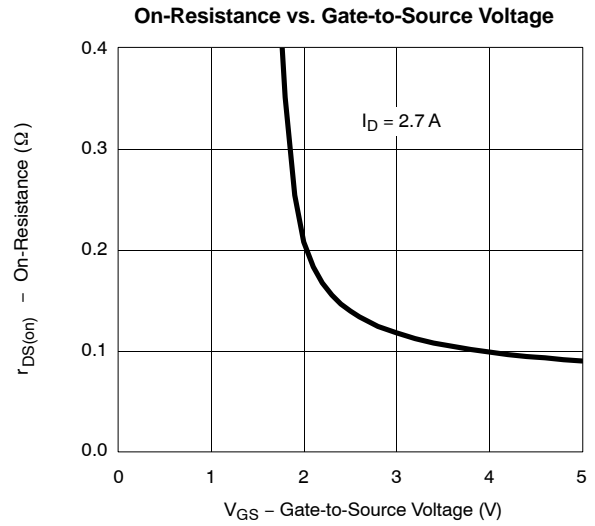
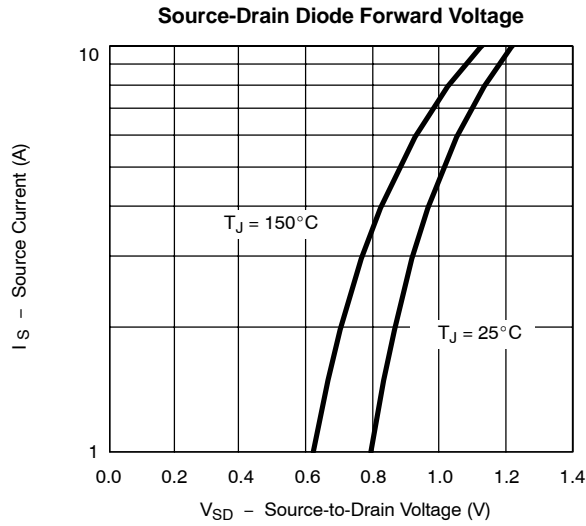

**TYPICAL CHARACTERISTICS (25°C UNLESS NOTED)**

**MOSFET**

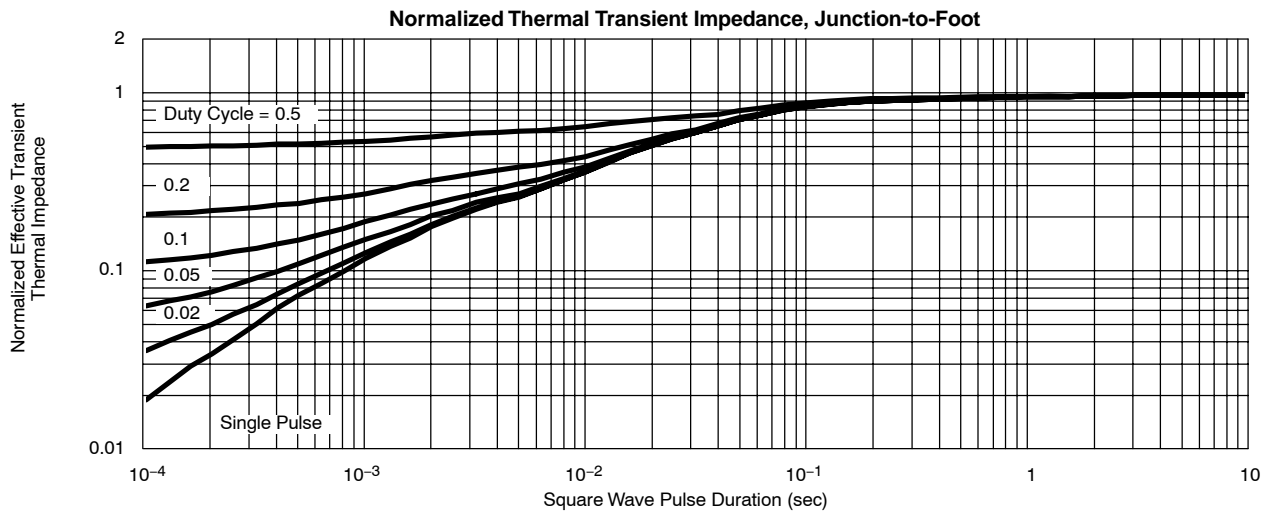
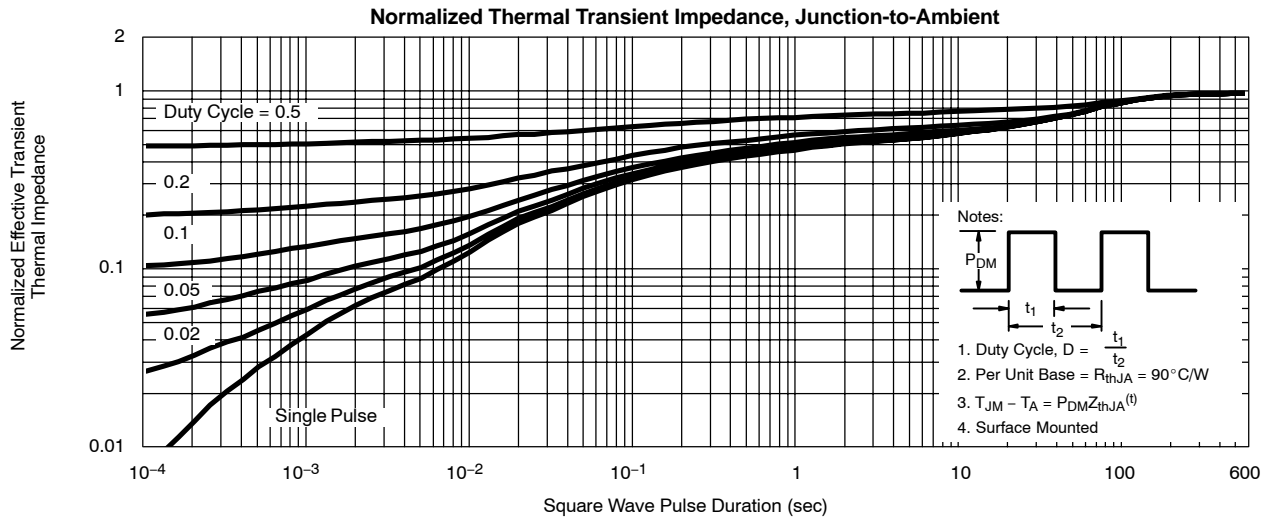

**TYPICAL CHARACTERISTICS (25°C UNLESS NOTED)**

**SCHOTTKY**

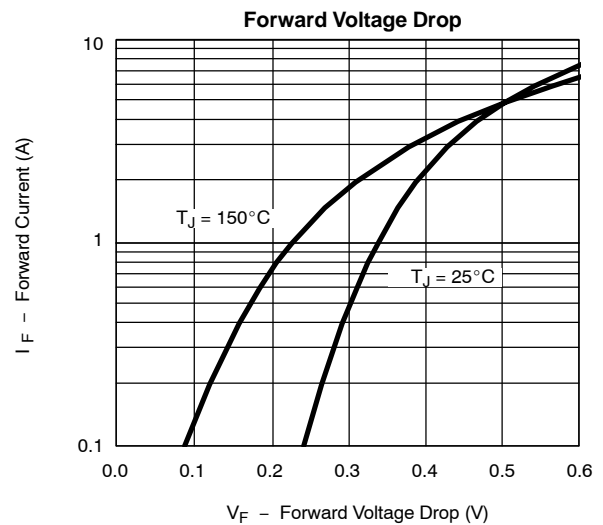
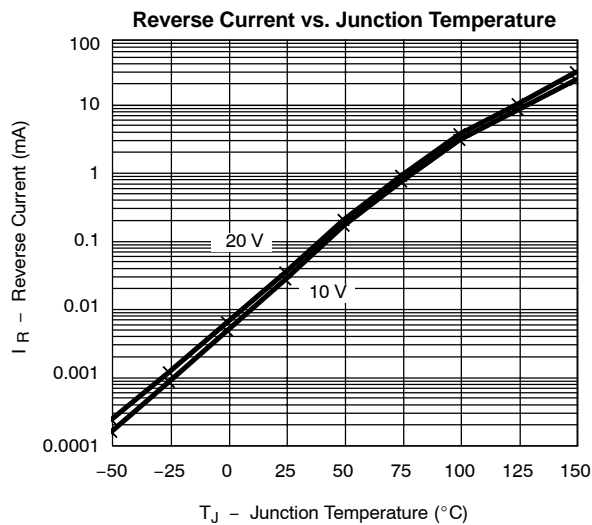

**TYPICAL CHARACTERISTICS (25 °C UNLESS NOTED)**

**SCHOTTKY**

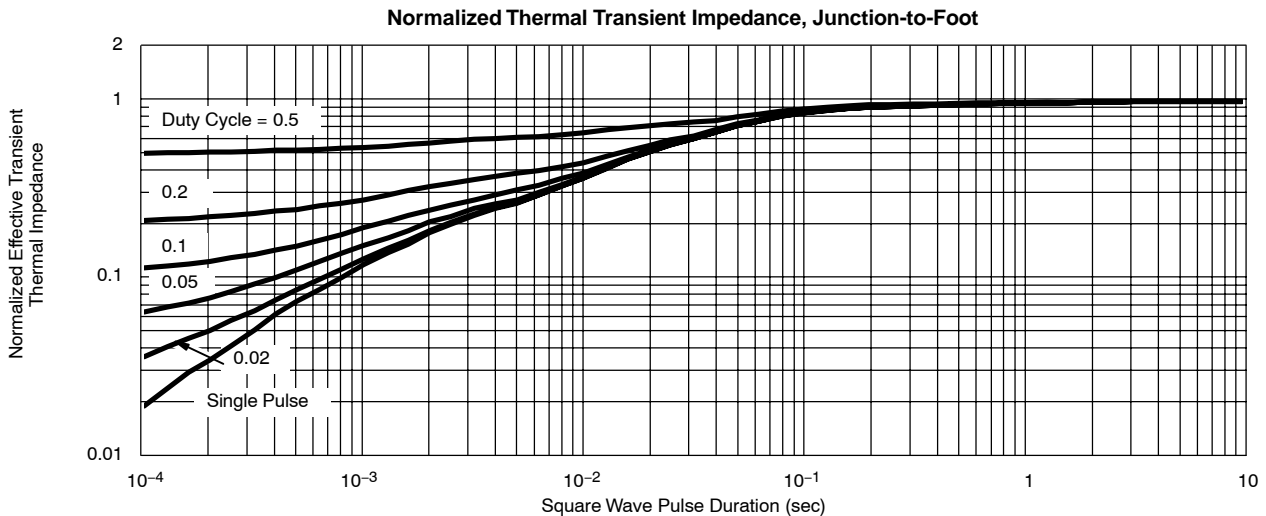
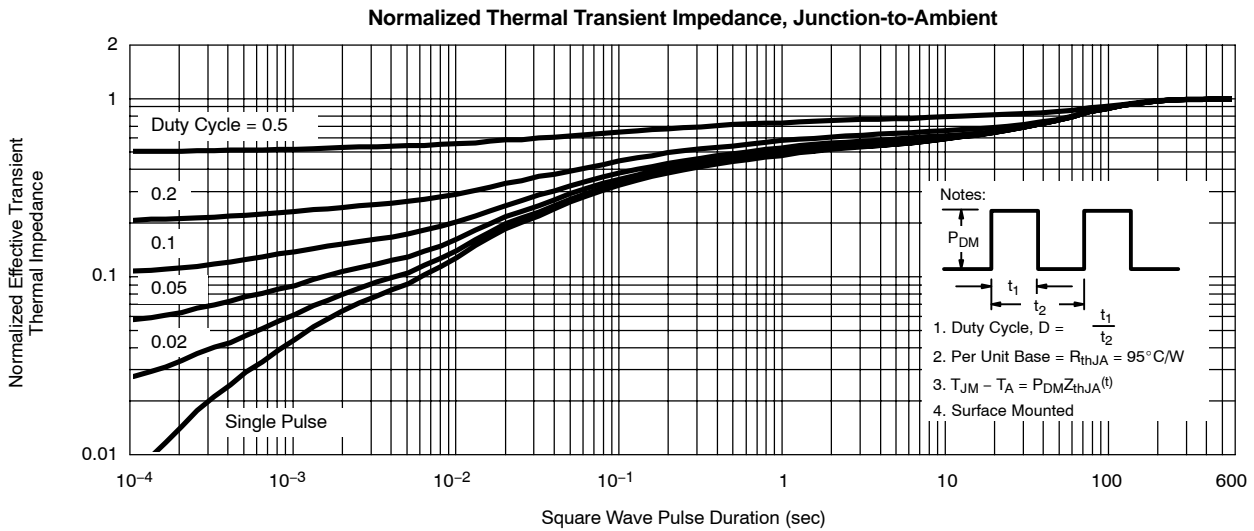
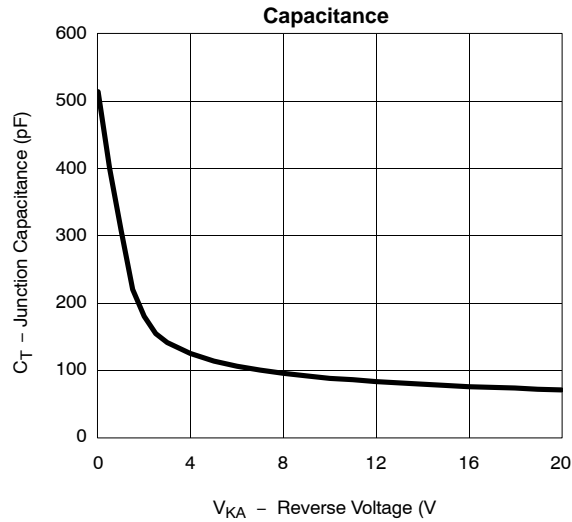



## Notice

Specifications of the products displayed herein are subject to change without notice. Vishay Intertechnology, Inc., or anyone on its behalf, assumes no responsibility or liability for any errors or inaccuracies.

Information contained herein is intended to provide a product description only. No license, express or implied, by estoppel or otherwise, to any intellectual property rights is granted by this document. Except as provided in Vishay's terms and conditions of sale for such products, Vishay assumes no liability whatsoever, and disclaims any express or implied warranty, relating to sale and/or use of Vishay products including liability or warranties relating to fitness for a particular purpose, merchantability, or infringement of any patent, copyright, or other intellectual property right.

The products shown herein are not designed for use in medical, life-saving, or life-sustaining applications. Customers using or selling these products for use in such applications do so at their own risk and agree to fully indemnify Vishay for any damages resulting from such improper use or sale.