

GaAs MMIC FUNDAMENTAL MIXER, 2.5 - 7.0 GHz

Typical Applications

The HMC557 is ideal for:

- WiMAX & Fixed Wireless
- Microwave Radio
- Military & Space
- Communications, Radar & EW
- Test Equipment & Sensors

Features

- High LO/Rf Isolation: 48 dB
- Wide IF Bandwidth: DC - 3 GHz
- Passive Double Balanced Topology
- Low Conversion Loss: 7 dB
- Small Size: 1.02 x 0.94 x 0.1 mm

Functional Diagram

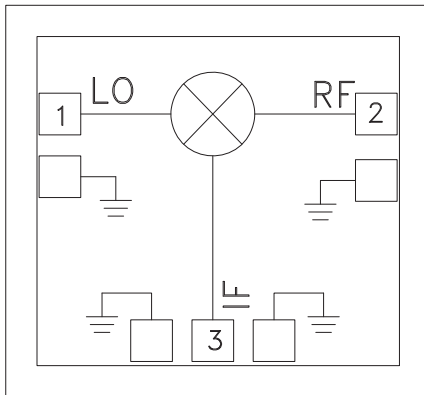

General Description

The HMC557 is a passive double balanced mixer that can be used as an upconverter or downconverter between 2.5 and 7 GHz. The miniature monolithic mixer is fabricated in a GaAs MESFET process, and requires no external components or matching circuitry. The HMC557 operates with LO drive levels as low as +9 dBm and provides excellent LO to RF and LO to IF isolation due to optimized balun structures. Measurements were made with the chip mounted into in a 50 ohm test fixture and includes the parasitic effects of wire bond assembly. Connections were made with a 1 mil wire bond with minimal length (<12 mil).

Electrical Specifications, $T_A = +25^\circ \text{C}$, $IF = 100 \text{ MHz}$, $LO = +15 \text{ dBm}^*$

Parameter	Min.	Typ.	Max.	Min.	Typ.	Max.	Units
Frequency Range, RF & LO	2.5 - 5.0			5.0 - 7.0			GHz
Frequency Range, IF	DC - 3			DC - 3			GHz
Conversion Loss		7	9.5		8	10.5	dB
Noise Figure (SSB)		7	9.5		8	10.5	dB
LO to RF Isolation	40	48		35	45		dB
LO to IF Isolation	25	30		22	28		dB
RF to IF Isolation	10	18		18	24		dB
IP3 (Input)		17			22		dBm
IP2 (Input)		50			50		dBm
1 dB Gain Compression (Input)		10			12		dBm

*Unless otherwise noted, all measurements performed as downconverter, $IF = 100 \text{ MHz}$.

**GaAs MMIC FUNDAMENTAL
MIXER, 2.5 - 7.0 GHz**

**Conversion Gain vs.
Temperature @ LO = +15 dBm**

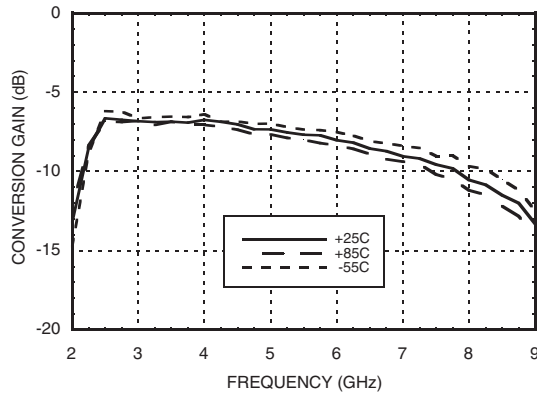

Isolation @ LO = +15 dBm

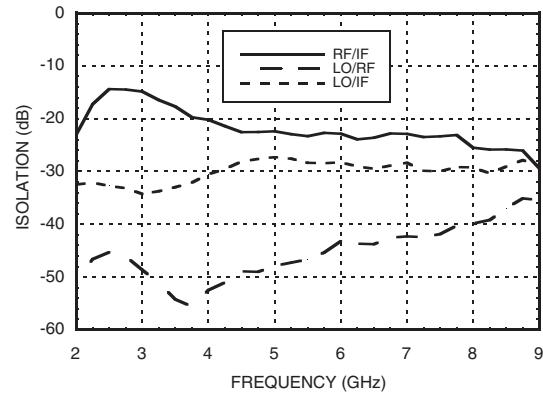

Conversion Gain vs. LO Drive

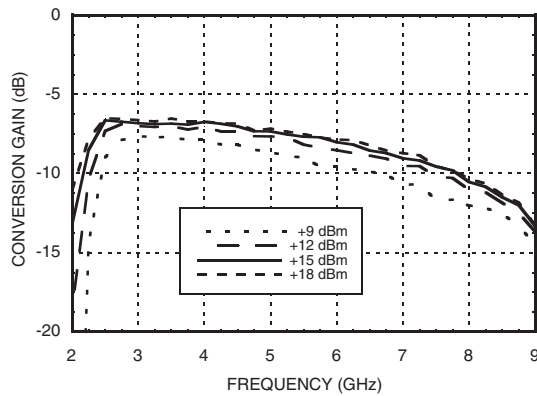

Return Loss @ LO = +15 dBm

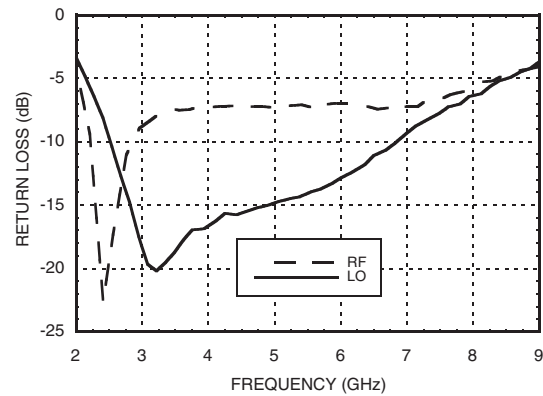

IF Bandwidth @ LO = +15 dBm

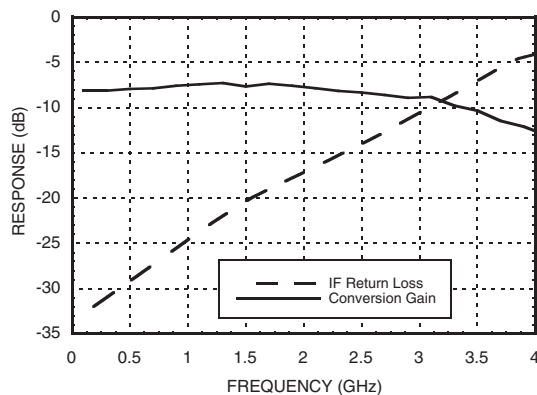

**Upconverter Performance
Conversion Gain vs. LO Drive**

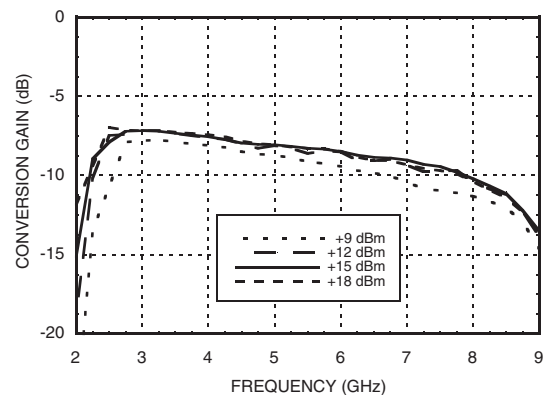

**GaAs MMIC FUNDAMENTAL
MIXER, 2.5 - 7.0 GHz**

Input IP3 vs. LO Drive *

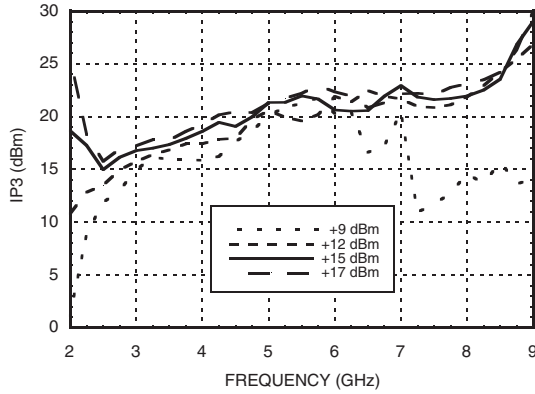

Input IP3 vs. Temperature @ LO = +15 dBm *

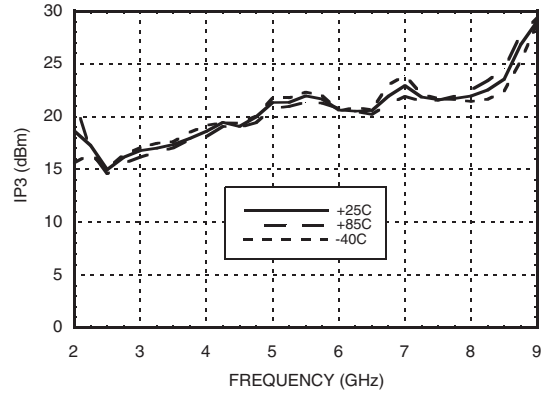

Input IP2 vs. LO Drive *

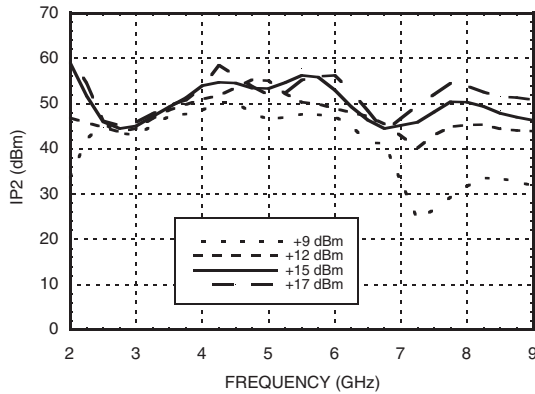

Input IP2 vs. Temperature @ LO = +15 dBm *

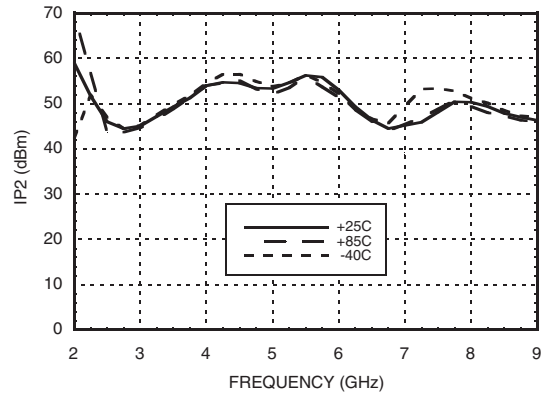

Input P1dB vs. Temperature @ LO = +15 dBm

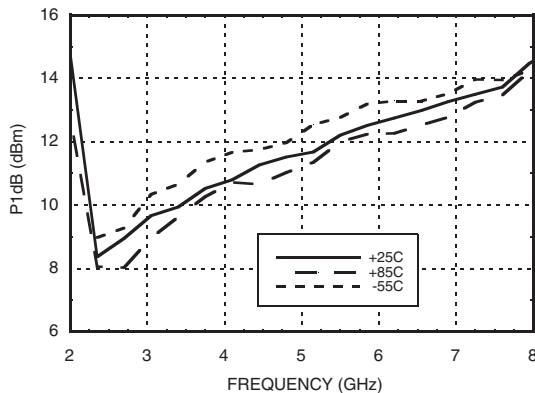

MxN Spurious Outputs

mRF	nLO				
	0	1	2	3	4
0	xx	-6	24	26	41
1	14	0	37	35	71
2	76	53	71	52	77
3	94	95	86	73	97
4	94	94	97	100	102

RF = 5.1 GHz @ -10 dBm
LO = 5 GHz @ +15 dBm
All values in dBc below the IF output power level.

* Two-tone input power = -10 dBm each tone, 1 MHz spacing.

**GaAs MMIC FUNDAMENTAL
MIXER, 2.5 - 7.0 GHz**

Absolute Maximum Ratings

RF / IF Input	+25 dBm
LO Drive	+25 dBm
Channel Temperature	150 °C
Continuous P _{diss} (T = 85 °C) (derate 7.6 mW/°C above 85 °C)	492 mW
Thermal Resistance (channel to die bottom)	132 °C/W
Storage Temperature	-65 to +150 °C
Operating Temperature	-55 to +85 °C



**ELECTROSTATIC SENSITIVE DEVICE
OBSERVE HANDLING PRECAUTIONS**

3

MIXERS - CHIP

Outline Drawing

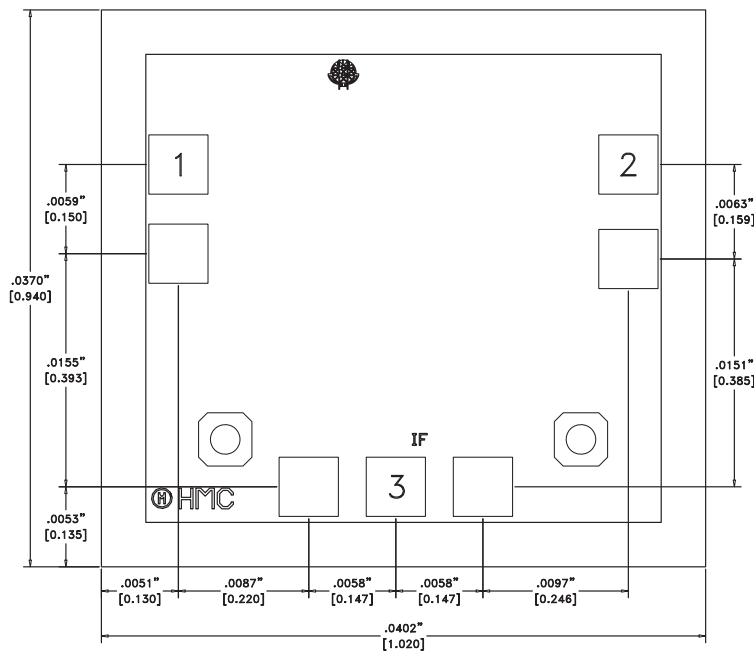

Die Packaging Information [1]

Standard	Alternate
WP-7	[2]

[1] Refer to the "Packaging Information" section for die packaging dimensions.



[2] For alternate packaging information contact Hittite Microwave Corporation.

NOTES:

1. ALL DIMENSIONS ARE IN INCHES [MM].
2. DIE THICKNESS IS .004".
3. TYPICAL BOND PAD IS .004" SQUARE.
4. BOND PAD SPACING CENTER TO CENTER IS .006".
5. BACKSIDE METALLIZATION: GOLD.
6. BOND PAD METALLIZATION: GOLD.
7. BACKSIDE METAL IS GROUND.
8. CONNECTION NOT REQUIRED FOR UNLABELED BOND PADS.
9. THIS DIE IS DESIGNED FOR PICK-UP WITH VACUUM (EDGE) COLLET TOOLS. TO PRECLUDE THE RISK OF PERMANENT DAMAGE, NO CONTACT TO THE DIE SURFACE IS ALLOWED WITHIN THIS RECTANGULAR AREA.

**GaAs MMIC FUNDAMENTAL
MIXER, 2.5 - 7.0 GHz**

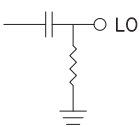
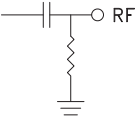
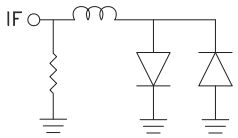
Pad Descriptions

Pad Number	Function	Description	Interface Schematic
1	LO	This pin is DC coupled and matched to 50 Ohms.	
2	RF	This pin is DC coupled and matched to 50 Ohms.	
3	IF	This pad is DC coupled. For applications not requiring operation to DC, this port should be DC blocked externally using a series capacitor whose value has been chosen to pass the necessary IF frequency range. For operation to DC, this pin must not source or sink more than 2 mA of current or part non-function and possible part failure will result.	
Die Bottom	GND	Die bottom must be connected to RF/DC ground.	

Assembly Drawing

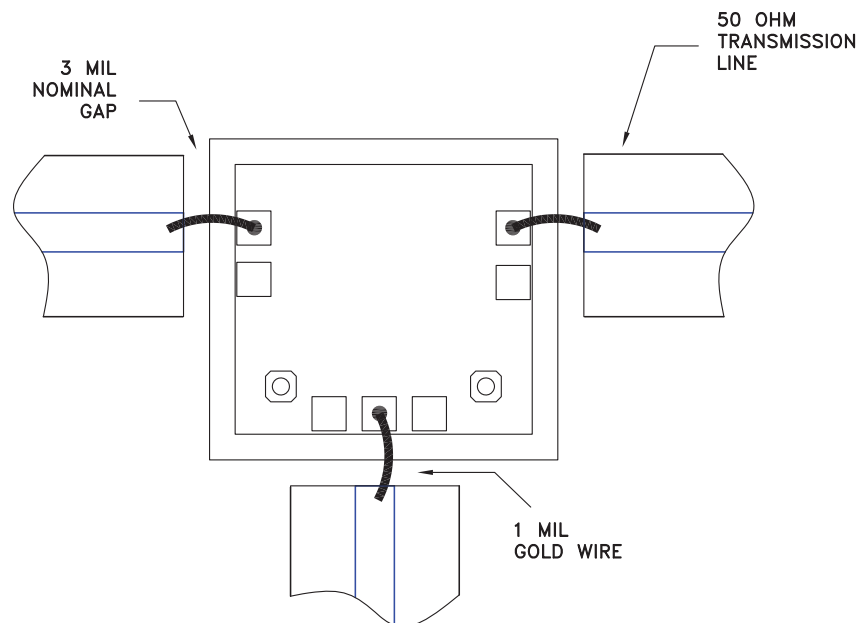

**GaAs MMIC FUNDAMENTAL
MIXER, 2.5 - 7.0 GHz**

Mounting & Bonding Techniques for Millimeterwave GaAs MMICs

The die should be attached directly to the ground plane eutectically or with conductive epoxy (see HMC general Handling, Mounting, Bonding Note).

50 Ohm Microstrip transmission lines on 0.127mm (5 mil) thick alumina thin film substrates are recommended for bringing RF to and from the chip (Figure 1). If 0.254mm (10 mil) thick alumina thin film substrates must be used, the die should be raised 0.150mm (6 mils) so that the surface of the die is coplanar with the surface of the substrate. One way to accomplish this is to attach the 0.102mm (4 mil) thick die to a 0.150mm (6 mil) thick molybdenum heat spreader (moly-tab) which is then attached to the ground plane (Figure 2).

Microstrip substrates should be brought as close to the die as possible in order to minimize ribbon bond length. Typical die-to-substrate spacing is 0.076mm (3 mils). Gold ribbon of 0.075 mm (3 mil) width and minimal length <0.31 mm (<12 mils) is recommended to minimize inductance on RF, LO & IF ports.

Handling Precautions

Follow these precautions to avoid permanent damage.

Storage: All bare die are placed in either Waffle or Gel based ESD protective containers, and then sealed in an ESD protective bag for shipment. Once the sealed ESD protective bag has been opened, all die should be stored in a dry nitrogen environment.

Cleanliness: Handle the chips in a clean environment. DO NOT attempt to clean the chip using liquid cleaning systems.

Static Sensitivity: Follow ESD precautions to protect against ESD strikes.

Transients: Suppress instrument and bias supply transients while bias is applied. Use shielded signal and bias cables to minimize inductive pick-up.

General Handling: Handle the chip along the edges with a vacuum collet or with a sharp pair of bent tweezers. The surface of the chip has fragile air bridges and should not be touched with vacuum collet, tweezers, or fingers.

Mounting

The chip is back-metallized and can be die mounted with AuSn eutectic preforms or with electrically conductive epoxy. The mounting surface should be clean and flat.

Eutectic Die Attach: A 80/20 gold tin preform is recommended with a work surface temperature of 255 °C and a tool temperature of 265 °C. When hot 90/10 nitrogen/hydrogen gas is applied, tool tip temperature should be 290 °C. DO NOT expose the chip to a temperature greater than 320 °C for more than 20 seconds. No more than 3 seconds of scrubbing should be required for attachment.

Epoxy Die Attach: Apply a minimum amount of epoxy to the mounting surface so that a thin epoxy fillet is observed around the perimeter of the chip once it is placed into position. Cure epoxy per the manufacturer's schedule.

Wire Bonding

Ball or wedge bond with 0.025 mm (1 mil) diameter pure gold wire is recommended. Thermosonic wirebonding with a nominal stage temperature of 150 °C and a ball bonding force of 40 to 50 grams or wedge bonding force of 18 to 22 grams is recommended. Use the minimum level of ultrasonic energy to achieve reliable wirebonds. Wirebonds should be started on the chip and terminated on the package or substrate. All bonds should be as short as possible <0.31 mm (12 mils).

