

## Single and Dual Single Supply Ultra-Low Noise, Low Distortion Rail-to-Rail Output, Op Amp

The ISL28191 and ISL28291 are tiny single and dual ultra-low noise, ultra-low distortion operational amplifiers. They are fully specified to operate down to +3V single supply. These amplifiers have outputs that swing rail-to-rail and an input common mode voltage that extends to ground (ground sensing).

The ISL28191 and ISL28291 are unity gain stable with an input referred voltage noise of 1.7nV/√Hz. Both parts feature 0.00018% THD+N at 1kHz.

The ISL28191 is available in the space-saving 6 Ld  $\mu$ TDFN (1.6mmx1.6mm) and 6 Ld SOT-23 packages. The ISL28291 is available in the 8 Ld SOIC, 10 Ld 1.8mmx1.4mm  $\mu$ TQFN and 10 Ld MSOP packages. All devices are guaranteed over -40°C to +125°C.

### Ordering Information

PART NUMBER	PART MARKING	PACKAGE (Pb-free)	PKG. DWG. #
ISL28191FHZ-T7* (Note 1)	GABJ	6 Ld SOT-23	MDP0038
<i>Coming Soon</i> ISL28191FRUZ (Note 2)	M8	6 Ld $\mu$ TDFN	L6.1.6x1.6A
<i>Coming Soon</i> ISL28191FRUZ-T7* (Note 2)	M8	6 Ld $\mu$ TDFN	L6.1.6x1.6A
ISL28291FUZ (Note 1)	8291Z	10 Ld MSOP	MDP0043
ISL28291FUZ-T7* (Note 1)	8291Z	10 Ld MSOP	MDP0043
<i>Coming Soon</i> ISL28291FBZ (Note 1)	28291 FBZ	8 Ld SOIC	MDP0027
<i>Coming Soon</i> ISL28291FBZ-T7 (Note 1)	28291 FBZ	8 Ld SOIC	MDP0027
<i>Coming Soon</i> ISL28291FRUZ-T7* (Note 2)	F	10 Ld $\mu$ TQFN	L10.1.8x1.4A

\*Please refer to TB347 for details on reel specifications.

#### NOTES:

- These Intersil Pb-free plastic packaged products employ special Pb-free material sets; molding compounds/die attach materials and 100% matte tin plate PLUS ANNEAL - e3 termination finish, which is RoHS compliant and compatible with both SnPb and Pb-free soldering operations. Intersil Pb-free products are MSL classified at Pb-free peak reflow temperatures that meet or exceed the Pb-free requirements of IPC/JEDEC J STD-020.
- These Intersil Pb-free plastic packaged products employ special Pb-free material sets; molding compounds/die attach materials and NiPdAu plate - e4 termination finish, which is RoHS compliant and compatible with both SnPb and Pb-free soldering operations. Intersil Pb-free products are MSL classified at Pb-free peak reflow temperatures that meet or exceed the Pb-free requirements of IPC/JEDEC J STD-020.

### Features

- 1.7nV/√Hz input voltage noise at 1kHz
- 1kHz THD+N typical 0.00018% at 2V<sub>P-P</sub> V<sub>OUT</sub>
- Harmonic Distortion -76dBc, -70dBc, f<sub>o</sub> = 1MHz
- 61MHz -3dB bandwidth
- 630 $\mu$ V maximum offset voltage
- 3 $\mu$ A input bias current
- 100dB typical CMRR
- 3V to 5.5V single supply voltage range
- Rail-to-rail output
- Ground Sensing
- Enable pin (not available in the 8 Ld SOIC package option)
- Pb-free (RoHS compliant)

### Applications

- Low noise signal processing
- Low noise microphones/preamplifiers
- ADC buffers
- DAC output amplifiers
- Digital scales
- Strain gauges/sensor amplifiers
- Radio systems
- Portable equipment
- Infrared detectors

Pinouts

ISL28191  
(6 LD SOT-23)  
TOP VIEW

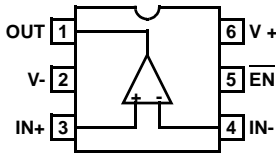

ISL28191  
(6 LD 1.6X1.6X0.5 μTDFN)  
TOP VIEW

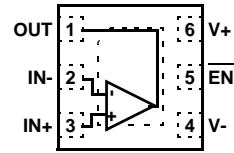

ISL28291  
(8 LD SOIC)  
TOP VIEW

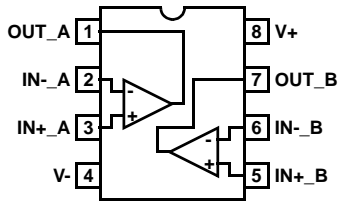

ISL28291  
(10 LD MSOP)  
TOP VIEW

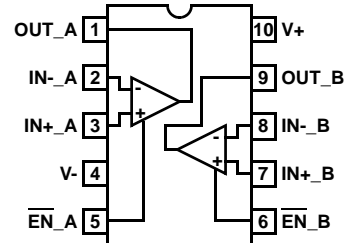

ISL28291  
(10 LD μTQFN)  
TOP VIEW

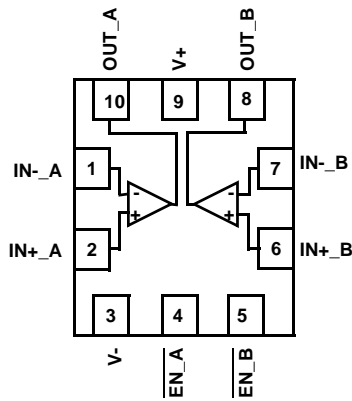

**Absolute Maximum Ratings** ( $T_A = +25^\circ\text{C}$ )

Supply Voltage	5.5V
Supply Turn On Voltage Slew Rate	1V/ $\mu\text{s}$
Differential Input Current	5mA
Differential Input Voltage	0.5V
Input Voltage	V- - 0.5V to V+ + 0.5V
ESD Tolerance	
Human Body Model	.3kV
Machine Model	.300V

**Thermal Information**

Thermal Resistance	$\theta_{JA}$ ( $^\circ\text{C}/\text{W}$ )
6 Ld SOT-23 Package	230
6 Ld $\mu\text{TDFN}$ Package	120
8 Ld SO Package	110
10 Ld MSOP Package	115
6 Ld $\mu\text{TQFN}$ Package	143
Ambient Operating Temperature Range	-40 $^\circ\text{C}$ to +125 $^\circ\text{C}$
Storage Temperature Range	-65 $^\circ\text{C}$ to +150 $^\circ\text{C}$
Operating Junction Temperature	+125 $^\circ\text{C}$
Pb-free reflow profile	see link below
	<a href="http://www.intersil.com/pbfree/Pb-FreeReflow.asp">http://www.intersil.com/pbfree/Pb-FreeReflow.asp</a>

*CAUTION: Do not operate at or near the maximum ratings listed for extended periods of time. Exposure to such conditions may adversely impact product reliability and result in failures not covered by warranty.*

*IMPORTANT NOTE: All parameters having Min/Max specifications are guaranteed. Typical values are for information purposes only. Unless otherwise noted, all tests are at the specified temperature and are pulsed tests, therefore:  $T_J = T_C = T_A$*

**Electrical Specifications**  $V_+ = 5.0\text{V}$ ,  $V_- = \text{GND}$ ,  $R_L = \text{Open}$ ,  $R_F = 1\text{k}\Omega$ ,  $A_V = -1$  unless otherwise specified. Parameters are per amplifier. Typical values are at  $V_+ = 5\text{V}$ ,  $T_A = +25^\circ\text{C}$ . **Boldface limits apply over the operating temperature range, -40 $^\circ\text{C}$  to +125 $^\circ\text{C}$ , temperature data guaranteed by characterization.**

PARAMETER	DESCRIPTION	CONDITIONS	MIN (Note 3)	TYP	MAX (Note 3)	UNIT
<b>DC SPECIFICATIONS</b>						
$V_{OS}$	Input Offset Voltage			270	630 <b>840</b>	$\mu\text{V}$
$\frac{\Delta V_{OS}}{\Delta T}$	Input Offset Drift vs Temperature	Figure 21		3.1		$\mu\text{V}/^\circ\text{C}$
$I_{IO}$	Input Offset Current			35	500 <b>900</b>	nA
$I_B$	Input Bias Current			3	6 <b>7</b>	$\mu\text{A}$
CMIR	Common-Mode Input Range		0		3.8	V
CMRR	Common-Mode Rejection Ratio	$V_{CM} = 0\text{V}$ to 3.8V	78	100		dB
PSRR	Power Supply Rejection Ratio	$V_S = 3\text{V}$ to 5V	74	80		dB
$A_{VOL}$	Large Signal Voltage Gain	$V_O = 0.5\text{V}$ to 4V, $R_L = 1\text{k}\Omega$	90 <b>86</b>	98		dB
$V_{OUT}$	Maximum Output Voltage Swing	Output low, $R_L = 1\text{k}\Omega$		20	50 <b>80</b>	mV
		Output high, $R_L = 1\text{k}\Omega$ , $V_+ = 5\text{V}$	4.95 <b>4.92</b>	4.97		V
$I_{S,ON}$	Supply Current, Enabled			2.6	3.5 <b>3.9</b>	mA
$I_{S,OFF}$	Supply Current, Disabled			26	35 <b>48</b>	$\mu\text{A}$
$I_{O+}$	Short-Circuit Output Current	$R_L = 10\Omega$	95 <b>90</b>	130		mA
$I_{O-}$	Short-Circuit Output Current	$R_L = 10\Omega$	95 <b>90</b>	130		mA
$V_{SUPPLY}$	Supply Operating Range	V+ to V-	3		5.5	V
$\overline{V_{ENH}}$	$\overline{EN}$ High Level	Referred to V-	2			V
$\overline{V_{ENL}}$	$\overline{EN}$ Low Level	Referred to V-			0.8	V

# ISL28191, ISL28291

**Electrical Specifications**  $V_+ = 5.0V$ ,  $V_- = GND$ ,  $R_L = \text{Open}$ ,  $R_F = 1k\Omega$ ,  $A_V = -1$  unless otherwise specified. Parameters are per amplifier. Typical values are at  $V_+ = 5V$ ,  $T_A = +25^\circ C$ . **Boldface limits apply over the operating temperature range,  $-40^\circ C$  to  $+125^\circ C$ , temperature data guaranteed by characterization. (Continued)**

PARAMETER	DESCRIPTION	CONDITIONS	MIN (Note 3)	TYP	MAX (Note 3)	UNIT
$I_{\overline{EN}H}$	$\overline{EN}$ Pin Input High Current	$V_{\overline{EN}} = V_+$		0.8	1.1 <b>1.3</b>	$\mu A$
$I_{\overline{EN}L}$	$\overline{EN}$ Pin Input Low Current	$V_{\overline{EN}} = V_-$		20	80 <b>100</b>	nA
<b>AC SPECIFICATIONS</b>						
GBW	-3dB Unity Gain Bandwidth	$R_F = 0\Omega$ , $C_L = 20pF$ , $A_V = 1$ , $R_L = 10k\Omega$		61		MHz
THD+N	Total Harmonic Distortion + Noise	$f = 1kHz$ , $V_{OUT} + 2V_{P-P}$ , $A_V = +1$ , $R_L = 10k\Omega$		0.00018		%
HD (1MHz)	2nd Harmonic Distortion	$2V_{P-P}$ output voltage, $A_V = 1$		-76		dBc
	3rd Harmonic Distortion			-70		dBc
ISO	Off-state Isolation $f_O = 100kHz$	$A_V = +1$ , $V_{IN} = 100mV_{P-P}$ , $R_F = 0\Omega$ $C_L = 20pF$ , $A_V = 1$ , $R_L = 10k\Omega$		-38		dB
X-TALK ISL28291	Channel to Channel Crosstalk $f_O = 100kHz$	$V_S = \pm 2.5V$ , $A_V = +1$ , $V_{IN} = 1V_{P-P}$ , $R_F = 0\Omega$ , $C_L = 20pF$ , $A_V = 1$ , $R_L = 10k\Omega$		-105		dB
PSRR	Power Supply Rejection Ratio $f_O = 100kHz$	$V_S = \pm 2.5V$ , $A_V = +1$ , $V_{SOURCE} = 1V_{P-P}$ , $R_F = 0\Omega$ , $C_L = 20pF$ , $A_V = 1$ , $R_L = 10k\Omega$		-70		dB
CMRR	Common Mode Rejection Ratio $f_O = 100kHz$	$V_S = \pm 2.5V$ , $A_V = +1$ , $V_{CM} = 1V_{P-P}$ , $R_F = 0\Omega$ , $C_L = 20pF$ , $A_V = 1$ , $R_L = 10k\Omega$		-65		dB
$e_n$	Input Referred Voltage Noise	$f_O = 1kHz$		1.7		$nV/\sqrt{Hz}$
$i_n$	Input Referred Current Noise	$f_O = 1kHz$		1.8		$pA/\sqrt{Hz}$
<b>TRANSIENT RESPONSE</b>						
SR	Slew Rate		<b>12</b> <b>12</b>	17		$V/\mu s$
$t_r$ , $t_f$ , Small Signal	Rise Time, $t_r$ 10% to 90%	$A_V = 1$ , $V_{OUT} = 0.1V_{P-P}$ , $R_L = 10k\Omega$ , $C_L = 1.2pF$		7		ns
	Fall Time, $t_f$ 90% to 10%			12		ns
$t_r$ , $t_f$ Large Signal	Rise Time, $t_r$ 10% to 90%	$A_V = 2$ , $V_{OUT} = 1V_{P-P}$ ; $R_L = 10k\Omega$ , $R_F/R_G = 499\Omega/499\Omega$ , $C_L = 1.2pF$		44		ns
	Fall Time, $t_f$ 90% to 10%			50		ns
	Rise Time, $t_r$ 10% to 90%	$A_V = 2$ , $V_{OUT} = 4.7V_{P-P}$ ; $R_L = 10k\Omega$ , $R_F/R_G = 499\Omega/499\Omega$ , $C_L = 1.2pF$		190		ns
	Fall Time, $t_f$ 90% to 10%			190		ns
$t_{\overline{EN}}$	ENABLE to Output Turn-on Delay Time; 10% $\overline{EN}$ - 10% $V_{OUT}$	$A_V = 1$ , $V_{OUT} = 1VDC$ , $R_L = 10k\Omega$ , $C_L = 1.2pF$		330		ns
	ENABLE to Output Turn-off Delay Time; 10% $\overline{EN}$ - 10% $V_{OUT}$	$A_V = 1$ , $V_{OUT} = 0VDC$ , $R_L = 10k\Omega$ , $C_L = 1.2pF$		50		ns

NOTE:

- Parts are 100% tested at  $+25^\circ C$ . Temperature limits established by characterization and are not production tested.

Typical Performance Curves

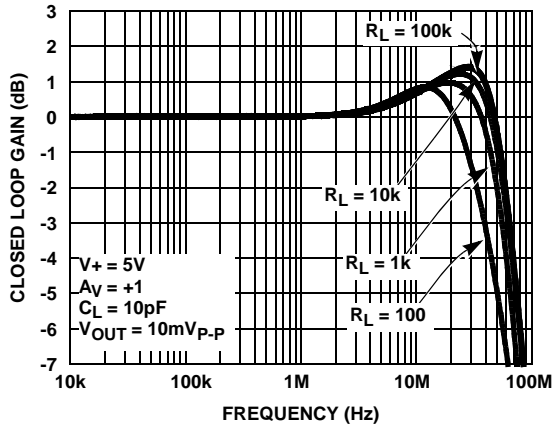

FIGURE 1. GAIN vs FREQUENCY FOR VARIOUS  $R_{LOAD}$

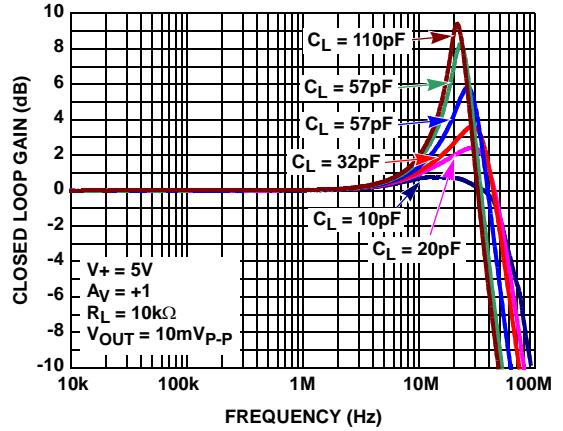

FIGURE 2. GAIN vs FREQUENCY FOR VARIOUS  $C_{LOAD}$

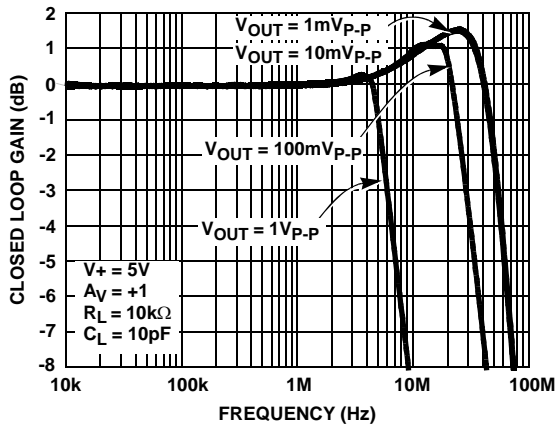

FIGURE 3. -3dB BANDWIDTH vs  $V_{OUT}$

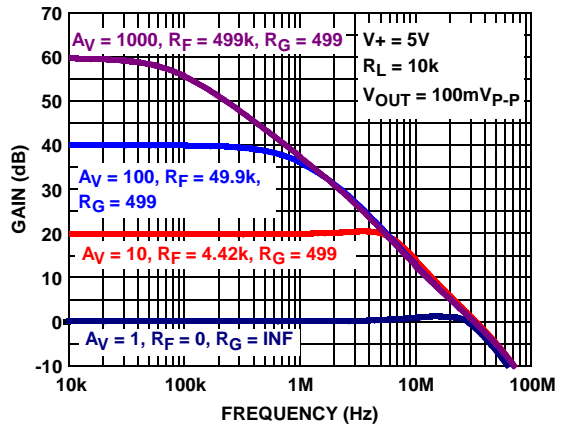

FIGURE 4. FREQUENCY RESPONSE vs CLOSED LOOP GAIN

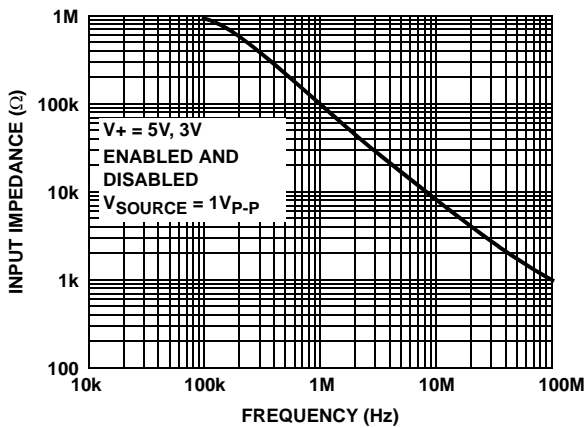

FIGURE 5. INPUT IMPEDANCE vs FREQUENCY

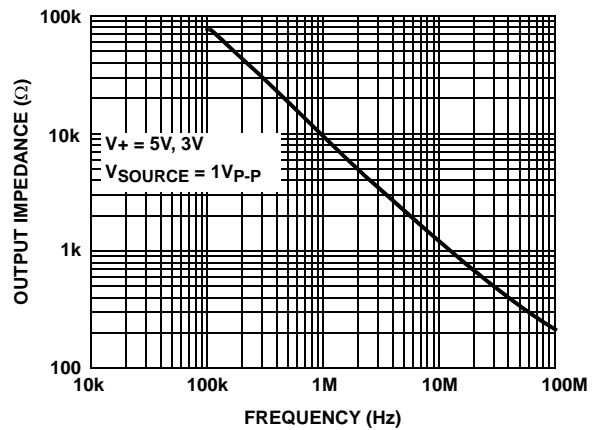

FIGURE 6. DISABLED OUTPUT IMPEDANCE vs FREQUENCY

Typical Performance Curves (Continued)

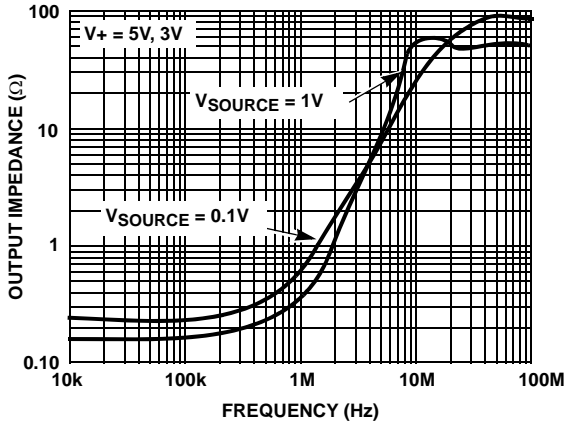

FIGURE 7. ENABLED OUTPUT IMPEDANCE vs FREQUENCY

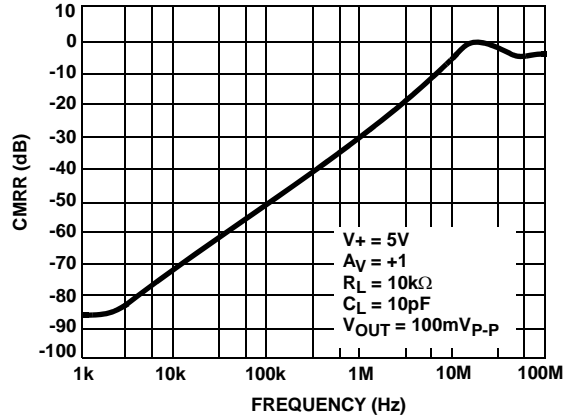

FIGURE 8. CMRR vs FREQUENCY

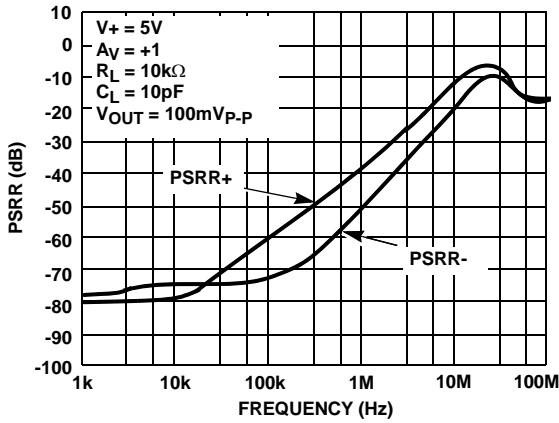

FIGURE 9. PSRR vs FREQUENCY

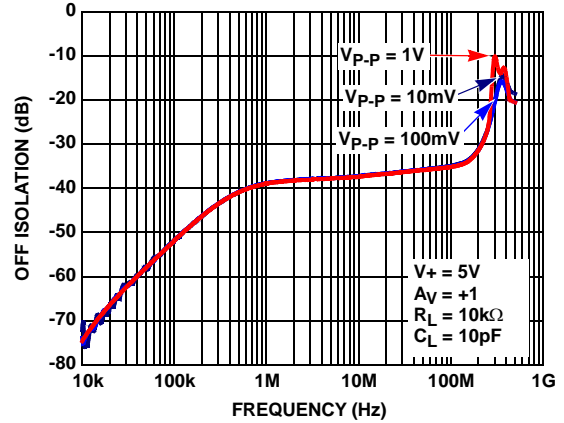

FIGURE 10. OFF ISOLATION vs FREQUENCY

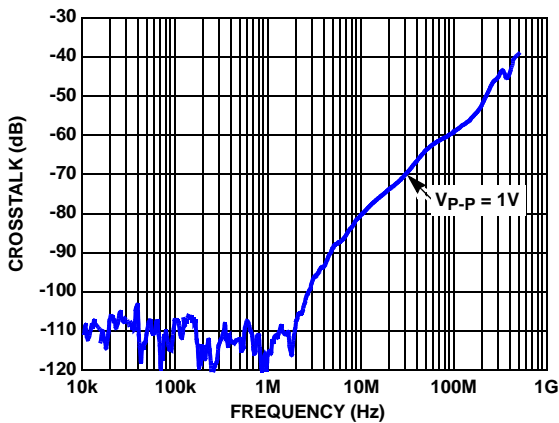

FIGURE 11. CHANNEL TO CHANNEL CROSSTALK vs FREQUENCY

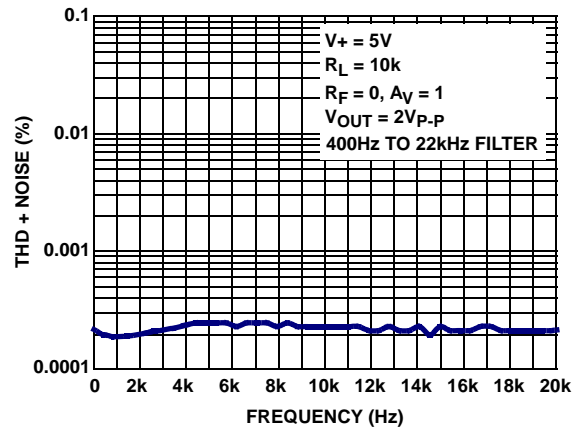

FIGURE 12. THD+N vs FREQUENCY

Typical Performance Curves (Continued)

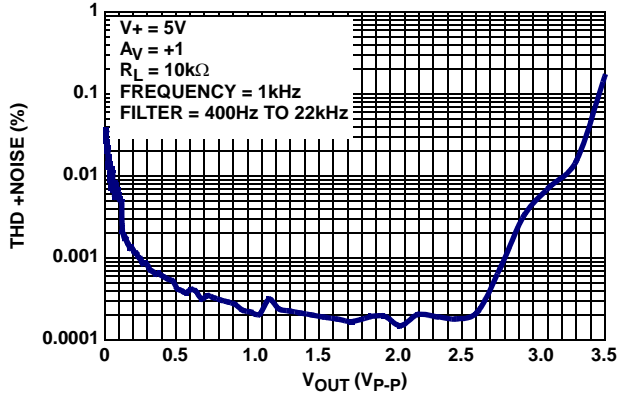

FIGURE 13. THD+N @ 1kHz vs  $V_{OUT}$

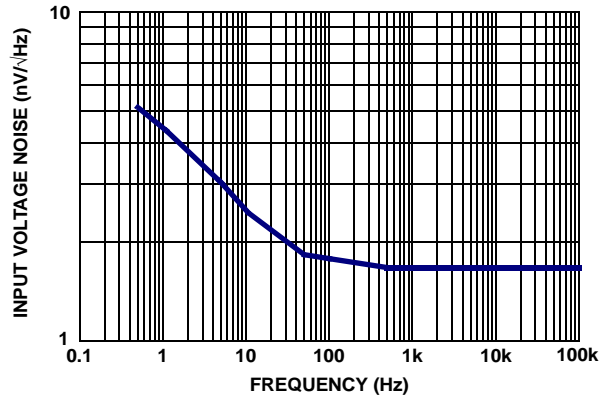

FIGURE 14. INPUT REFERRED NOISE VOLTAGE vs FREQUENCY

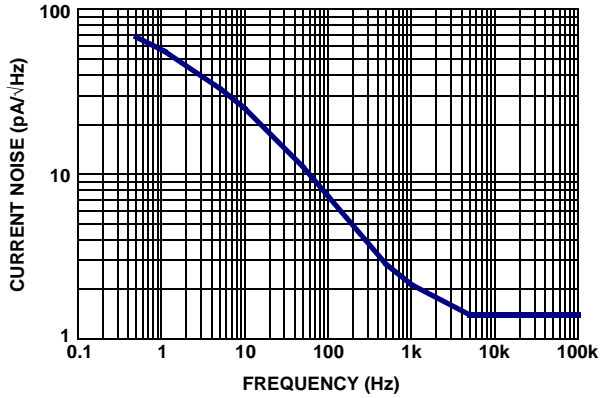

FIGURE 15. INPUT REFERRED NOISE CURRENT vs FREQUENCY

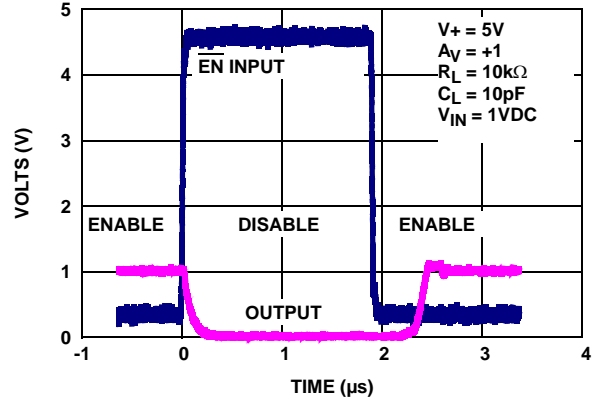

FIGURE 16. ENABLE/DISABLE TIMING

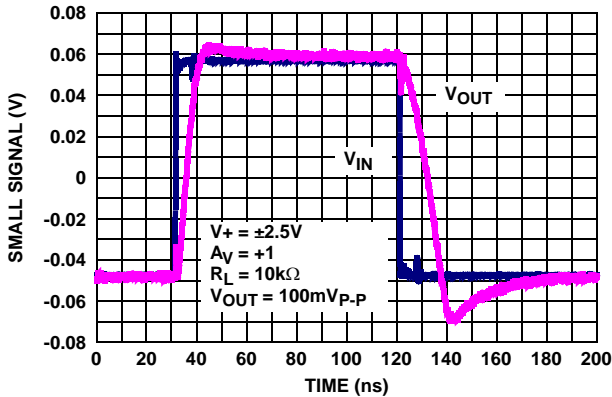

FIGURE 17. SMALL SIGNAL STEP RESPONSE

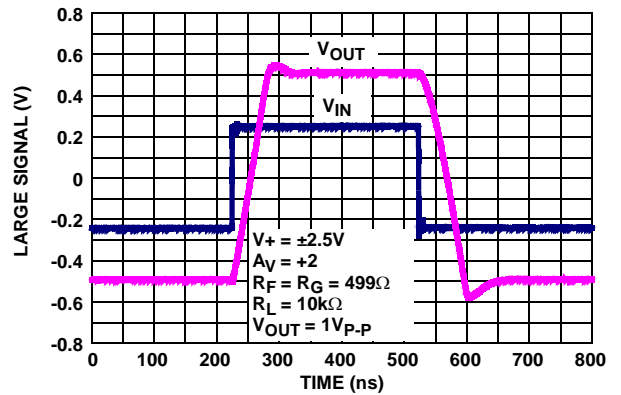

FIGURE 18. LARGE SIGNAL (1V) STEP RESPONSE

Typical Performance Curves (Continued)

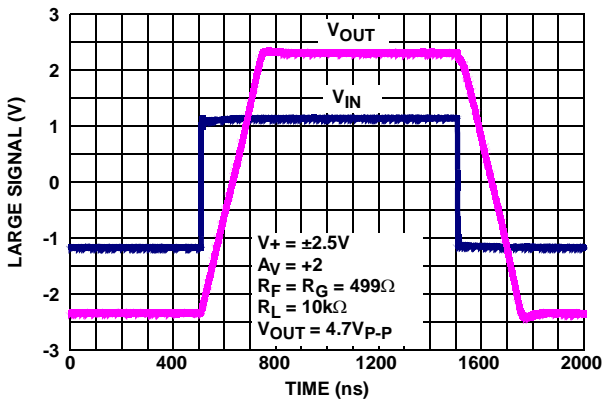

FIGURE 19. LARGE SIGNAL (4.7V) STEP RESPONSE

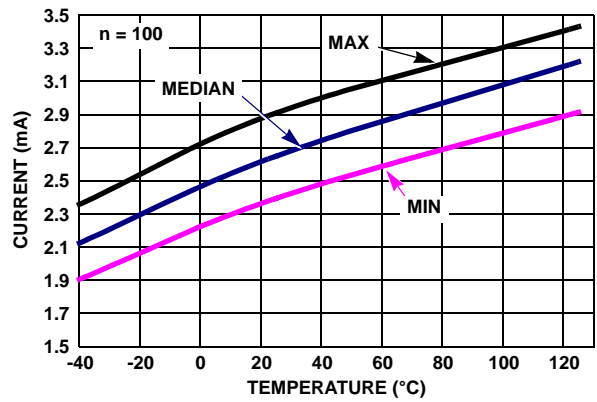

FIGURE 20. SUPPLY CURRENT vs TEMPERATURE,  $V_S = \pm 2.5V$  ENABLED,  $R_L = \text{INF}$

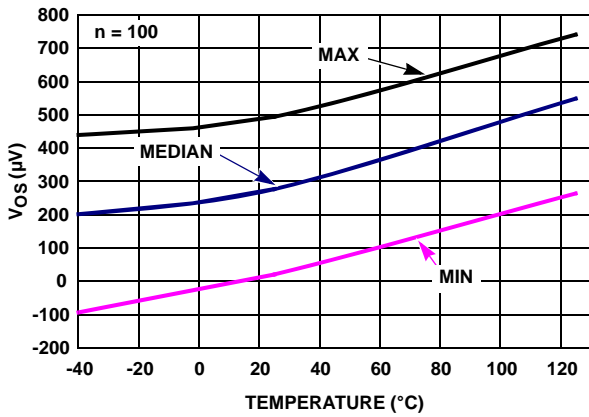

FIGURE 21.  $V_{OS}$  vs TEMPERATURE,  $V_S = \pm 2.5V$

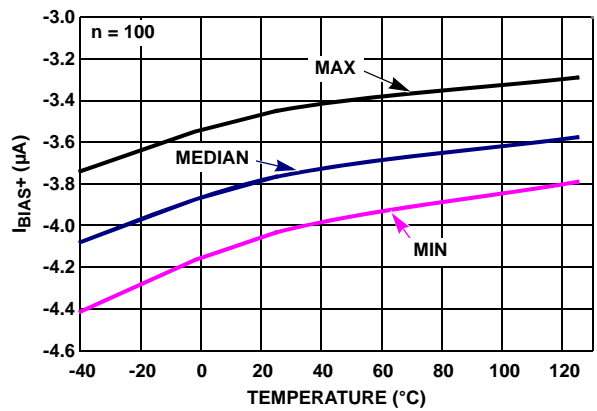

FIGURE 22.  $I_{BIAS+}$  vs TEMPERATURE,  $V_S = \pm 2.5V$

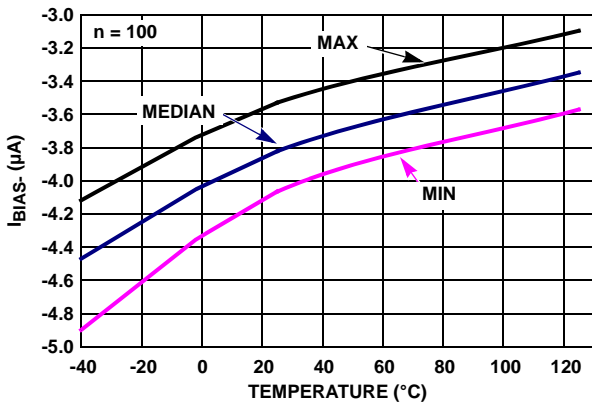

FIGURE 23.  $I_{BIAS-}$  vs TEMPERATURE,  $V_S = \pm 2.5V$

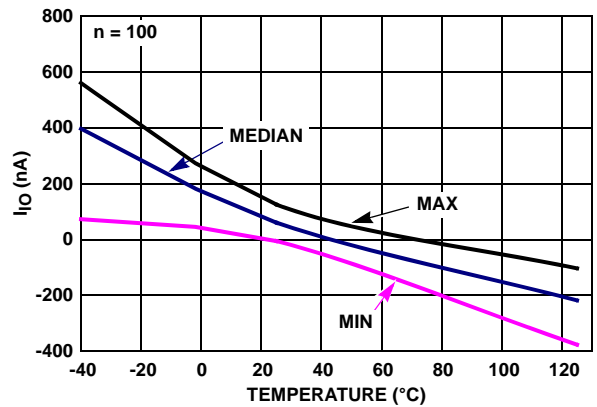

FIGURE 24.  $I_{IO}$  vs TEMPERATURE,  $V_S = \pm 2.5V$



Typical Performance Curves (Continued)

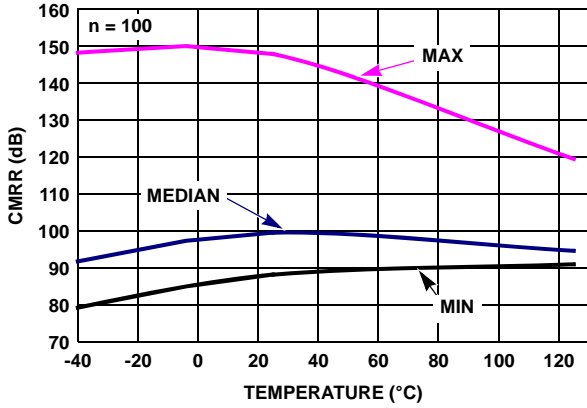

FIGURE 25. CMRR vs TEMPERATURE, VCM = 3.8V, VS = ±2.5V

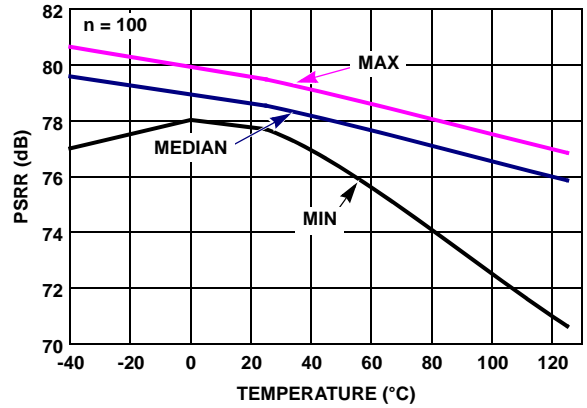

FIGURE 26. PSRR vs TEMPERATURE ±1.5V TO ±2.5V

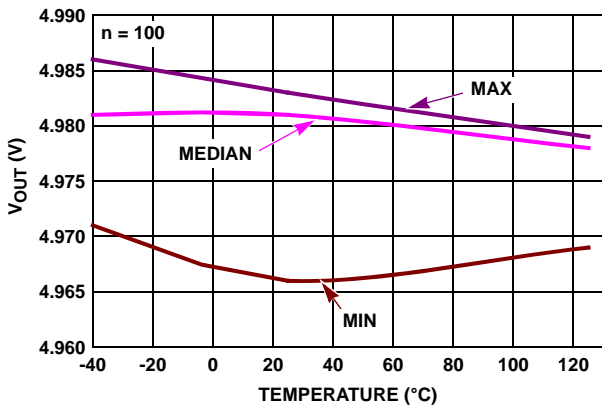

FIGURE 27. POSITIVE VOUT vs TEMPERATURE, RL = 1k VS = ±2.5V

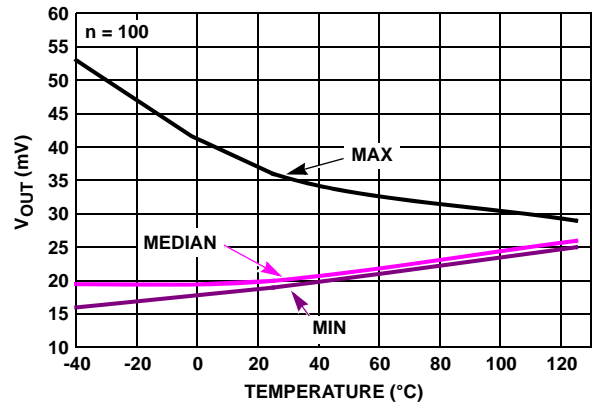
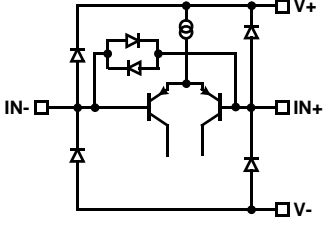
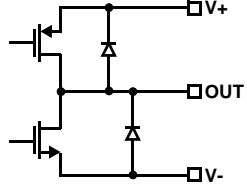
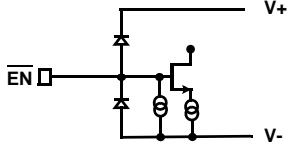

FIGURE 28. NEGATIVE VOUT vs TEMPERATURE, RL = 1k VS = ±2.5V

Pin Descriptions

ISL28191 (6 Ld SOT-23)	ISL28191 (6 Ld μTDFN)	ISL28291 (8 Ld SOIC)	ISL28291 (10 Ld MSOP)	ISL28291 (10 Ld μTQFN)	PIN NAME	FUNCTION	EQUIVALENT CIRCUIT
4	2	2 (A) 6 (B)	2 (A) 8 (B)	1 (A) 7 (B)	IN- IN-_A IN-_B	Inverting input	
3	3	3 (A) 5 (B)	3 (A) 7 (B)	2 (A) 6 (B)	IN+ IN+_B IN+_B	Non-inverting input	(See circuit 1)
2	4	4	4	3	V-	Negative supply	

**Pin Descriptions** (Continued)

ISL28191 (6 Ld SOT-23)	ISL28191 (6 Ld $\mu$ TFDN)	ISL28291 (8 Ld SOIC)	ISL28291 (10 Ld MSOP)	ISL28291 (10 Ld $\mu$ TQFN)	PIN NAME	FUNCTION	EQUIVALENT CIRCUIT
1	1	1 (A) 7 (B)	1 (A) 9 (B)	10 (A) 8 (B)	OUT OUT_A OUT_B	Output	 Circuit 2
6	6	8	10	9	V+	Positive supply	
5	5	N/A	5 (A) 6 (B)	4 (A) 5 (B)	$\overline{\text{EN}}$ $\overline{\text{EN}}_A$ $\overline{\text{EN}}_B$	Enable BAR pin internal pull-down; Logic "1" selects the disabled state; Logic "0" selects the enabled state.	 Circuit 3

**Applications Information**

**Product Description**

The ISL28191 and ISL28291 are voltage feedback operational amplifiers designed for communication and imaging applications requiring low distortion, very low voltage and current noise. Both parts feature high bandwidth while drawing moderately low supply current. They use a classical voltage-feedback topology, which allows them to be used in a variety of applications where current-feedback amplifiers are not appropriate because of restrictions placed upon the feedback element used with the amplifier.

**Enable/Power-Down**

The ISL28191 and ISL28291 amplifiers are disabled by applying a voltage greater than 2V to the  $\overline{\text{EN}}$  pin, with respect to the V- pin. In this condition, the output(s) will be in a high impedance state and the amplifier(s) current will be reduced to 13 $\mu$ A/Amp. By disabling the part, multiple parts can be connected together as a MUX. The outputs are tied together in parallel and a channel can be selected by the  $\overline{\text{EN}}$  pin. The  $\overline{\text{EN}}$  pin also has an internal pull-down. If left open, the  $\overline{\text{EN}}$  pin will pull to the negative rail and the device will be enabled by default.

**Input Protection**

All input terminals have internal ESD protection diodes to both positive and negative supply rails, limiting the input voltage to within one diode beyond the supply rails. Both parts have additional back-to-back diodes across the input terminals (as shown in Figure 29). In pulse applications where the input Slew Rate exceeds the Slew Rate of the amplifier, the possibility exists for the input protection diodes to become forward biased. This can cause excessive input current and distortion at the outputs. If overdriving the inputs is necessary, the external input current must never exceed 5mA. An

external series resistor may be used to limit the current, as shown in Figure 29.

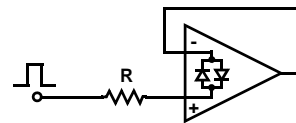

FIGURE 29. LIMITING THE INPUT CURRENT TO LESS THAN 5mA

**Using Only One Channel**

The ISL28291 is a dual channel op amp. If the application only requires one channel when using the ISL28291, the user must configure the unused channel to prevent it from oscillating. Oscillation can occur if the input and output pins are floating. This will result in higher than expected supply currents and possible noise injection into the channel being used. The proper way to prevent this oscillation is to short the output to the negative input and ground the positive input (as shown in Figure 30).

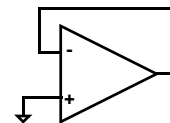

FIGURE 30. PREVENTING OSCILLATIONS IN UNUSED CHANNELS

**Power Supply Bypassing and Printed Circuit Board Layout**

As with any high frequency device, good printed circuit board layout is necessary for optimum performance. Low impedance ground plane construction is essential. Surface mount components are recommended, but if leaded components are used, lead lengths should be as short as possible. The power supply pins must be well bypassed to

reduce the risk of oscillation. The combination of a 4.7µF tantalum capacitor in parallel with a 0.01µF capacitor has been shown to work well when placed at each supply pin.

For good AC performance, parasitic capacitance should be kept to a minimum, especially at the inverting input. When ground plane construction is used, it should be removed from the area near the inverting input to minimize any stray capacitance at that node. Carbon or Metal-Film resistors are acceptable with the Metal-Film resistors giving slightly less peaking and bandwidth because of additional series inductance. Use of sockets, particularly for the SOIC package, should be avoided if possible. Sockets add parasitic inductance and capacitance, which will result in additional peaking and overshoot.

**Current Limiting**

The ISL28191 and ISL28291 have no internal current-limiting circuitry. If the output is shorted, it is possible to exceed the Absolute Maximum Rating for output current or power dissipation, potentially resulting in the destruction of the device. This is why the output short circuit current is specified and tested with  $R_L = 10\Omega$ .

**Power Dissipation**

It is possible to exceed the +125°C maximum junction temperatures under certain load and power-supply conditions. It is therefore important to calculate the maximum junction temperature ( $T_{JMAX}$ ) for all applications to determine if power supply voltages, load conditions, or

package type need to be modified to remain in the safe operating area. These parameters are related in Equation 1:

$$T_{JMAX} = T_{MAX} + (\theta_{JA} \times PD_{MAXTOTAL}) \quad (EQ. 1)$$

where:

- $PD_{MAXTOTAL}$  is the sum of the maximum power dissipation of each amplifier in the package ( $PD_{MAX}$ )
- $PD_{MAX}$  for each amplifier can be calculated in Equation 2:

$$PD_{MAX} = 2 \times V_S \times I_{SMAX} + (V_S - V_{OUTMAX}) \times \frac{V_{OUTMAX}}{R_L} \quad (EQ. 2)$$

where:

- $T_{MAX}$  = Maximum ambient temperature
- $\theta_{JA}$  = Thermal resistance of the package
- $PD_{MAX}$  = Maximum power dissipation of 1 amplifier
- $V_S$  = Supply voltage
- $I_{MAX}$  = Maximum supply current of 1 amplifier
- $V_{OUTMAX}$  = Maximum output voltage swing of the application
- $R_L$  = Load resistance

SOT-23 Package Family

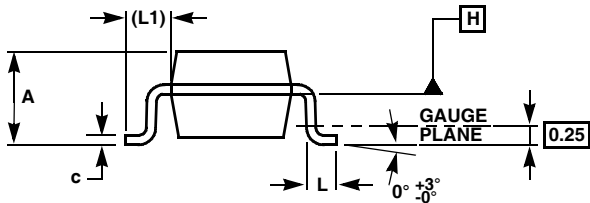
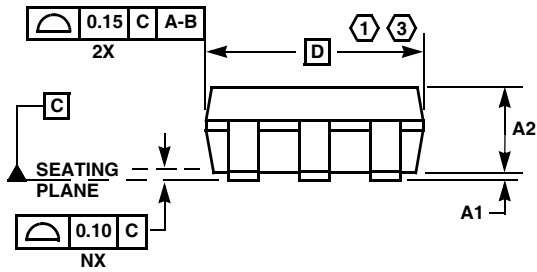
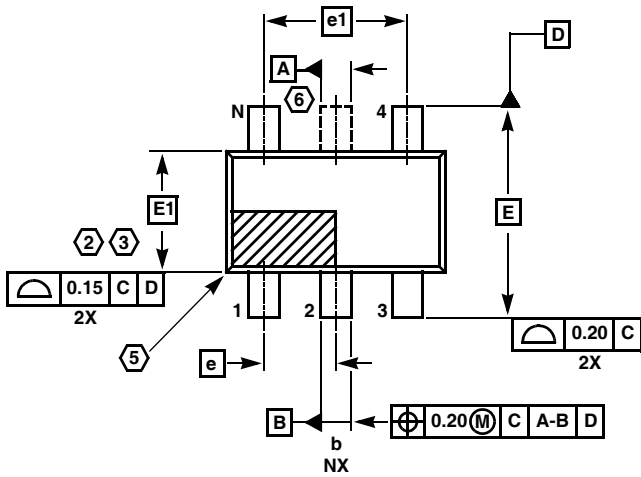

MDP0038

SOT-23 PACKAGE FAMILY

SYMBOL	MILLIMETERS		TOLERANCE
	SOT23-5	SOT23-6	
A	1.45	1.45	MAX
A1	0.10	0.10	±0.05
A2	1.14	1.14	±0.15
b	0.40	0.40	±0.05
c	0.14	0.14	±0.06
D	2.90	2.90	Basic
E	2.80	2.80	Basic
E1	1.60	1.60	Basic
e	0.95	0.95	Basic
e1	1.90	1.90	Basic
L	0.45	0.45	±0.10
L1	0.60	0.60	Reference
N	5	6	Reference

Rev. F 2/07

NOTES:

1. Plastic or metal protrusions of 0.25mm maximum per side are not included.
2. Plastic interlead protrusions of 0.25mm maximum per side are not included.
3. This dimension is measured at Datum Plane "H".
4. Dimensioning and tolerancing per ASME Y14.5M-1994.
5. Index area - Pin #1 I.D. will be located within the indicated zone (SOT23-6 only).
6. SOT23-5 version has no center lead (shown as a dashed line).

Ultra Thin Dual Flat No-Lead Plastic Package (UTDFN)

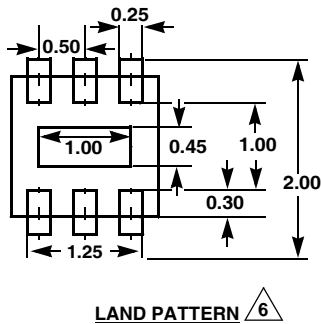
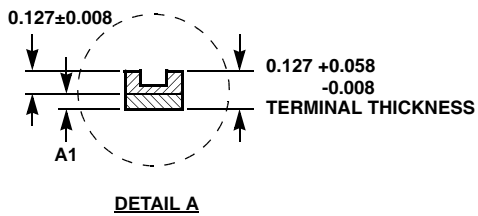
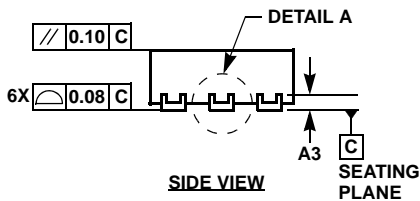
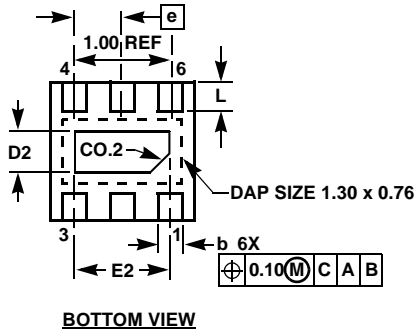
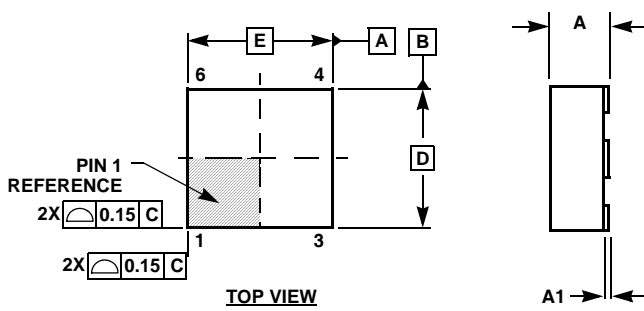

L6.1.6x1.6A

6 LEAD ULTRA THIN DUAL FLAT NO-LEAD PLASTIC PACKAGE

SYMBOL	MILLIMETERS			NOTES
	MIN	NOMINAL	MAX	
A	0.45	0.50	0.55	-
A1	-	-	0.05	-
A3	0.127 REF			-
b	0.15	0.20	0.25	-
D	1.55	1.60	1.65	4
D2	0.40	0.45	0.50	-
E	1.55	1.60	1.65	4
E2	0.95	1.00	1.05	-
e	0.50 BSC			-
L	0.25	0.30	0.35	-

Rev. 1 6/06

NOTES:

1. Dimensions are in mm. Angles in degrees.
2. Coplanarity applies to the exposed pad as well as the terminals. Coplanarity shall not exceed 0.08mm.
3. Warpage shall not exceed 0.10mm.
4. Package length/package width are considered as special characteristics.
5. JEDEC Reference MO-229.
6. For additional information, to assist with the PCB Land Pattern Design effort, see Intersil Technical Brief TB389.

Small Outline Package Family (SO)

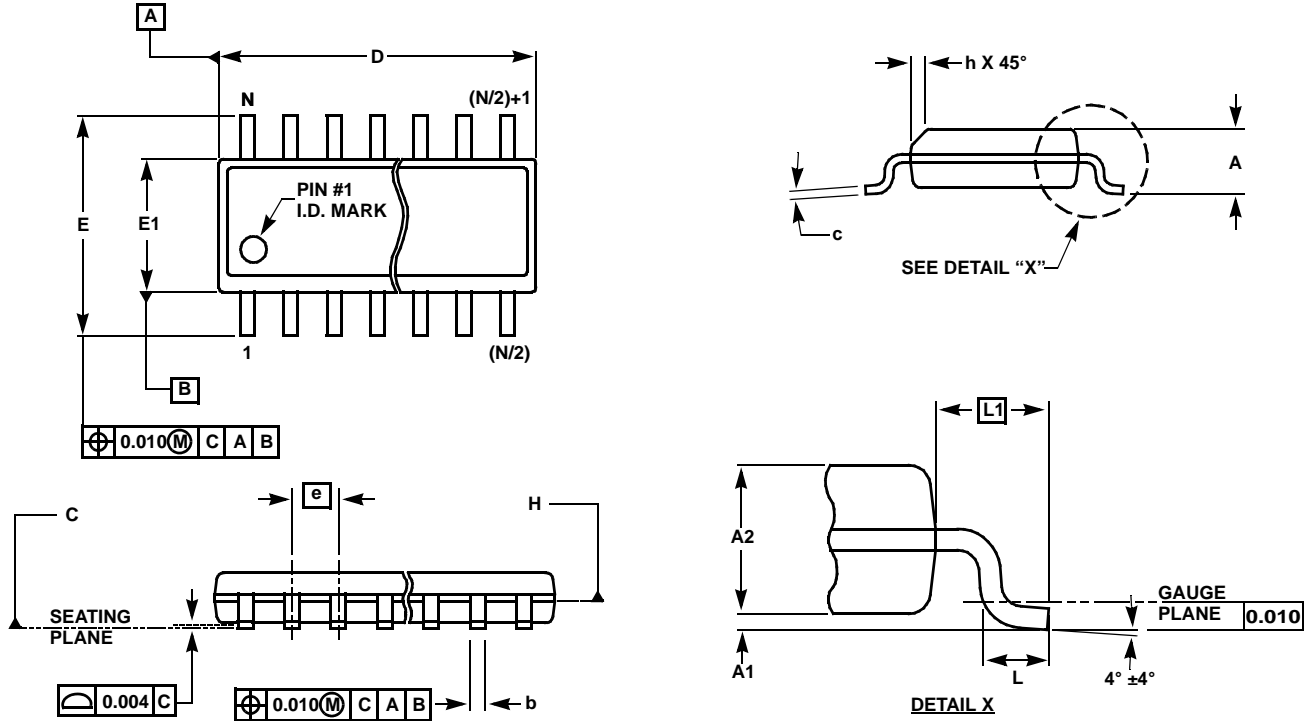

MDP0027

SMALL OUTLINE PACKAGE FAMILY (SO)

SYMBOL	INCHES							TOLERANCE	NOTES
	SO-8	SO-14	SO16 (0.150")	SO16 (0.300") (SOL-16)	SO20 (SOL-20)	SO24 (SOL-24)	SO28 (SOL-28)		
A	0.068	0.068	0.068	0.104	0.104	0.104	0.104	MAX	-
A1	0.006	0.006	0.006	0.007	0.007	0.007	0.007	$\pm 0.003$	-
A2	0.057	0.057	0.057	0.092	0.092	0.092	0.092	$\pm 0.002$	-
b	0.017	0.017	0.017	0.017	0.017	0.017	0.017	$\pm 0.003$	-
c	0.009	0.009	0.009	0.011	0.011	0.011	0.011	$\pm 0.001$	-
D	0.193	0.341	0.390	0.406	0.504	0.606	0.704	$\pm 0.004$	1, 3
E	0.236	0.236	0.236	0.406	0.406	0.406	0.406	$\pm 0.008$	-
E1	0.154	0.154	0.154	0.295	0.295	0.295	0.295	$\pm 0.004$	2, 3
e	0.050	0.050	0.050	0.050	0.050	0.050	0.050	Basic	-
L	0.025	0.025	0.025	0.030	0.030	0.030	0.030	$\pm 0.009$	-
L1	0.041	0.041	0.041	0.056	0.056	0.056	0.056	Basic	-
h	0.013	0.013	0.013	0.020	0.020	0.020	0.020	Reference	-
N	8	14	16	16	20	24	28	Reference	-

Rev. M 2/07

NOTES:

1. Plastic or metal protrusions of 0.006" maximum per side are not included.
2. Plastic interlead protrusions of 0.010" maximum per side are not included.
3. Dimensions "D" and "E1" are measured at Datum Plane "H".
4. Dimensioning and tolerancing per ASME Y14.5M-1994

Ultra Thin Quad Flat No-Lead Plastic Package (UTQFN)

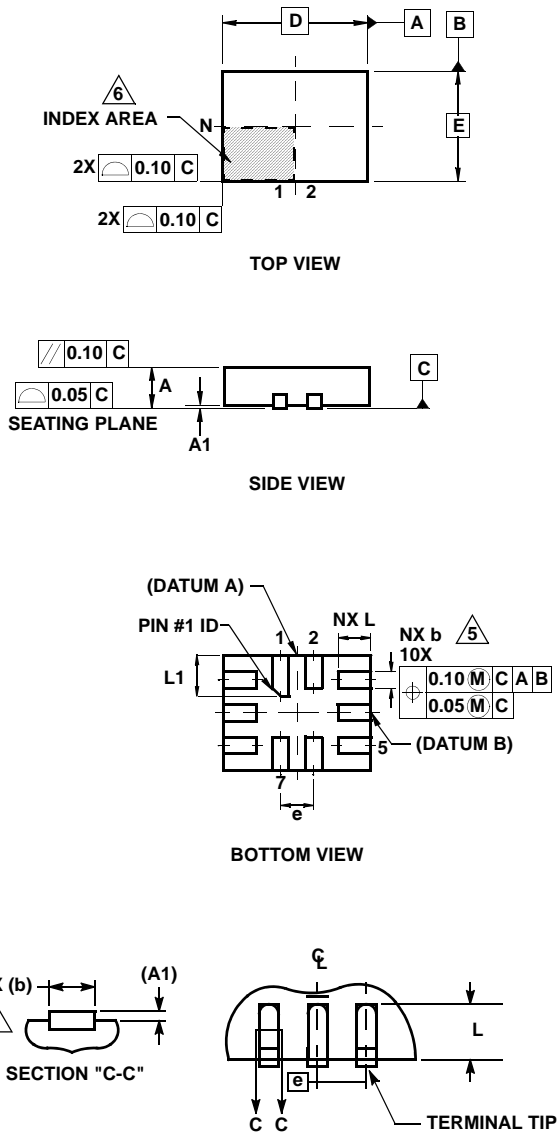

**L10.1.8x1.4A**  
10 LEAD ULTRA THIN QUAD FLAT NO-LEAD PLASTIC PACKAGE

SYMBOL	MILLIMETERS			NOTES
	MIN	NOMINAL	MAX	
A	0.45	0.50	0.55	-
A1	-	-	0.05	-
A3	0.127 REF			-
b	0.15	0.20	0.25	5
D	1.75	1.80	1.85	-
E	1.35	1.40	1.45	-
e	0.40 BSC			-
L	0.35	0.40	0.45	-
L1	0.45	0.50	0.55	-
N	10			2
Nd	2			3
Ne	3			3
θ	0	-	12	4

Rev. 3 6/06

NOTES:

1. Dimensioning and tolerancing conform to ASME Y14.5-1994.
2. N is the number of terminals.
3. Nd and Ne refer to the number of terminals on D and E side, respectively.
4. All dimensions are in millimeters. Angles are in degrees.
5. Dimension b applies to the metallized terminal and is measured between 0.15mm and 0.30mm from the terminal tip.
6. The configuration of the pin #1 identifier is optional, but must be located within the zone indicated. The pin #1 identifier may be either a mold or mark feature.
7. Maximum package warpage is 0.05mm.
8. Maximum allowable burrs is 0.076mm in all directions.
9. JEDEC Reference MO-255.
10. For additional information, to assist with the PCB Land Pattern Design effort, see Intersil Technical Brief TB389.

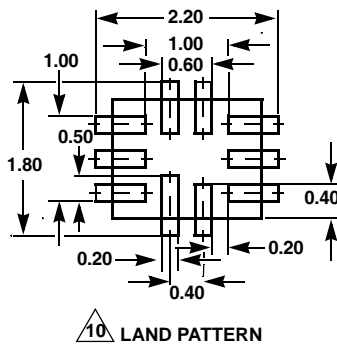

Mini SO Package Family (MSOP)

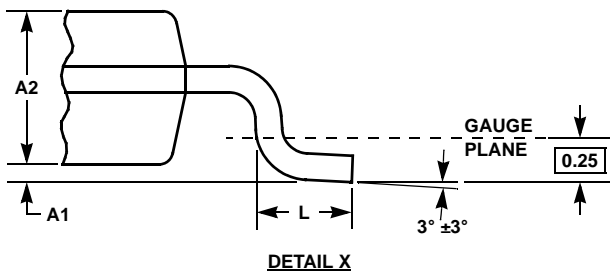
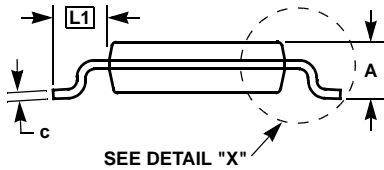
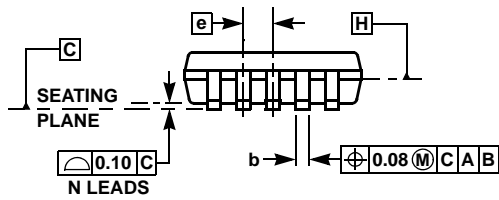
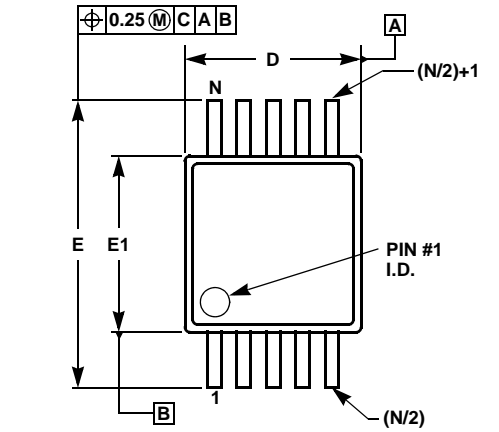

MDP0043

MINI SO PACKAGE FAMILY

SYMBOL	MILLIMETERS		TOLERANCE	NOTES
	MSOP8	MSOP10		
A	1.10	1.10	Max.	-
A1	0.10	0.10	±0.05	-
A2	0.86	0.86	±0.09	-
b	0.33	0.23	+0.07/-0.08	-
c	0.18	0.18	±0.05	-
D	3.00	3.00	±0.10	1, 3
E	4.90	4.90	±0.15	-
E1	3.00	3.00	±0.10	2, 3
e	0.65	0.50	Basic	-
L	0.55	0.55	±0.15	-
L1	0.95	0.95	Basic	-
N	8	10	Reference	-

Rev. D 2/07

NOTES:

1. Plastic or metal protrusions of 0.15mm maximum per side are not included.
2. Plastic interlead protrusions of 0.25mm maximum per side are not included.
3. Dimensions "D" and "E1" are measured at Datum Plane "H".
4. Dimensioning and tolerancing per ASME Y14.5M-1994.

All Intersil U.S. products are manufactured, assembled and tested utilizing ISO9000 quality systems. Intersil Corporation's quality certifications can be viewed at [www.intersil.com/design/quality](http://www.intersil.com/design/quality)

*Intersil products are sold by description only. Intersil Corporation reserves the right to make changes in circuit design, software and/or specifications at any time without notice. Accordingly, the reader is cautioned to verify that data sheets are current before placing orders. Information furnished by Intersil is believed to be accurate and reliable. However, no responsibility is assumed by Intersil or its subsidiaries for its use; nor for any infringements of patents or other rights of third parties which may result from its use. No license is granted by implication or otherwise under any patent or patent rights of Intersil or its subsidiaries.*

For information regarding Intersil Corporation and its products, see [www.intersil.com](http://www.intersil.com)