

SSAC70

Solid State AC Controller(Anti-Parallel Thyristor-Thyristor Modules)

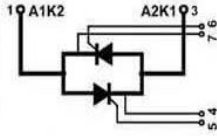
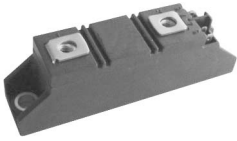

Type	V _{RSM} V _{DSM} V	V _{RRM} V _{DRM} V
SSAC70GK08	900	800
SSAC70GK12	1300	1200
SSAC70GK14	1500	1400
SSAC70GK16	1700	1600
SSAC70GK18	1900	1800
SSAC70GK20	2100	2000
SSAC70GK22	2300	2200
SSAC70GK24	2500	2400

Dimensions in mm (1mm=0.0394")

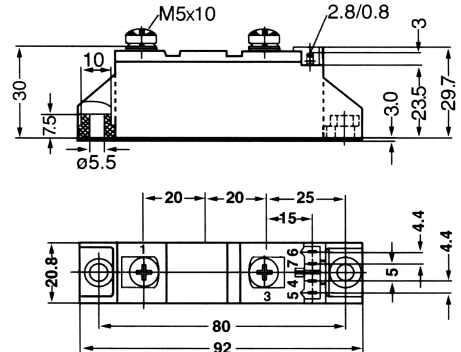

Symbol	Test Conditions	Maximum Ratings	Unit	
I _{TRMS} , I _{FRMS} I _{TAVM} , I _{FAVM}	T _{VJ} =T _{VJM} T _C =85°C; 180° sine	180 70	A	
I _{TSM} , I _{FSM}	T _{VJ} =45°C V _R =0 t=10ms (50Hz), sine t=8.3ms (60Hz), sine	1600 1700	A	
	T _{VJ} =T _{VJM} V _R =0 t=10ms(50Hz), sine t=8.3ms(60Hz), sine	1450 1550		
∫i ² dt	T _{VJ} =45°C V _R =0 t=10ms (50Hz), sine t=8.3ms (60Hz), sine	13500 12600	A ² s	
	T _{VJ} =T _{VJM} V _R =0 t=10ms(50Hz), sine t=8.3ms(60Hz), sine	10600 10250		
(di/dt) _{cr}	T _{VJ} =T _{VJM} f=50Hz, t _p =200us V _D =2/3V _{DRM} I _G =0.45A di _G /dt=0.45A/us	repetitive, I _T =250A non repetitive, I _T =I _{TAVM}	150 500	A/us
	T _{VJ} =T _{VJM} ; R _{GK} =∞; method 1 (linear voltage rise)	V _{DR} =2/3V _{DRM}	1000	V/us
P _{GM}	T _{VJ} =T _{VJM} I _T =I _{TAVM}	t _p =30us t _p =300us	10 5	W
P _{GAV}			0.5	W
V _{RGM}			10	V
T _{VJ} T _{VJM} T _{stg}			-40...+125 125 -40...+125	°C
V _{ISOL}	50/60Hz, RMS I _{ISOL} ≤1mA	t=1min t=1s	3000 3600	V~
M _d	Mounting torque (M5) Terminal connection torque (M5)		2.5-4.0/22-35 2.5-4.0/22-35	Nm/lb.in.
Weight	Typical including screws		90	g

SSAC70

Solid State AC Controller(Anti-Parallel Thyristor-Thyristor Modules)

Symbol	Test Conditions	Characteristic Values	Unit
I_{RRM}, I_{DRM}	$T_{VJ}=T_{VJM}; V_R=V_{RRM}; V_D=V_{DRM}$	5	mA
V_T, V_F	$I_T, I_F=320A; T_{VJ}=25^{\circ}C$	1.65	V
V_{TO}	For power-loss calculations only ($T_{VJ}=125^{\circ}C$)	0.85	V
r_T		3.2	$m\Omega$
V_{GT}	$V_D=6V;$ $T_{VJ}=25^{\circ}C$ $T_{VJ}=-40^{\circ}C$	1.5 1.6	V
I_{GT}	$V_D=6V;$ $T_{VJ}=25^{\circ}C$ $T_{VJ}=-40^{\circ}C$	100 200	mA
V_{GD}	$T_{VJ}=T_{VJM};$ $V_D=2/3V_{DRM}$	0.2	V
I_{GD}		10	mA
I_L	$T_{VJ}=25^{\circ}C; t_p=10\mu s; V_D=6V$ $I_G=0.45A; di_G/dt=0.45A/\mu s$	450	mA
I_H	$T_{VJ}=25^{\circ}C; V_D=6V; R_{GK}=\infty$	200	mA
t_{gd}	$T_{VJ}=25^{\circ}C; V_D=1/2V_{DRM}$ $I_G=0.45A; di_G/dt=0.45A/\mu s$	2	μs
t_q	$T_{VJ}=T_{VJM}; I_T=150A; t_p=200\mu s; -di/dt=10A/\mu s$ $V_R=100V; dv/dt=20V/\mu s; V_D=2/3V_{DRM}$	185	μs
Q_S	$T_{VJ}=T_{VJM}; I_T, I_F=50A; -di/dt=6A/\mu s$	170	μC
I_{RM}		45	A
R_{thJC}	per thyristor/diode; DC current per module	0.3 0.15	K/W
R_{thJK}	per thyristor/diode; DC current per module	0.5 0.25	K/W
d_s	Creeping distance on surface	12.7	mm
d_A	Strike distance through air	9.6	mm
a	Maximum allowable acceleration	50	m/s^2

FEATURES

- * International standard package
- * Copper Base Plate with Inter-DCB
- * Planar passivated chips
- * Isolation voltage 3600 V~

APPLICATIONS

- * DC motor control
- * Softstart AC motor controller
- * Light, heat and temperature control

ADVANTAGES

- * Space and weight savings
- * Simple mounting with two screws
- * Improved temperature and power cycling
- * Reduced protection circuits

SSAC70

Solid State AC Controller (Anti-Parallel Thyristor-Thyristor Modules)

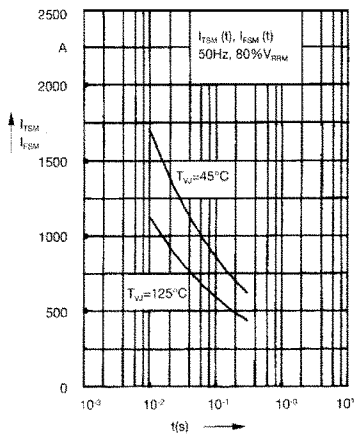

Fig. 1 Surge overload current
 I_{TSM}, I_{FSM} : Crest value, t : duration

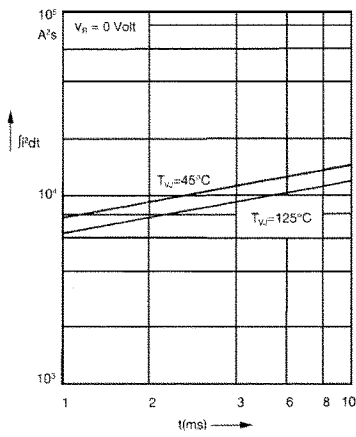

Fig. 2 $\int I^2 dt$ versus time (1-10 ms)

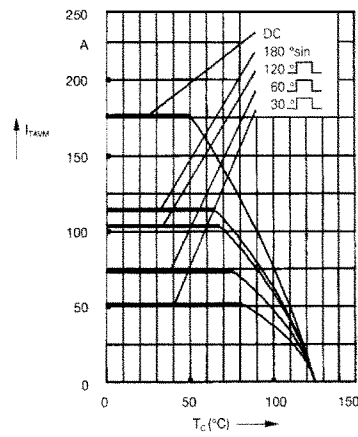

Fig. 2a Maximum forward current at case temperature

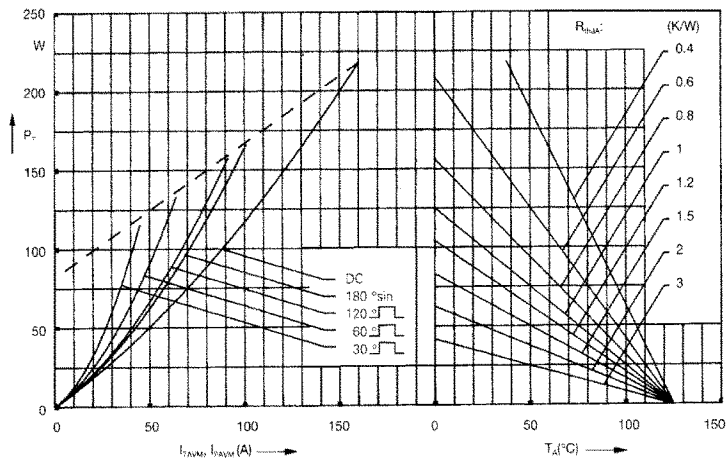

Fig. 3 Power dissipation versus on-state current and ambient temperature (per thyristor or diode)

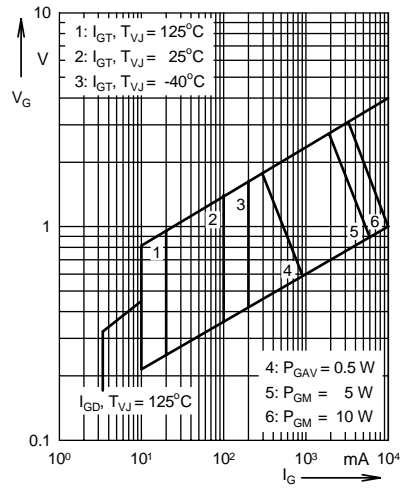

Fig. 4 Gate trigger characteristics

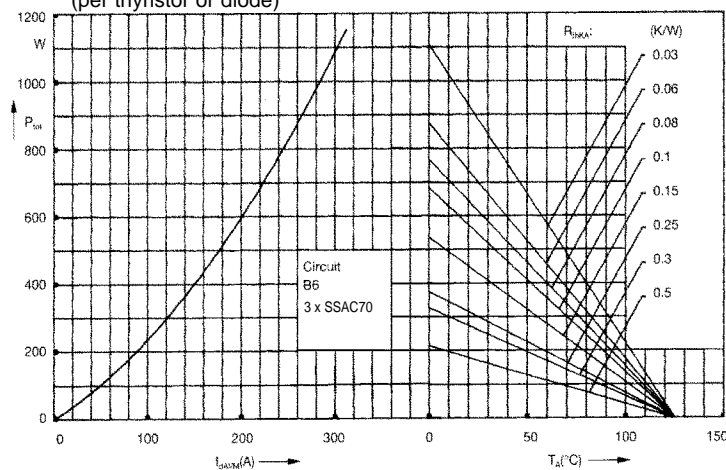

Fig. 5 Three phase rectifier bridge: Power dissipation versus direct output current and ambient temperature

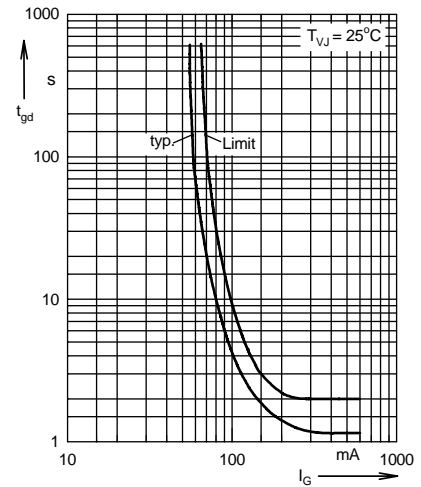

Fig. 6 Gate trigger delay time

SSAC70

Solid State AC Controller(Anti-Parallel Thyristor-Thyristor Modules)

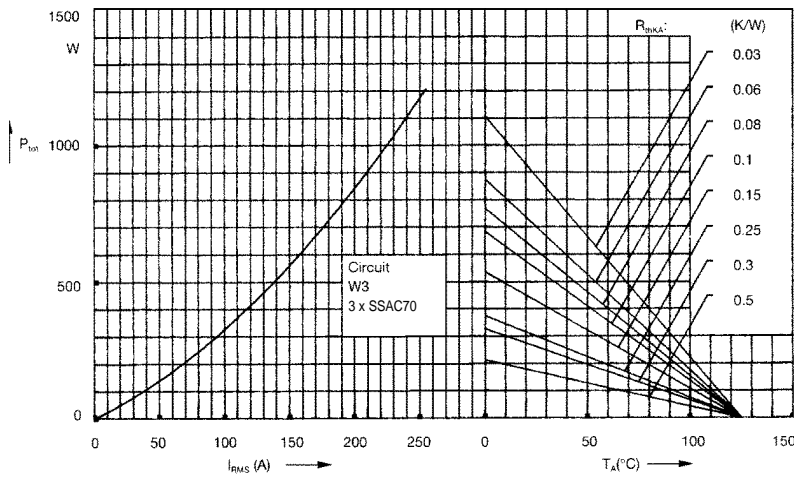

Fig. 7 Three phase AC-controller:
Power dissipation versus RMS
output current and ambient
temperature

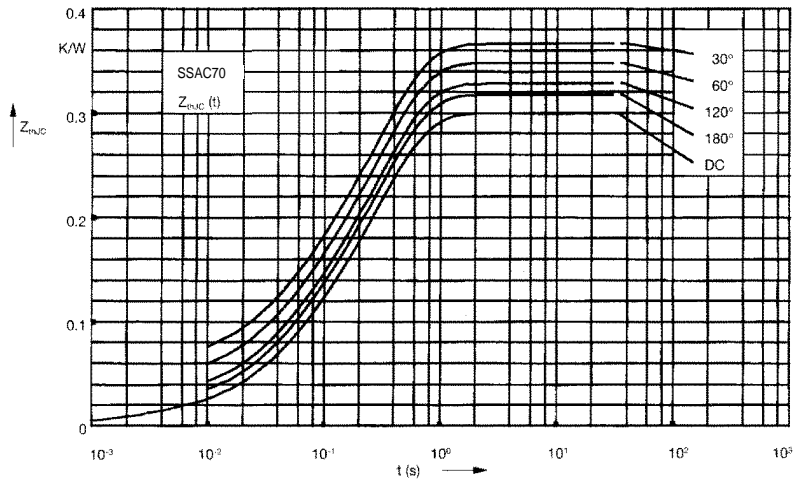

Fig. 8 Transient thermal impedance
junction to case (per thyristor or
diode)

R_{thJC} for various conduction angles d:

d	R_{thJC} (K/W)
DC	0.3
180°C	0.31
120°C	0.33
60°C	0.35
30°C	0.37

Constants for Z_{thJC} calculation:

i	R_{thi} (K/W)	t_i (s)
1	0.008	0.0019
2	0.054	0.047
3	0.238	0.3

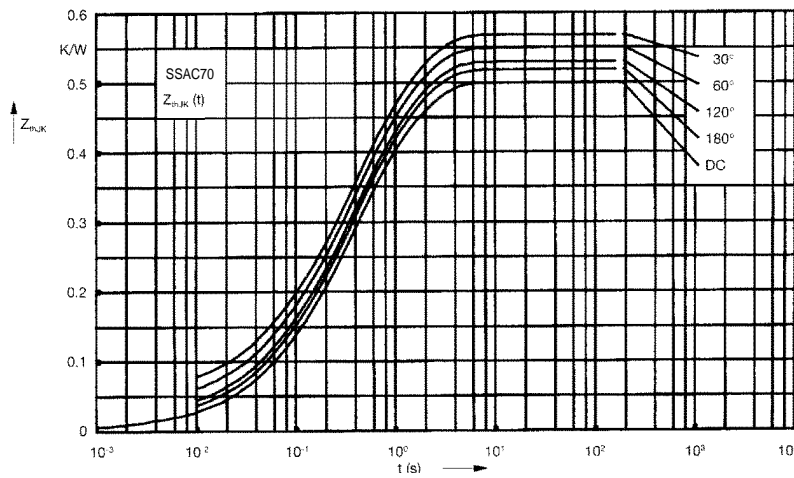

Fig. 9 Transient thermal impedance
junction to heatsink (per thyristor
or diode)

R_{thJK} for various conduction angles d:

d	R_{thJK} (K/W)
DC	0.5
180°C	0.51
120°C	0.53
60°C	0.55
30°C	0.57

Constants for Z_{thJK} calculation:

i	R_{thi} (K/W)	t_i (s)
1	0.008	0.0019
2	0.054	0.047
3	0.238	0.3
4	0.2	1.25